

LokSound V4.0

Instruction manual

4. Edition, May 2012

From firmware 4.6.

LokSound V4.0
LokSound micro V4.0
LokSound XL V4.0
LokSound V4.0 M4



M4



RailCom plus



1. Declaration of Conformity	5	6.8. Locomotives without Interface	14
2. WEEE-Declaration	5	6.8.1. Wiring Diagram for LokSound / LokSound micro	15
3. Important Notes – Please read this chapter first... 5		6.8.2. Wiring Diagram for LokSound XL	16
4. How this manual helps you	6	6.8.2.1. Wiring to LGB gear boxes	16
5. Introduction – The LokSound Family..... 7		6.8.2.2. Wiring to an LGB interface	17
5.1. The Members of the LokSound Family	7	6.8.2.3. Wiring to the Aristocraft® interface.....	17
5.1.1. LokSound V4.0	7	6.8.2.4. Multi-pin decoder	17
5.1.2. LokSound micro V4.0	7	6.8.3. Colour Coding by Märklin®	18
5.1.3. LokSound XL V4.0	7	6.8.4. Motor and Track Connections	18
5.1.4. LokSound V4.0 M4	7	6.8.4.1. Connecting DC and Coreless Motors	18
5.1.5. An overview of the LokSound V4.0 decoders.....	8	6.8.4.2. Connecting Universal Motors/HAMO-Conversions	18
5.2. General Properties of all Decoders.....	9	6.9. Connecting the Speaker.....	19
5.2.1. Operating Modes.....	9	6.9.1. Connecting several speakers	19
5.2.2. Motor Control	9	6.9.2. Dual speaker output	19
5.2.3. Sound functions.....	9	6.9.3. External volume control	20
5.2.3.1. Functions for Steam locomotives.....	10	6.10. Connecting Additional Functions	20
5.2.3.2. Functions for Diesel locomotives	10	6.10.1. Overload Protection of Function Outputs (Blinking)	20
5.2.3.3. Functions for Electric locomotives	10	6.10.1.1. Suitable Light Bulbs.....	21
5.2.3.4. LokProgrammer	10	6.10.1.2. Micro incandescent lamps wired to LokSound XL	21
5.2.4. Analogue Mode.....	10	6.10.2. Using LEDs.....	21
5.2.5. Functions	10	6.10.3. Connecting the Light Outputs, AUX1 and AUX2	22
5.2.6. Programming	11	6.10.4. Using AUX3 and AUX4	22
5.2.7. Operational Reliability	11	6.10.4.1. LokSound with 21MTC Interface.....	22
5.2.8. Protection	11	6.10.4.2. LokSound V4.0 M4 - LokSound PluX interface	22
5.2.9. Future built-in	11	6.10.5. AUX5 through to AUX 10	22
6. Installing the Decoder	11	6.10.5.1. Servo outputs	23
6.1. Requirements for Installation.....	11	6.10.6. Suitable Smoke Generators.....	23
6.2. Installing the Decoder	11	6.10.7. Connecting a wheel sensor.....	24
6.3. Locomotives with 8-pin NEM 652-Interface.....	11	6.10.7.1. HALL Sensor IC	24
6.4. Locomotives with 6-pin NEM 651-Interface.....	12	6.10.7.2. Reed switch sensor	24
6.5. Locomotives with 21MTC Interface	13	6.10.7.3. Additional sensor inputs	25
6.5.1. Connecting C-Sine motors („SoftDrive-Sinus“)	14	6.11. Connecting Capacitors.....	25
6.6. Locomotives with Next18 Interface	14	6.11.1. LokSound H0, LokSound micro decoders	25
6.7. Locomotives with PluX interface	14	6.11.2. “PowerPack”	26
		7. Initial Operation.....	27
		7.1. Factory Default Values.....	27
		7.2. Digital Operating Modes	27

7.2.1. DCC operation mode.....	27
7.2.1.1. DCC Speed Steps („flashing lights“)	27
7.2.1.2. Auto-detection of DCC Speed Steps	27
7.2.2. Motorola® mode.....	28
7.2.2.1. 28 Speed Steps.....	28
7.2.2.2. Extended Motorola® Address Range	28
7.2.3. Selectrix® mode.....	28
7.2.4. M4 mode.....	29
7.3. Analogue Mode.....	29
7.3.1. Analogue DC operation.....	29
7.3.2. Analogue AC Operation.....	29
8. Decoder Settings (Programming)	30
8.1. Adjustable Properties of Decoders	30
8.1.1. M4 Configuration Range	31
8.1.2. M4, the mfx® compatible protocol by ESU	31
8.1.3. Configuration Variables (CVs)	32
8.1.3.1. Standardisation in the NMRA.....	32
8.1.3.2. Bits and Bytes	32
8.2. Programming with popular Digital Systems.....	32
8.2.1. Programming with DCC Systems	32
8.2.2. Programming with the ESU ECoS.....	33
8.2.3. Programming with Märklin® 6021	33
8.2.3.1. Changing to the Programming Mode	33
8.2.3.2. Short Mode	33
8.2.3.3. Long Mode	34
8.2.4. Programming with the Märklin® Mobile Station®	34
8.2.5. Programming with the Märklin® Central Station	35
8.2.6. Programming with the ESU LokProgrammer	35
8.2.7. Programming with the ROCO® Multimaus	35
8.2.8. Programming with the ROCO® LokMaus II.....	36
9. Address Settings	37
9.1. Short Addresses in DCC Mode.....	37
9.2. Long Addresses in DCC Mode	37
9.3. Motorola® Address	38
9.3.1. Consecutive addresses for more functions	38
9.4. Addresses in M4 mode	38
9.5. Turning off data protocols not needed.....	39
10. Adapting the Driving Characteristics	39
10.1. Acceleration and Deceleration	39
10.1.1. Switching Acceleration / Deceleration	39
10.1.2. Shunting Mode.....	39
10.2. Starting Voltage, Maximum and Medium Speed	39
10.3. Speed Curve	40
10.4. Changing between Operating Modes	41
10.4.1. Changing from Digital to Analogue DC	41
10.4.2. Changing from Digital to Analogue AC	41
10.4.3. Changing from Analogue to Digital (directional bit)	41
10.4.4. Changing from Digital to Digital	41
10.4.5. Changing modes with Analogue Mode turned off	42
10.5. Brake Sectors.....	42
10.5.1. DC Brake Mode.....	42
10.5.2. Märklin® Brake Mode	42
10.5.3. Selectrix® Diode Brake Sector.....	43
10.5.4. Lenz® ABC Brake Mode	43
10.5.4.1. ABC “slow approach” section	43
10.5.4.2. ABC detection threshold.....	43
10.6. Constant Brake Distance	43
10.6.1. Linear Braking Distance	44
10.6.2. Constant Linear Braking Distance.....	44
10.6.3. Push-pull trains	44
10.6.4. Braking at speed step 0.....	44
10.7. Settings for Analogue Operation.....	44
10.7.1. DC Analogue Operation	45
10.7.2. AC Analogue Operation	45
10.8. Motor brake	45
10.9. Configure the PowerPack „Switch off” time	46
11. Motor Control	46
11.1. Adjusting Load Compensation	46
11.1.1. Parameter for frequently used Motors.....	46
11.1.2. Adjustments for other Motors / „Fine Tuning”	47
11.1.2.1. Parameter „K”	47
11.1.2.2. Parameter „I”	47
11.1.2.3. Reference Voltage	47
11.1.2.4. Parameter „K slow”	47

Contents

11.1.2.5. Parameter „I slow“	47
11.1.2.6. Adaptive Regulation Frequency	48
11.1.3. Automatic calibration of the motor	48
11.2. Turning off Load Compensation	49
11.3. Adapting Load Control Frequency	49
11.4. Dynamic Drive Control: Up and Down the Hill	49
11.5. Settings for the C-Sinus Motor	49
12. Function outputs	50
12.1. Physical function outputs	50
12.2. Allocation of Function Buttons (Function Mapping)	50
12.2.1. Index CV access	50
12.2.2. Function Mapping Chart	51
12.2.2.1. Conditions block	53
12.2.2.2. Physical function outputs	54
12.2.2.3. Logical outputs	55
12.2.2.4. Sound functions	56
12.2.3. Standard mapping - LokSound V4.0 / micro decoder	57
12.2.4. Standard mapping - LokSound V4.0 M4	61
12.2.5. Standard mapping - LokSound XL V4.0	61
12.2.5.1. Programming LokSound with Central Station 2	61
12.2.5.2. Example	61
12.2.6. Allocation of Function Keys with LokProgrammer	61
12.3. Special Effects on Function Outputs	62
12.3.1. Switching on Outputs and Different Options	62
12.3.2. Adjusting the Lighting Effects	63
12.3.3. Grade Crossing holding time	66
12.3.4. Flash Rate	66
12.3.5. Automatic Switch-off	66
12.3.6. Switch-on and switch-off delay	66
12.3.7. Digital Couplers	67
12.3.7.1. „Coupler“ Mode	67
12.3.8. Servo settings	67
12.3.8.1. Servo with coupler function	67
12.4. Analogue Settings	68
12.5. LGB® Pulse Sequence Mode	68
12.6. Swiss Headlight Mode	68
13. Adjusting the Sound Effects	69
13.1. Adjust the sound volume	69
13.1.1. Adjusting the master volume	69
13.1.2. Single sounds tables	69
13.2. Prime mover startup delay	71
13.3. Manual notching (for Diesel-electric locomotives only)	71
13.4. Synchronising the steam chuff	72
13.4.1. Minimum distance of steam chuffs	72
13.5. Random sounds	72
13.6. Adjusting the braking sound threshold	73
13.7. Sound fader	73
14. Decoder Reset	73
14.1. With DCC Systems or 6020/6021	73
14.2. With Märklin® systems (mfx® decoders)	73
14.3. With the ESU LokProgrammer	73
15. Special Functions	74
15.1. Directional Bit	74
15.2. Saving the status of functions	74
16. RailCom®	74
16.1. RailCom® Plus	75
16.1.1. Prerequisites for RailCom® Plus	75
17. Firmware Update	75
18. Accessories	75
18.1. Switching the Centre pick-up	75
18.2. HAMO Magnets	75
18.3. Wire Harnesses with 8-pole or 6-pole Socket	76
18.4. Mounting Adapter 21MTC	76
19. Support and Assistance	76
21.1. LokSound decoders	78
22. Appendix	86
22.1. Programming Long Addresses	86
22.1.1. Write address	86
22.1.2. Read out address	86

Important Notes

1. Declaration of Conformity

We, ESU electronic solutions ulm GmbH & Co. KG, Edisonallee 29, D-89231 Neu-Ulm, Germany, declare in sole responsibility that the product

Product description: LokSound V4.0, LokSound micro V4.0, LokSound XL V4.0, LokSound V4.0 M4

Part number: 544xx, 554xx, 564xx, 548xx, 558xx, 568xx, 644xx, 654xx, 664xx, 545xx

complies with all relevant regulations of the Directive for Electromagnetic Compatibility (2004/108/EG). The following harmonised standards have been applied:

EN 55014-1:2006 + A1:2009: Electromagnetic Compatibility - requirements for household appliances, electric tools, and similar apparatus - Part 1: Emission - Product

EN 55014-2:1997 + A1:2001 + A2:2008: Electromagnetic Compatibility - Requirements for household appliances, electric tools, and similar apparatus - Part 2: Immunity - Product family standard.

2. WEEE-Declaration

Disposal of obsolete electrical and electronic equipment (as practised in the European Union and other European countries with dedicated collection systems).



This mark on the product, the packaging or the relevant documentation indicates that this product must not be treated like household waste. Instead this product should be disposed of at a suitable collection point for recycling of electrical and electronic appliances. Thus you contribute to avoid negative impact on the environment and people's health that could be caused by inappropriate disposal. Recycling of materials contributes to preserve our natural resources. For more information regarding recycling of this product, please contact your local administration, your waste collection service or the dealer / shop where you purchased this product.

3. Important Notes – Please read this chapter first

We congratulate you to your purchase of an ESU LokSound decoder. This manual will guide you step by step through the features of your LokSound decoder.

Please read this manual carefully. Although the LokPilot has been design as a robust device an incorrect connection may lead to faults or even to the destruction of the device. Avoid any "costly" experiments.



- The LokSound is exclusively intended for use with model train layouts only. It may only be operated with the components listed here. Any other use is not permitted.
- Any wiring has to be carried out while power is disconnected. Please make sure that no voltage reaches the locomotive while converting it, above all not accidentally.
- Avoid mechanical force or pressure on the decoder.
- Do not remove the heat shrink sleeve on the decoder.
- Make sure that neither the LokSound decoder nor any blank wire ends may come into contact with the engine chassis (risk of short circuit). Cover any blank ends of unused wires.

Copyright 1998 - 2012 by ESU electronic solutions ulm GmbH & Co KG. Electrical characteristics and dimensions are subject to change without prior notice. All rights reserved. ESU might not be held responsible for any damage or consequential loss or damage caused by inappropriate use of the product, abnormal operating conditions, unauthorized modifications to the products etc...

Not suitable for children under 14 years of age. Inappropriate use may result in injury due to sharp points and edges.

Märklin® and mfx® is a registered trademark of the company Gebr. Märklin® and Cie. GmbH, Göppingen, Germany. RailCom is a registered trademark of the company Lenz Elektronik GmbH, Giessen, Germany.

All the other trade marks are owned by their respective right holders. ESU electronic solutions ulm GmbH & Co. KG continues to develop the products according to the company's politics. Therefore, ESU reserves the right to carry out changes and improvements on the products listed in this manual at any time and without any advanced note.

Duplications and reproductions of this documentation are strictly forbidden and need to be allowed by ESU in writing.

How this manual helps you

- Never solder on the circuit board, extend cables if necessary.
- Never wrap the decoder in insulation tape, since this may cause overheating.
- Adhere to the wiring principles as outlined in this manual for wiring any external components. Other circuitry may cause damage to the LokSound.
- Make sure that no wires are squeezed or cut by the model's transmission parts when reassembling the engine.
- Any power supply must be protected by a fuse or circuit breaker to avoid any potential hazards such as burning cables in case of a short circuit. Only use transformers specifically designed for model trains that bear the VDE/EN marks.
- Never operate the LokSound unattended. The LokSound is not a (children's) toy.
- Do not expose to wet and humid conditions.
- Handle the speaker with extreme care: Do not touch the membrane or apply pressure! Solder the speaker connections quickly and only at the intended contacts!

4. How this manual helps you

This manual is divided into several chapters that show you step-by-step how to install a LokSound decoder.

Chapter 5 provides an overview over the characteristics of each type of LokSound decoder.

Chapter 6 describes installation of the decoder in detail. Please make yourself familiar with the type of motor and the type of interface installed in your locomotive prior to working through chapters 6.2. to 6.7.

You can operate LokSound Decoders with most commercially available control systems for model trains.

Chapter 7 provides an overview which digital and analogue systems can drive LokSound decoders and which special issues to consider.



You will find the factory default settings for the function buttons in chapter 7.1.

You may adjust the default settings of your LokSound decoder as desired. Chapters 8 to 16 explain which parameters are adjustable and how to do it.



We recommend, that you at least read chapters 8 and 9 regarding address settings as well as chapter 11 concerning motor control in order to be able to adapt your LokSound decoder optimally to your model locomotive.

Chapter 20 lists all technical data as well as supported CVs and will assist you in case of questions.



If not stated otherwise all information refers to all types of the LokSound family. Should one particular decoder not support a specific function, then this is clearly mentioned.

5. Introduction – The LokSound Family

5.1. The Members of the LokSound Family

All LokSound V4.0 decoders have been completely redeveloped on the basis of their predecessors' excellent properties and they are "better" in many respects. All decoders of the LokSound V4.0 family expand the capabilities of their forerunners by further functions. These developments further improve the driving characteristics, the operational reliability, the flexibility of the decoders as well as the sound functions. Compared to their predecessors, LokSound V4.0 Decoders ensure a far more realistic sound experience. Combined with 8 (!) sound channels, the decoder makes a sound volume up to four times louder than before possible. The LokSound decoder is the first choice for any sophisticated model train enthusiast that places great value on excellent load control, outstanding driving characteristics at low speed and the best sound possible. LokSound decoders automatically detect the operating mode and are suitable for all commonly used motors. LokSound decoders of the fourth generation offer you flexibility and reliability that you would expect from a state-of-the-art decoder. Future standards do not represent a problem either: due to the flash technology, you can update the decoder at any time.

In order to suit the different scales and the related current draw of the model locomotives, all LokSound V4.0 decoders come in various options that we now would like to introduce to you.

5.1.1. LokSound V4.0

The LokSound V4.0 revolutionises the authentic model railway operation. It combines a sound module as well as a multiprotocol decoder in an intelligent manner. The LokSound V4.0 is a multiprotocol decoder. It supports the Märklin® / Motorola® format, the DCC-format and Selectrix®.

It can also work on analogue DC or AC layouts. Thus, it is ideally suitable for mixed Motorola® / DCC environments.

Due to its manifold lighting and sound functions and its adaptability to different applications, it is the perfect all-rounder for your H0 locomotives.

5.1.2. LokSound micro V4.0

The LokSound micro V4.0 is a small power pack: Despite its small dimensions it supports beside DCC also Motorola® and Selectrix® and offers a maximum current draw of 0.75A. Thus it is ideal for the small scales with little room for decoders. The sound features are just as impressive as those of its "big brother".

5.1.3. LokSound XL V4.0

The LokSound XL V4.0 is suitable for the larger gauges such as 0 gauge, G gauge and 1 gauge and has been optimised to operate with models in these gauges. It is the first and only decoder worldwide that supports four data protocols. Besides DCC with RailComPlus®, Motorola® and Selectrix® it also supports the M4 data format and can automatically report to the matching Märklin® central units. Due to its 12 function outputs as well as 4 outputs for RC servos and a powerful motor end stage it leaves nothing to be desired. While the double end stage assures high volume sounds in the garden dirty track and their related problems are a thing of the past due to the integral PowerPack.

5.1.4. LokSound V4.0 M4

The LokSound V4.0 M4 is ideal for everyone who does not want to do without the automatic mfx® registration on a Märklin® central station. Like the LokSound V4.0 this decoder supports besides M4 the formats DCC with RailComPlus, Motorola® and Selectrix® and can be operated on analogue layouts. The LokSound V4.0 M4 fits into all popular H0 locomotives and can be programmed with DCC command stations and also with Märklin® central units. Both LokSound V4.0 M4 and LokSound V4.0 offer comprehensive lighting effects, control of digital couplers, flexible function mapping as well as 8 channel sound.

An overview of the LokSound V4.0 decoders

5.1.5. An overview of the LokSound V4.0 decoders

	LokSound V4.0					LokSound micro V4.0					LokSound XL V4.0		LokSound V4.0 M4				
DCC Operation	Ok					Ok					Ok		Ok				
Motorola® Operation	Ok					Ok					Ok		Ok				
M4 Operation (mfx® compatible)	-					-					Ok		Ok				
Selectrix® Operation	Ok					Ok					Ok		Ok				
Analogue DC Operation	Ok					Ok					Ok		Ok				
Analogue AC Operation	Ok					-					Ok		Ok				
DCC programming mode	Ok					Ok					Ok		Ok				
Programming with 6021, Mobile/ Central Station®	Ok					Ok					Ok		Ok				
M4 programming including automatic recognition	-					-					Ok		Ok				
RailCom® Plus	Ok					Ok					Ok		Ok				
ABC brake mode	Ok					Ok					Ok		Ok				
Continuous motor current	1.1A					0.75A					4.0A		1.1A				
Function output current	4/250mA + 2 Logic					4/150mA + 2 Logik					12/250mA		6/250mA				
Integrated PowerPack	-					-					Ok		-				
Optional connection for PowerPack buffer capacitor	Ok					Ok					-		Ok				
Connection type	8pin	21MTC	PluX12	PluX16	6pin	6pin	Next18	PluX12	8pin	Screwing terminals	PIN connector	8pin	21MTC	PluX12	PluX16	6pin	
	Harness	Direct	Harness	Direct	Harness	Harness	Direct	Harness	Harness			Harness	Direct	Harness	Direct	Harness	
Article number	54400	54499	55400	56498	56499	54800	54898	55800	56899	54500	54599	64400	64499	65400	66498	66499	

5.2. General Properties of all Decoders

5.2.1. Operating Modes

All LokSound V4.0 decoders are true multi-protocol decoders with automatic detection of the operating mode „on-the-fly.“ The decoder analyses the track signal and filters out the part that is reserved for it. Changing from digital to analogue and back represents no problem whatsoever. This is important in case your e.g. fiddle yard still works in analogue mode. Furthermore, all LokSound decoders support the relevant brake modes such as ROCO®, Lenz® or Märklin® and stop as intended.

Especially the ABC brake sections are suitable for a simple stop in front of the signal. LokSound decoders achieve the maximum compatibility with the operating system in order to enable you to simulate even some unusual operational requirements.

The LokSound V4.0 supports and automatically detects the DCC protocol with 14, 28, or 128 speed steps. Of course, operation with the long 4-digit addresses is possible as well.

Contrary to the original Märklin®-decoders, LokSound V4.0 decoders support up to 255 addresses and 28 speed steps in Motorola® mode. With the appropriate command station such as the ESU ECoS, you can expand the system limits of the Motorola® system considerably.

Furthermore, all LokSound V4.0 decoders support RailComPlus®. A RailComPlus®-compatible command station immediately recognises a LokSound V4.0 decoder fully automatically. The decoder will transfer all of its important data to the command station. Finally, you will never have to look for a loco address once again or carry out any function mapping!

LokSound XL V4.0 and LokSound V4.0 M4 also support operation with M4 and register automatically with Märklin® mfx® central units.

5.2.2. Motor Control

The most important function of digital decoders is motor control. All LokSound V4.0 decoders are designed for universal use and therefore can control all commonly available DC motors, regard-

less if they are by ROCO®, Fleischmann®, Brawa®, Mehano®, Bemo®, LGB®, Hübner®, Märklin® or others.

Coreless motors (such as Faulhaber® or Maxon®) also work fine with LokSound. You may continue to use any universal motors provided you replace the stator coils with a permanent magnet. You will find more info on this topic in chapter 6.7.4.2.

Fifth-generation load compensation works with 20 resp. 40 kHz and assures extremely silent operation, particularly with coreless motors. Due to 10-bit technology, your locomotives will crawl at a snail's pace if so desired. Load compensation is easily adjustable to various motor and gear combinations (compare with chapter 11).

With Dynamic Drive Control (DCC), you can limit the influence of load control. Thus, you can control your locomotive in small throttle notches for instance in the yard or on turnouts while the locomotive responds like the prototype at high speed on the main line (for instance when climbing a gradient). In other words, if you do not change the throttle setting then the locomotive will slow down up the hill, as does the prototype. There is more info on this in chapter 11.4.

The minimum and maximum speed of the LokSound V4.0 is adjustable by setting two points which can be optionally adjusted by a speed table with 28 entries.

Due to unique load compensation by ESU, there are no visible jerks between speed steps – even in 14-speed-step-mode.

5.2.3. Sound functions

LokSound V4.0 decoders inherit their reference for good sound from the successful LokSound family, introduced since 1999.

Compared to all its forerunners, the sound part of the fourth generation decoders has been significantly extended with the aim to offer you a much more prototypical sound experience. So all LokSound V4.0 decoders come with a 32MBit memory chip on which you are able to store twice as much sounds than before. All of the sounds saved are original sounds recorded from the real prototype loco.

ESU records the original sounds directly from the locos using the latest recording equipment. After recording, the sounds are digi-

General Properties of all Decoders

tally remastered for the best audio possible by ESU sound engineers before they are finally played on a decoder.

LokSound V4.0 decoders have a completely new designed audio amplifier concept. The new „Class D“ last stage amplifier with a power output of 3 Watts (resp. 13 Watts for the LokSound XL V4.0) provides, in combination with all-new high performance loudspeakers, a full sound on your layout. 8 independent sound channels allow various sound pictures to meet one's own expectations. Up to 28 additional sounds can be triggered via functions keys. With random sounds as well as wheel-synchron brake squealing your model railroad hobby grows more realistic than ever before.

5.2.3.1. Functions for Steam locomotives

All ESU LokSound decoders are distinctly audible: Steam locomotives reproduce changing chuffs. Those are coupled to motor control and are load-dependant. When accelerating, chuffs sound harsh, while, when the throttle is closed, only rod-clatter is discernible. The reproduction hereby is so faithful that you can differentiate between the rhythms of a two-, three, or four cylinder loco. The rhythm can either be triggered by an external sensor, absolutely r.p.m.- synchronous, or via back E.M.F (load compensation), speed step dependant.

5.2.3.2. Functions for Diesel locomotives

Diesel engines come in various designs, which are all correctly reproduced: Dieselhydraulic locos first rev up, before they start moving. Engine r.p.m.-sound is in ratio to speed. LokSound decoders allow your loco, prototype like, to move only when engine r.p.m is high enough. This is only possible through the entity of sound module and decoder. When accelerating or straining, the sound is more intensive, while, when you close the throttle, the prime mover revs down to idle. Diesel-electrical locos keep their prime mover r.p.m nearly constant, but you hear the soft whine of the electro motors.

5.2.3.3. Functions for Electric locomotives

But even Electric locomotives are a treat for the ears: Beside the fan noise, the compressors, or the oil coolers, you hear the whine of the electro motors, the cracks of main switches, or gear noises. Beside these sound variations, you can activate sounds anytime per function key. Thus you can whistle, sound the horn or bell to your heart's content, in front of railroad crossings, or tunnels. Length of sound is up to you.

5.2.3.4. LokProgrammer

All sounds of the LokSound decoders can be exchanged, transferred and deleted with the help the ESU LokProgrammer. ESU already offers hundreds of pre-created sound projects free for download. This enables specialists to create their own sounds or even change available ESU projects.

5.2.4. Analogue Mode

Quite a few LokSound decoders replace analogue directional relays. Therefore, you can not only set the starting speed and the maximum speed as well as pre-select which functions should be active in analogue mode: even load compensation works in analogue mode!

5.2.5. Functions

Standard features for LokSound V4.0 decoders include the following features: acceleration and brake times can be separately adjusted and switched, and of course, you can switch the shunting mode. The brightness of all function outputs can be separately set and allocated to the desired function buttons (function mapping).

There is a wide range of options: dimmer, flickering firebox, gyro-light and mars-light, flash and double flash, blinker and alternate blinker as well as switch functions with timers (e.g.: for Telex) and a special coupler function for remote controlled couplers by Krois® and ROCO® including the automatic pushing and pulling.

Furthermore LokSound XL decoders can also control up to 4 RC servos directly.

The unique and once more improved ESU function mapping enables you to allocate every function to the function buttons F0 to

F28; even multiple allocations are possible. You will find more info on this in chapter 12.

5.2.6. Programming

Where intended, LokSound decoders support all programming modes including POM (Programming-On-the-Main). You can use any NMRA-DCC compatible command station for this purpose. Even with the Märklin® central units 6020®, 6021®, Mobile Station® and Central Station® all settings are adjusted electronically. Most LokSound V4.0 decoders support a simple-to-use programming procedure.

Owners of the ESU ECoS enjoy an even more comfortable method of programming: you can read all possible settings in plain text on the large display and easily adjust them – even during operation!

LokSound V4.0 M4 and LokSound XL V4.0 will be automatically detected and read by all Märklin® mfx® central units and can be graphically programmed with them.

5.2.7. Operational Reliability

LokSound decoders store the current operating status. Thanks to this data storage, the decoder will start again as quickly as possible after a service interruption. The LokSound XL's built-in PowerPack, which also can be optionally installed into some decoders, assures continuous power even in case of poor electrical contact or critically laid tracks.

5.2.8. Protection

All function outputs as well as the motor output have protection against overload and short circuit. We want you to enjoy your LokSound decoders for a long time.

5.2.9. Future built-in

All LokSound V4.0 decoders are suitable for firmware updates due to the flash memory. You may add new software functions at a later stage.

6. Installing the Decoder

6.1. Requirements for Installation

The locomotive must be in perfect operating condition prior to the conversion: Only a locomotive with faultless mechanical properties and smooth running characteristics in analogue mode is worth converting to digital. Check and replace all wear and tear parts such as motor brushes, wheel contacts, light bulbs etc., if necessary.



Please take note of the remarks in chapter 3 in order to prevent possible damage of the decoder during installation!

6.2. Installing the Decoder

The components on the decoder must under no circumstances touch any metal parts of the locomotive since this could lead to short circuits and damage or even destruction of the decoder. Therefore, all LokSound decoders (with the exception of the ones with the 21MTC or PluX interface) come with a protective shrink sleeve.



Never wrap the decoder in insulating tape. If there is no ventilation around the decoder, it may lead to a heat build-up and ultimately to the destruction of the decoder. Rather apply the insulating tape to the metal parts of the locomotive.

Mount the decoder at a suitable location. In most model locomotives, there is a dedicated space for the decoder. To hold the decoder in place use double sided adhesive tape or some (just a little) hot glue.

6.3. Locomotives with 8-pin NEM 652-Interface

Some LokSound V4.0 decoders are supplied with an 8-pin interface as per NEM 652 (refer to Fig 1). Installation in locomotives with this interface is particularly easy:

- Remove the locomotive body. Please observe the instructions in the manual of your locomotive!
- Remove the dummy plug from the socket and keep it in a suitable place for later use.

Installing the Decoder

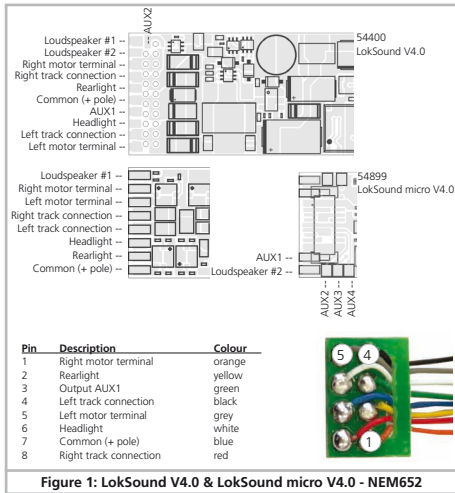

Figure 1: LokSound V4.0 & LokSound micro V4.0 - NEM652

- Insert the plug of the decoder in such a way that pin 1 of the plug (this is the side with the red / orange wires) sits next to the corner of the socket that is usually marked with *, +, • or 1. Please make sure that the pins are straight when inserting the plug.



Do not rely on the assumption that the wires of the harness have to face in a certain direction: the only reliable reference is the marking of pin 1.

6.4. Locomotives with 6-pin NEM 651-Interface

Some LokSound V4.0 decoders have a 6-pin NEM 651 plug (as

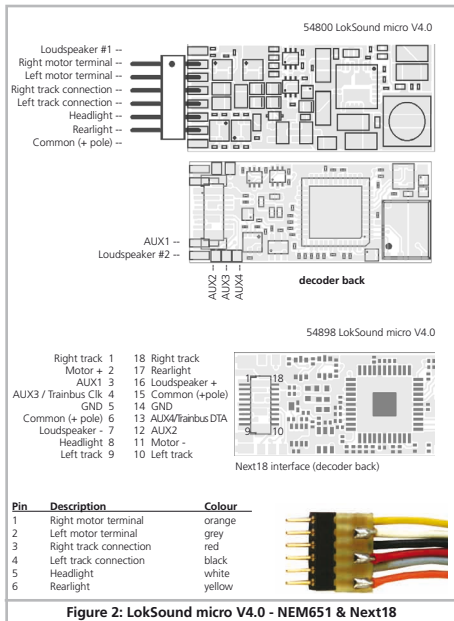
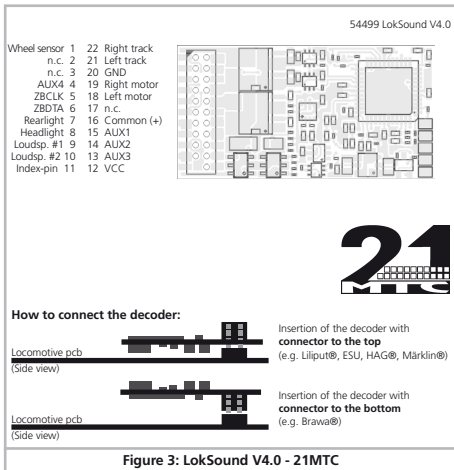

Figure 2: LokSound micro V4.0 - NEM651 & Next18

Installing the Decoder

per Fig. 2). Installation in locomotives with this interface is particularly easy:

- Remove the locomotive body.
- Remove the dummy plug from the socket and keep it in a suitable place for later use
- Insert the plug of the decoder in such a way that pin 1 of the plug (this is the side with the red / orange wires) sits next to the corner of the socket that is usually marked with *, +, • or 1. Please make sure that the pins are straight when inserting the plug.



6.5. Locomotives with 21MTC Interface

Some LokSound decoders are available with a variant of the 21MTC interface as per Fig. 3. Installation in locomotives with this interface is particularly easy since the plug-socket connector facilitates the mechanical fixing as well.

! Please make sure that the impedance of the installed loudspeakers is really 4 or 8 Ohms! Some locomotives have installed 100 Ohms loudspeakers which have originally been created for LokSound V3.5 decoders.

- Remove the locomotive body. Please observe the instructions in the manual of your locomotive!
- Remove the dummy plug from the socket and keep it in a suitable place for later use
- Search for the missing pin in the plug on the circuit board of the locomotive. The missing pin serves as the marker. Memorise its location.
- You can insert the decoder in two ways: either the pins are put through the decoder; the socket of the decoder remains visible after installation (mounting on top) or the decoder is inserted in such a way that the pins go straight into the socket. Once the decoder sits in the socket, the socket is hidden from view. This method is common for Brawa® locomotives.
- Which of the two mounting positions is the correct one depends solely on the locomotive. The position of the marker-pin is the crucial indicator.
- Plug the decoder into the socket in such a way that the locomotive interface corresponds with the decoder.
- Do not apply too much pressure when inserting the plug. The decoder must go in without force.
- Check if the decoder sits correctly.

Installing the Decoder

6.5.1. Connecting C-Sine motors („SoftDrive-Sinus“)

The LokSound decoder cannot drive the newer Märklin® models with C-Sine motors (also called „SoftDrive-Sinus“) directly. To facilitate this, a circuit board supplied ex works with the locomotive is required. This circuit board will be controlled by a LokSound decoder. Märklin® uses the 21MTC interface installed on this circuit board and thus utilises the normal motor commands from the decoder or a SUSU interface for the exchange of information.

The LokSound V4.0 with the 21MTC interface is suitable for controlling the C-Sine control electronics provided some parameters are set accordingly. Chapter 11.5. explains the necessary steps.

6.6. Locomotives with Next18 Interface

Some LokSound micro decoders are shipped with an 18-pin Next18 interface. More information about how to install the decoder is given in chapter 6.5.

6.7. Locomotives with PluX interface

Some LokSound decoders are supplied with a PluX16 plug. These decoders can also be installed in locomotives with a PluX22 interface. One position on the multi-pin plug of the decoder has no pin (index pin). This position should be marked in the locomotive. Please observe the correct seating of the decoder on the PluX socket!

6.8. Locomotives without Interface

All LokSound decoders have an interface (plug). There is no „wires-only“ version. Please remove the plug at the end of the harness should this become necessary.



Please do not extend any wires at the decoder end. If necessary use an extension harness (also refer to chapter 18).

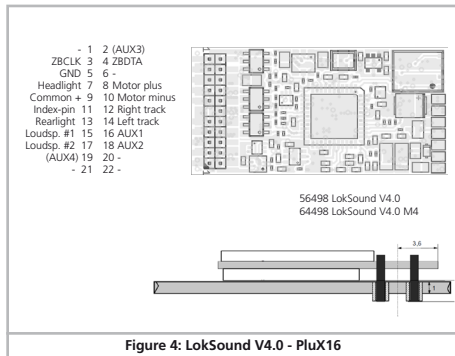

Wiring Diagram for LokSound

6.8.1. Wiring Diagram for LokSound / LokSound micro

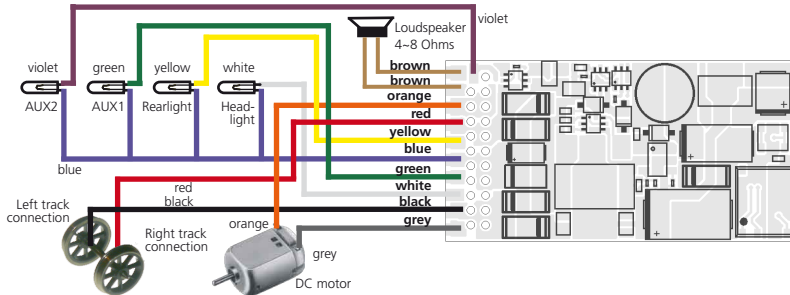

Figure 5: Wiring diagram for LokSound V4.0 (Wiring example)

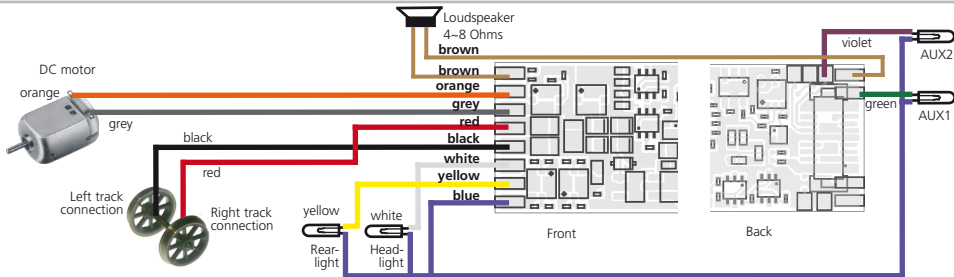
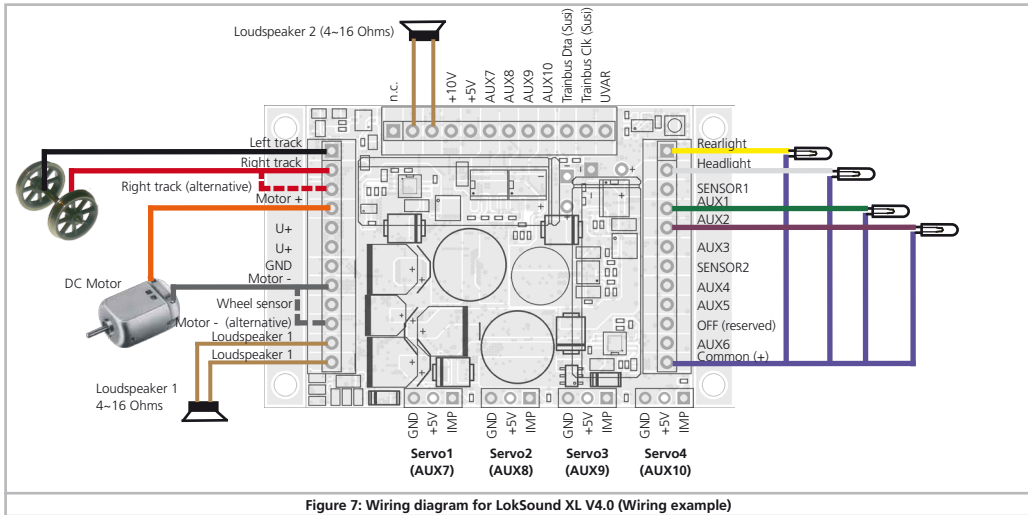

Figure 6: Wiring diagram for LokSound micro V4.0 (Wiring example)

Wiring Diagram for LokSound

6.8.2. Wiring Diagram for LokSound XL



6.8.2.1. Wiring to LGB gear boxes

The decoder can be wired directly to suitable LGB® locomotives with the LGB® interface cable. Motor, light and auxiliary functions can be controlled. The cable with the part number 55026 is available from LGB®. Remove the dummy plug from the interface cable and screw the ends into the terminals of the decoder after having

removed the insulation at the ends of the wires. Set the DIP switch at the interface according to the instructions from LGB.



Non-compliance may lead to the destruction of the decoder!

Installing the Decoder

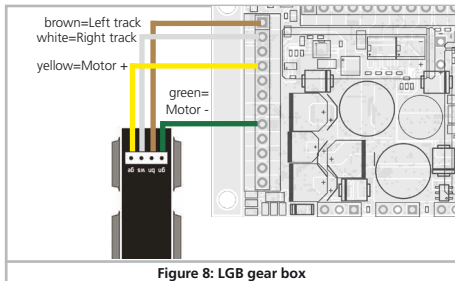

6.8.2.2. Wiring to an LGB interface

More modern LGB® locomotives have a digital interface and thus are ready for installing digital components.

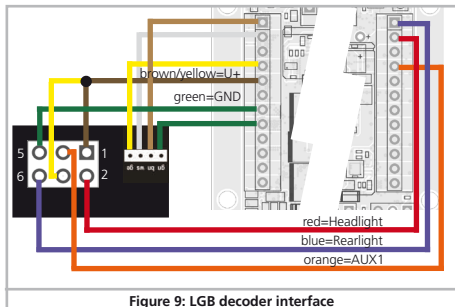

6.8.2.3. Wiring to the Aristocraft® interface

Many Aristocraft locomotives have a digital interface which represents a manufacturer's standard only. They are ready for the installation of digital components.

The wiring is shown in figure 10:

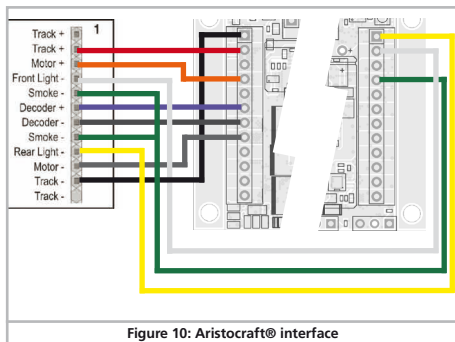

6.8.2.4. Multi-pin decoder

LokSoundXL V4.0 decoders are supplied with multi-pin plug connectors. They are intended for Kiss and KM-1 models and are also suitable for some Märklin® 1 gauge locomotives. The LokSound XL V4.0 decoder can directly replace the factory installed LokSound XL V3.5 decoders. Controlling the installed smoke generators is also possible. We will publish suitable pre-configured project files on our homepage

Installing the Decoder

6.8.3. Colour Coding by Märklin®

Märklin® uses a different colour coding system compared to the DCC colours. Please refer to figure 11 for more information.

Description	Märklin® colour	ESU colour (NMRA DCC standard)
AC: Power pick up show (Center rail)	red	red
DC: Right track connection		
AC: Outside rails	brown	black
DC: Left track connection		
Left motor terminal	blue	orange
Right motor terminal	green	grey
Common (rectified track voltage) (+Pole) for function outputs	orange	blue
Function output Rearlight	yellow	yellow
Function output Headlight	grey	white
Function output AUX1	brown/red	green
Function output AUX2	brown/green	violet
Function output AUX3	brown/yellow	-
Function output AUX4	brown/white	-

Figure 11: Colour coding by Märklin® in contrast to DCC colours

6.8.4. Motor and Track Connections

Firstly, please cut all wires installed in the locomotive. Take special care to remove any connections to the chassis (ground): the motor leads must be positively potential-free, in other words they may not have any contact to the chassis or body or the wheels and wheel contacts.

It is particularly easy to overlook such connections in Fleischmann® locomotives.

Make notes of which motor lead connects the motor with the right and the left wheel contact. This avoids mistakes and assures that your locomotive runs in the right direction.



Please check all connections with an Ohmmeter. Search for short circuits, particularly between the motor leads and the wheel contacts.

- Connect the red wire to the right rail pickup or the centre pick up in AC models.
- Connect the black wire to the left rail pickup or the chassis in AC models.
- Connect the orange wire with the motor terminal, which originally lead to the right wheel pick up (centre pick up in AC models).
- The grey wire goes to the terminal, which originally connected to the left rail (chassis for AC models).

6.8.4.1. Connecting DC and Coreless Motors

You may use all DC motors commonly used for model trains provided they do not exceed the current limit of the decoder.

In some cases with the 5-pole High Performance Drive by Märklin®, you may find three anti-interference capacitors.

The two capacitors connected directly to the motor leads and the motor housing MUST be removed (also refer to Fig. 9 on the following page).

6.8.4.2. Connecting Universal Motors with HAMO-Conversions

Do not wire universal motors installed in many older Märklin® locomotives (also known as AC motors) directly to LokSound decoders. You must modify the motor by first installing permanent magnets – so called HAMO magnets.

You may purchase these magnets from your ESU dealer.

We supply three types of magnets. Please refer to chapter 18.2. for more information regarding motor conversions with permanent magnets.

Connecting the Speaker

6.9. Connecting the Speaker

Every LokSound V4.0 decoder is shipped with an appropriate loudspeaker that is connected with both the dark brown braids. Firstly, you need to unsolder the speaker before you install it into the locomotive. It must be installed in such a way that the sound waves are not unduly blocked.



Please handle speakers with extreme care: don't apply pressure or touch the membrane! The speaker's magnets are very powerful! Keep all metal items away and secure the speaker firmly when soldering. The soldering iron may pull the speaker due the magnetic field and destroy it.

For LokSound V4.0 decoders you can use loudspeakers (also combinations) with a total impedance of 4 – 16 Ohms. We recommend to use the 4 Ohms impedance by ESU as they are tuned to LokSound V4.0 decoders. However, we advise against using the previous 100 Ohm impedance speakers since the sound volume would be too low.

Make sure that you use a small soldering iron (max. 20W) and only heat the marked contact spots of the speaker. Polarity is not important. The correct position of the speaker is crucial to achieve high quality sound. A speaker that is installed without a sound chamber will not generate good sound. Therefore carefully select the location and sound chamber for the speaker.

6.9.1. Connecting several speakers

When wiring several speakers, the speaker polarity is important. If a speaker is wired "backwards" compared to another speaker, each speaker's membrane will move in phase opposition. This will lead to a sound wave cancellation resulting in a very poor and extremely low sound volume!

As some speakers do not provide any polarity mark, you need to test the phase position before the final installation of the speaker!

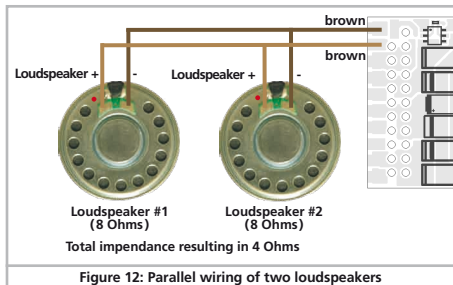

6.9.2. Dual speaker output

The LokSound XL V4.0 has two speaker outputs working with about 10V each. They are independent of each other and are suitable for speakers of differing size and impedance. In order to ensure optimal operation of this dual end stage, please observe the following hints:

- If you install 4 Ohm speakers you should only wire one output. The maximum output power is 12W.
- If you wish to use both speaker outputs each speaker should have an impedance of 8 Ohms or higher. The maximum output in this configuration is 2x 6 Watts.

Installing the decoder

- In case of an overload the end stage switches off automatically as soon as the sound becomes distorted.
- Both speaker outputs deliver identical sound data.

6.9.3. External volume control

You may connect a separate volume controller (potentiometer) to each speaker output. Please use a potentiometer with an impedance of 100 kOhm and a minimum power rating of 0.1W (e.g.: PT 10 LV, available from Conrad or Reichelt Elektronik).



In order to avoid any disturbing noises please keep the wires between decoder and volume controller as short as possible.

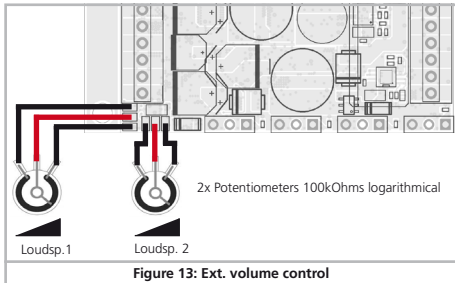

6.10. Connecting Additional Functions

You can wire any kind of load such as light bulbs, LEDs (light emitting diodes), smoke generators or similar devices to the function outputs provided the maximum current draw is less than that of the decoder output.



The permitted maximum current draw per function output is listed in chapter 20 under „Technical Data.“



Please make sure that the load does not exceed the permitted maximum current and there are no short circuits. The outputs of the LokSound have protection but if an external voltage is applied, the outputs may suffer damage or destruction.

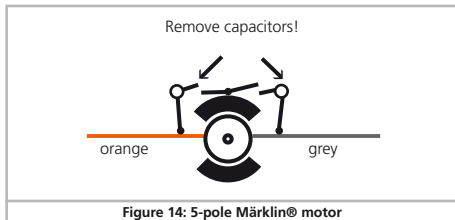

6.10.1. Overload Protection of Function Outputs (Blinking)

The function outputs of LokSound decoders have electronic protection against overload and short circuit. The decoder keeps checking the sum of all function output currents. If the current is too high, the decoder will switch off the outputs. After about 1 second, the decoder tries to switch them on again. Should the current still be too high – perhaps due to a short circuit – the same procedure starts again.

When using light bulbs (incandescent lamps) please note the following: they draw a very high „inrush current“ when they are switched on, that becomes lower after a few moments. Therefore, it can happen with 12V bulbs that the headlights „flash“ briefly during switch-on and then extinguish due to the overload protection of the decoder. The lights will be shortly switch on and off again in a one-second cycle. This results from a much too high inrush current of the bulbs; the decoder is not able to distinguish between the bulbs' high inrush current and an overload. Therefore it is important to install the correct bulbs.

Installing the decoder

6.10.1.1. Suitable Light Bulbs



Only install bulbs rated 16V or higher and with a nominal current draw, that does not exceed 50 mA.



Many older models by ROCO® and Fleischmann® have 12V bulbs installed. They draw a high current, become very hot, and may cause damage to the locomotive. Replace them with 16V bulbs.

6.10.1.2. Micro incandescent lamps wired to LokSound XL V4.0

The LokSound XL V4.0 decoder has a suitable for direct connection of micro incandescent lamps. The decoder has an integral voltage regulator for this purpose. The default setting is 1.8V designed for long life of 3V lamps. Do not connect the return wire of the lamp to U+ but rather to the terminal marked "UVAR".

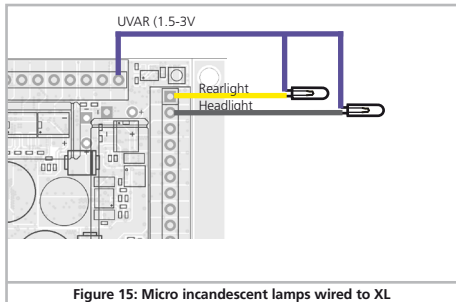

Figure 15: Micro incandescent lamps wired to XL

You may change the voltage setting by exchanging a resistor. An SMD resistor is required. Type 0805, power rating 0.125W:

Voltage	R124
1.5V	33 kOhms
2.5V	unsolder
3.0V	48 kOhms, unsolder R125



The maximum load of the UVAR output is 500mA.

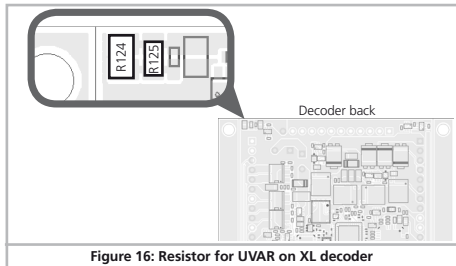

Figure 16: Resistor for UVAR on XL decoder

6.10.2. Using LEDs

If you like to use LEDs, then a resistor must be wired in series with the LEDs. It should have a rating between 470 Ohms and 2.2 kOhms. Running the LEDs without this resistor will lead to their immediate destruction! Unlike lightbulbs, LEDs are polarity-sensitive. The minus (cathode) end of the LED is connected to the function output, the plus (anode) end is connected to the blue (function common) wire.



Please do not forget to switch the respective function output to LED mode. This will ensure a prototypical presentation of all light effects. Please refer to chapter 12.3. for more details.

Installing the decoder

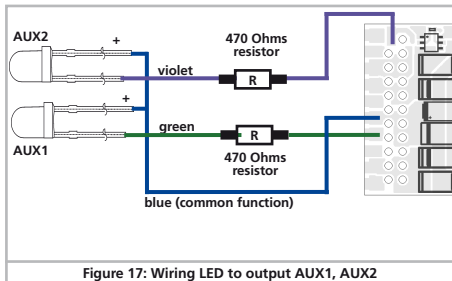

Figure 17: Wiring LED to output AUX1, AUX2

6.10.3. Connecting the Light Outputs, AUX1 and AUX2

This procedure depends on the wiring of the lights and auxiliary functions in the locomotive:

- The lamps / function outputs are insulated from the common pole (ground) (i.e.: the locomotive chassis); therefore they are potential free. Fig. 11 shows the correct wiring for the outputs AUX1 and AUX2. The functions of the locomotive must be potential-free, in other words there may not be any other connection to the function besides the wires from the decoder. The voltage at these outputs is about 1.5V lower than the track voltage. The blue wire is the „plus-pole“; the function output the „minus-pole“.



If LEDs are installed (also refer to Fig. 11), then a resistor must be wired in series with the LEDs. It should have a rating of between 470 Ohms and 2.2 kOhms. Running the LEDs without this resistor will lead to their destruction!

- The lamps / function outputs are wired (together) against the chassis of the locomotive (as in most locomotives by Märklin® as well as in most older locomotives by Fleischmann® and ROCO®).

The wiring is simpler but the available voltage is about half. This type of connection is not suitable for multi-protocol operation. Both M4 and Motorola® packets are asymmetrical. Therefore, the function outputs do not have continuous power. This leads to a rhythmic flicker of the headlights (pulsing) that becomes particularly obvious with LEDs.

Furthermore, the headlights will only work in one direction in analogue DC mode. Whether it will be the forward lights or the backup lights depends on which way you have placed your locomotive on the track.

- Solder the backup lights to the yellow wire, the headlights to the white one.

If your locomotive is wired according to option b), then it is ready for use. Otherwise, you must connect the remaining wires of all bulbs and functions together to the blue wire. This pole may not have any connection to the chassis! It is possible to use both options in the same locomotive.



6.10.4. Using AUX3 and AUX4

6.10.4.1. LokSound with 21MTC Interface

LokSound decoders with 21MTC interface have two additional outputs besides the 4 standard outputs, namely AUX3 and AUX4. Since they are pure „logic-outputs“, it is not possible to connect any external loads directly. External power transistors are required. Connect AUX3 and AUX4 via the interface; there are no wire leads. In terms of their functionality, AUX3 and AUX4 are equal to the other outputs. ESU offers an appropriate adapter board (art. no. 51968) with transistors.

6.10.4.2. LokSound V4.0 M4 - LokSound with PluX interface

The outputs AUX3 and AUX4 of the LokSound V4.0 M4 respectively LokSound decoders with PluX interface have an amplified end stage. Therefore one may connect loads directly. There are two solder pads at the back of the decoder for soldering stranded wires.

6.10.5. AUX5 through to AUX 10

LokSound XL V4.0 decoders have additional function outputs that may be used as desired.

Installing the decoder

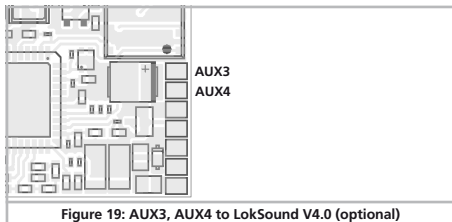

Figure 19: AUX3, AUX4 to LokSound V4.0 (optional)

6.10.5.1. Servo outputs

AUX7 through to AUX10 may be used for “normal” loads but are also capable to drive RC servos. All commercially available RC servos with a positive pulse are suitable. Please observe the correct polarity when connecting the servos. Prior to controlling the servos you must set the outputs to “Servo”. Please refer to chapter 12.3.7. for more information.

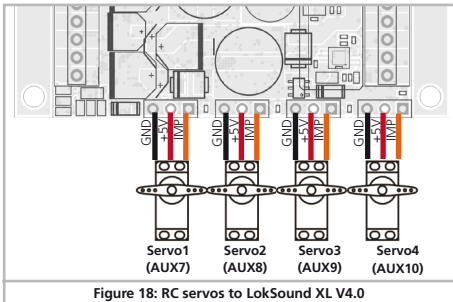

Figure 18: RC servos to LokSound XL V4.0

6.10.6. Suitable Smoke Generators

Unfortunately, it is not an easy task to find the right smoke generator for each locomotive. The amount of smoke generated depends on the following factors:

- Track voltage
The track voltage varies depending on the command station. Therefore, it is possible that a locomotive generates smoke when driven by one digital system but does not generate any smoke with another system. Even 1V variation makes a big difference.
- Type and tolerance of the Seuthe smoke generator and the smoke distillate
Seuthe smoke generators have considerable production tolerances. Therefore, it is possible that one unit works perfectly well while another does not. Type of distillate and filling level have an influence as well.
- Setting the decoder output
For correct smoking action you should set the AUX output to „Dimmer“ as well as full „Brightness.“ More info in chapter 12.
- Connecting the smoke generator
Most smoke generators are wired against the chassis (ground). Therefore the smoke generator only receives current in every second half cycle. How much power gets to the smoke generator depends on your command station and the digital protocol. Generally, Seuthe type 11 is recommended, but it does not get enough power and therefore does not smoke satisfactorily.

There are two options on how to solve this problem:

Solution 1: Using the Seuthe No. 10. This type is intended for analogue operation and draws a relatively high current. Subject to its tolerance levels, it may trigger the overload protection of the decoder. In this case, you must wire a relay (ESU No. 51963) into the circuit or you slightly reduce the „Brightness“ of the output.

Solution 2: Using the Seuthe No. 11. Do not wire it against the chassis (ground) but rather use the blue wire for the second pole („U+“). This prevents the asymmetric track signal from interfering

Installing the decoder

with the smoke generator. It represents the best solution but is sometimes a bit difficult in terms of wiring.

6.10.7. Connecting a wheel sensor

If you want to synchronise the steam exhaust chuff using a sensor, you have a little work to do. LokSound V4.0 decoders (unfortunately not the LokSound micro V4.0) support several types of sensors: Hall sensors, reed switches and mechanical wipers. The most accurate result you will get when using a hall sensor IC in combination with (up to) four magnets.



If you want to use an external sensor, you need to configure the LokSound in such a way that it will use the sensor input. The LokSound is setup ex works to use the computed exhaust chuff.

Set CV 57 to 0 in order to tell the LokSound to use the external sensor.

Using CV 58, you can define how many sensor pulses the decoder has to receive before it generates a steam chuff. Set CV 58 = 1 to get a triggered chuff on each pulse the decoder receives from the sensor. Based on the type of sensor IC you use, this may result in double the amount of steam chuffs you want to have. In this case, set CV 58 = 2. For values of 2 and more, every trigger pulse the decoder counts will result in one steam chuff. This is useful for geared locomotives.

6.10.7.1. HALL Sensor IC

A Hall sensor is an electronic circuit that responds to an alternating magnetic field similar to a reed switch. Hall sensors are easier to adjust since the distance between sensor and magnet is not critical. A commonly used hall sensor, that can be purchased via mail order is the TLE4905 by Siemens / Infineon. There are also many compatible devices on the market. The terminals have to be wired to the LokSound as shown in figure 12. Place four miniature magnets on the inner side of the driving wheel in such a way that the magnet will trigger the HALL IC each time it will pass the sensor IC.

For 3-cylinder locomotives, you may even need 6 or 8 magnets, depending on the cylinder configuration.

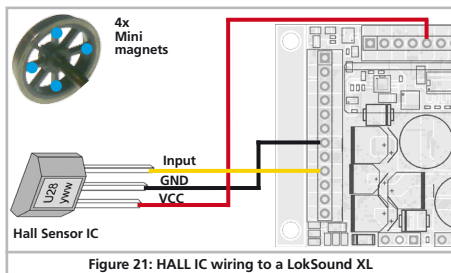
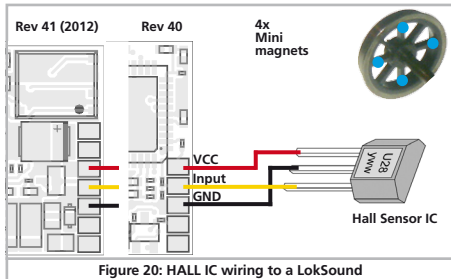

6.10.7.2. Reed switch sensor

If you have trouble obtaining a hall sensor IC, you may also use a subminiature reed switch. They are connected to the decoder with two pins only.

Installing the decoder

However, their sensitivity is not as good as hall IC sensors and stronger magnets may be needed in order to trigger these reed switches correctly. Furthermore the position of the reed switches needs to be considered.

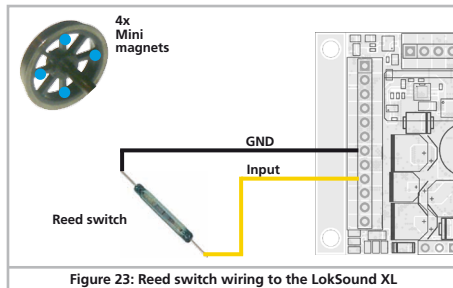
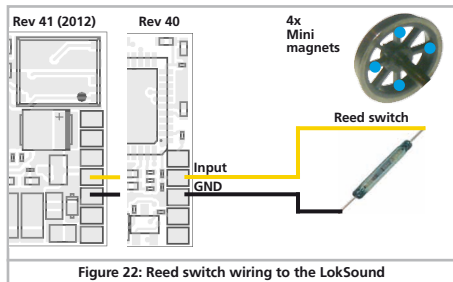

6.10.7.3. Additional sensor inputs

For triggering sound effects the LokSound XL V4.0 has two additional sensor inputs SENSOR1 and SENSOR2 (refer to Fig. 7). The inputs are suitable for reed contacts or HALL sensors. The wiring is shown in chapter 6.10.6.1. respectively in chapter 6.10.6.2.

6.11. Connecting Capacitors

On many older layouts, current pick up of locomotives is not very reliable. Therefore, power interruptions may cause a stop or jerky movement when the locomotive travels over turnouts at low speeds. This can be overcome with buffer capacitors (100 mF / 25V or higher show the desired results). If desired you may connect them to the LokSound V4.0, LokSound V4.0 M4 or LokSound micro V4.0.

 Soldering wires onto a decoder requires quality soldering equipment and experience. Our warranty does not cover damage caused by inappropriate soldering. Consider carefully if you really need that capacitor.

6.11.1. LokSound H0, LokSound micro decoders

You can connect two larger capacitors as per the circuit in the upper half of figure 14.

The capacitor is charged via a resistor (100 Ohms) thus preventing the digital system from interpreting the charging current as short circuit at the time of switch-on. The diode makes sure that the energy of the capacitor is fully available when required.

 However, you may not run this locomotive on AC layouts anymore. Risk of destruction!

 Disconnect / remove the capacitor prior to programming with the ESU LokProgrammer!

Installing the decoder

6.11.2. "PowerPack"

You can solder a powerful energy buffer to all LokSound V4.0 H0 / micro decoders. In the lower half of figure 24 we show you how to do it. This „PowerPack“ allows your locomotive to keep running for 2 seconds without power.

- The PowerPack only operates in digital mode. It automatically turns off on analogue layouts.
- It may take up to two minutes to fully charge the capacitor („Gold-Cap“). Therefore, the time bridged with the energy buffer depends on the current draw of your locomotive and the charge-up time.
- Further information about how to use the PowerPack module is to be found in the "PowerPack module" manual.

The LokSound XL V4.0 has an integral PowerPack matching the higher current needed by models of the larger gauges. Additional buffering with capacitors or further PowerPacks is neither intended nor necessary.



The time to be bridged with the PowerPack can be set in CV 113. Find more details in chapter 10.9.

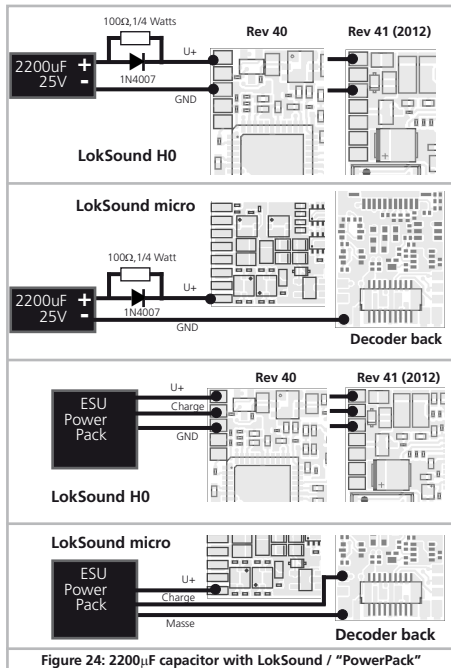

Figure 24: 2200µF capacitor with LokSound / "PowerPack"

7. Initial Operation

7.1. Factory Default Values

The address is set to 03 with 14 speed steps.

LokSound V4.0

F1 switches the sound on/off

F2 switches the whistle/signal horn

The remaining function keys are used differently depending on the prototype. On our website you will find an appropriate function key assignment for every sound.

- Does the locomotive move in both directions?
- Does the indicated direction of travel correspond with the actual one? If not, are the motor leads swapped or is the 8-pin plug inserted the wrong way round?
- Switch on the lights: do they work properly? If you have installed a LokSound with an 8-pin plug, check if the plug sits in the socket correctly.

7.2. Digital Operating Modes

In the following chapters, we describe the operation of the LokSound with different digital systems.



Since not every LokSound supports all digital systems, we state which chapter is applicable for which type.

7.2.1. DCC operation mode

LokSound V4.0

LokSound micro V4.0

LokSound XL V4.0

LokSound V4.0 M4



Remove any capacitors that are wired into the track feeders (e.g. ROCO® feeder track). This could impair the functionality of the decoder.

The LokSound works with any DCC system. Unfortunately, the DCC protocol also brings some difficulties into the game. One of them occurs so often that we deal with it right away.

7.2.1.1. DCC Speed Steps („flashing lights“)

„Lights do not work“ with DCC systems: DCC locomotives run with 14, 28, or 128 speed steps. The decoder offers all of the three options and needs to „know“ with which option the command station operates the decoder. The command station must be able to operate with this mode and must be set accordingly. If this is not the case, the following problems may occur:

- You cannot switch the lights with F0 at all.
- The lights keep switching on and off dependent on the speed step. On and Off again, and On again, and Off again etc.

In this case, make sure that the speed step settings of decoder and command station are the same.

7.2.1.2. Auto-detection of DCC Speed Steps

LokSound decoders implement auto-detection to avoid the above problem. We have tested this with the following systems:

- ESU ECoS®
- Bachmann E-Z-Command® Dynamis®
- ROCO® Lokmaus2 and Lokmaus3
- Uhlenbrock® Intellibox
- Lenz® Digital plus V2.3

- ZIMO® MX1



When operating with Lenz® digital plus V3.0 the auto-detect feature does not work at 14 speed steps. Select 28 / 128 speed steps instead.

The LokSound tries to establish the speed step setting every time it receives power (i.e.: after switching on the power on your layout or the track sector where your locomotive is located) and the lights are switched on. This process requires that you switch on the lights and turn the throttle until the lights light up continuously.

Should you change the speed step setting during operation then you must interrupt the power to the decoder for a short moment in order to activate the auto-detection.

This auto-detect feature can be turned off with bit 4 in CV 49 (also refer to the CV table in chapter 21.1). Then you have to set the correct speed step with bit 5 in CV 29.

7.2.2. Motorola® mode

LokSound V4.0

LokSound micro V4.0

LokSound XL V4.0

LokSound V4.0 M4

The LokSound works with all Märklin® devices and compatible systems that are in the market until now. The functions F1 to F4 can only be activated with the so-called „new Motorola® format.“ In order to activate this you must set the DIP-switch 2 on your 6021 to the upper position („On“).

LokSound decoders support two special features in Motorola® mode:

7.2.2.1. 28 Speed Steps

While the original Motorola® system used by the following central units, namely Märklin® central unit 6021, Delta® and Mobile Station®, only supports 14 speed steps, the LokSound decoder can also handle the 28-speed step mode. In conjunction with suitable command stations (e.g.: ESU ECoS, in „Motorola® 28“ mode) this leads to smoother control of your locomotives. No changes are required on the decoder.

7.2.2.2. Extended Motorola® Address Range

While the original Motorola® format only knows the addresses from 01 to 80, the LokSound offers the following range of addresses:

LokSound V4.0

01 - 255

Chapter 9 explains how to set the address. There it is described how with the aid of the second, third and fourth address (consecutive addresses) more than four functions can be controlled.

7.2.3. Selectrix® mode

LokSound V4.0

LokSound micro V4.0

LokSound XL V4.0

LokSound V4.0 M4

You may operate the LokSound with any Selectrix® compatible command station with access to the functions „lights“ and F1.

For programming any parameters, you must use the DCC programming mode. It is not possible to program it with a „pure“ Selectrix® system. Any changes programmed in DCC are also valid for operation with Selectrix® command stations.

As soon as a decoder receives commands in Motorola® or DCC format (whenever it receives a signal packet with information addressed to it), the Selectrix® receiver switches off automatically. This allows trouble-free mixed operation with Selectrix® / DCC / Motorola®. The Selectrix® receiver turns on again as soon as the decoder detects a power interruption.

Initial Operation

7.2.4. M4 mode

		LokSound XL V4.0
LokSound V4.0 M4		

The LokPilot M4 is recognised and embedded into the system automatically by the Märklin® systems devices Central Station®, Central Station® 2 and Mobile Station® immediately after placing the locomotive onto the track. This process runs automatically and does not require any specific decoder settings.

As soon as the decoder receives a valid mfx® data packet (whenever the decoder recognizes that it is run by an mfx® capable central unit) it will ignore Motorola®, Selectrix® as well as DCC data packets.

Only after interrupting power to the decoder briefly or if it does not receive any mfx® data packets for about 4 seconds will it accept other data packets again. The decoder prioritises its response to incoming data packages:

- Top priority is assigned to DCC with RailComPlus®. Therefore the decoder will always register with RailComPlus and DCC to an ESU ECoS command station, even when M4 is active.
- If RailComPlus® is not available the second priority is M4. The decoder will register with M4 to Märklin Central Station® command stations.
- “Standard” DCC is at the same level as Motorola®.
- Selectrix® has the lowest priority.



Data protocols not required can be turned off. How this is done you find out in chapter 9.5.

7.3. Analogue Mode

All LokSound decoders are set ex factory to operate in analogue mode as well.



Please take note of the remarks in chapter 10.4 if the decoder should move repeatedly from analogue into digital sectors and back.

7.3.1. Analogue DC operation

LokSound V4.0	LokSound micro V4.0	LokSound XL V4.0
LokSound V4.0 M4		

LokSound decoders work on conventional DC layouts. From the factory, load compensation is active. This provides smooth control of your locomotives even at low speeds (in DC mode as well). Since load compensation requires about 3 – 4 Volts as „base voltage“ you must turn the throttle further than normal (=locomotives without decoder) before the locomotive starts moving.

7.3.2. Analogue AC Operation

LokSound V4.0		LokSound XL V4.0
LokSound V4.0 M4		



Other LokSound decoders than the ones mentioned above are not suitable for analogue AC mode. AC will definitely lead to the destruction of the decoder!

Where intended, LokSound decoders support operation with AC transformers. Therefore, the LokSound decoder can simply replace the old directional relay. Load compensation is active (similar to DC mode) and provides smooth control and slow-speed-performance you have never seen before. The LokSound V4.0 recognised the pulse for changing direction as usual. Just wait until the locomotive has stopped prior to changing direction.



Never issue the „Change of Direction“ command to a moving locomotive! This could lead to damaged gears!



We cannot recommend the use of the old (blue) Märklin® transformers that were originally designed for 220 Volt. Depending on their age and their tolerance range, the pulse for changing direction could be too high in case of increased mains voltage and therefore destroy the LokSound decoder.

Do yourself and your locomotives a favour and purchase a suitable Märklin® transformer No. 6647 – your locomotives and decoders will thank you with longer product life!

8. Decoder Settings (Programming)

Chapter 8 covers setting various parameters of the LokSound decoder. Should you not be familiar with the handling of CVs please take the time to read these occasionally quite complex instructions.

After an introduction into the world of parameters in chapter 8.1, we explain in the following section 8.2 how to change various parameters in DCC mode and with Märklin® central units.

The chapters 9 to 16 explain which parameters have what kind of influence on the behaviour of the LokSound decoder.

8.1. Adjustable Properties of Decoders

The hardware determines some features such as the number of function outputs as well as the maximum permitted current of the motor output and therefore they are not programmable. Nevertheless, there are plenty of possibilities to influence the behaviour of the LokSound decoder by adjusting software-governed properties.

There is at least one memory space within the decoder reserved for each adjustable parameter where numbers or letters can be stored.

You could visualise the storage spaces as index cards in a large file box. In order to enable you to find the right card again, they all have numbers and / or names outlining the properties of this particular card such as „locomotive address“ or „maximum speed.“

Then imagine that you can write information onto these cards. Adjusting the settings means nothing else but erasing one entry and replacing it with another. Moreover, you could do that at any time. However, you cannot write onto every card: some bits of information like the manufacturer's code are firmly encoded.

Thus, you can determine the content of the storage spaces in the decoder even during operation and of course, the decoder will follow the instructions. Via the procedure known as „Programming,“ you can enter the desired data into the storage spaces.

8.1.1. M4 Configuration Range

		LokSound XL V4.0
LokSound V4.0 M4		

The NMRA CV concept as described above has some disadvantages: On the one hand dealing with „collection CVs“ such as CV 29 with its binary format is complicated while on the other hand you can only enter one value (!). How could one possibly store locomotive names with this method?

Furthermore, it is not possible for the command station to find out, which CVs a decoder supports. The NMRA has simply „forgotten“ to define a mechanism for providing feedback from the decoder to the command station regarding the supported CVs.

With the introduction of the mfx® system the user does not have to deal with CVs, values and the binary system. The command station should rather request the decoder to provide this kind of information and then enable the user to enter any values in an easy way on the graphic interface.

For instance, you do not have to enter the value 15 in CV 3 on an mfx® capable command station but rather set the acceleration time to 10 seconds. Thanks to M4 you do not have to remember that CV 3 contains the value for the acceleration time and that the value 15 is equivalent to about 10 seconds. This kind of complex technology is hidden in the mfx® command station.

Therefore the mfx® system does not cater for a direct method of influencing the memory spaces, the so-called mfx® configuration area of the decoder. Generally, M4 only permits access via the command station.

This method has only one drawback. How can the owners of other command stations that are not mfx® capable access the configuration area? This is facilitated by means of a register concept that is somewhat similar to the NMRA DCC CVs. Unfortunately this does not provide access to all characteristics of the M4 decoder. Furthermore mfx® was not developed further as intended originally and basically remains at the status of 2004.

Since ESU “educated” the Central Station® 60212 with the “Reloaded” Update and taught it to support DCC and when Märklin® followed with the current Central Station 2, the situation has been somewhat eased: All current mfx® command stations also support DCC and can program DCC decoders. Since all LokSound V4.0 decoders support DCC you now have the choice on how you wish to program your decoder:

- The Central Station® 60212 Reloaded and the Central Station 2 offer a graphic programming option for M4 decoders. However, it only recognises the “old” ESU LokSound V3.5 decoders and their possibilities as well as the similar and hardly changed Märklin decoders. The LokSound V4.0 M4 respectively the LokSound XL V4.0 can be programmed via this menu without any problems. Unfortunately some options are not available because the command station “does not know them”.
- You may access all options via DCC programming. If you own an ESU ECoS we recommend this kind of programming. This command station also provides a suitable profile for this decoder.

8.1.2. M4, the mfx® compatible protocol by ESU

Since the mfx® data protocol was introduced, it has been protected by Märklin® as a trade mark. This is why ESU decided in January 2009 to use the name “M4” for all their decoders. M4 is technically 100% compatible with mfx®.

All ESU decoders and command stations which are M4 compatible can be easily combined with the corresponding Märklin®-mfx® products. We would like to apologise for this inevitable change of names due to reasons of trademark.

8.1.3. Configuration Variables (CVs)

LokSound V4.0

LokSound micro V4.0

LokSound XL V4.0

LokSound V4.0 M4

LokSound decoders follow the CV concept developed in the US. CV stands for „Configuration Variable“ and indicates that the storage cells described above are not only variable but they also determine the behaviour of the decoder.

8.1.3.1. Standardisation in the NMRA

The NMRA (National Model Railroad Association) has defined which CVs determine certain parameters of a decoder. The DCC standard allocates fixed numbers for certain CVs (adherence is obligatory). This greatly simplifies things for the user since decoders of most manufacturers comply with this standard and therefore dealing with CVs requires the same process with the same CV-numbers regardless of the manufacturer.

The DCC concept permits to enter numbers ranging from 0 to 255 into CVs. Each CV carries only one number.



While the position number is predetermined, the range of values may vary. Not all CVs must accept values ranging from 0 to 255.

The permitted values for LokSound decoders are listed in the table in chapter 20.1. showing all available CVs.

8.1.3.2. Bits and Bytes

Most CVs contain numbers: CV 1 for instance contains the locomotive address. This can be any number between 1 and 127. While most CVs expect numbers to be entered, some others are rather like a „collection point“ of various „switches“, that administer different functions in one CV (mainly „on“ or „off“): CVs 29 and 49 are good examples: you must calculate the value for these CVs yourself. The value depends on which settings you want to program:

Have a look at the explanations for CV 29 in the table in chapter 20.1.: firstly, decide which options should be active. The column „Value“ has two numbers for each option. If the option is switched off, the value is 0. Otherwise, it is a number between 1 and 128. Add all the values for the respective options to arrive at the correct value for this CV.

Example: Let us assume you want to run trains with the ECoS in DCC mode with 128 speed steps. Analogue detection should be active (because you also want to drive your locomotive in analogue mode). All other options are not active.

Therefore you must write the value 6 in CV 29 (0 + 2 + 4 + 0 = 6).

8.2. Programming with popular Digital Systems

As already explained it is not possible to program every type of LokSound with every command station in the market. This chapter explains which options are available.

8.2.1. Programming with DCC Systems

LokSound V4.0

LokSound micro V4.0

LokSound XL V4.0

LokSound V4.0 M4

LokSound decoders support all NMRA programming modes as there are the programming track modes (Direct Mode, Register Mode, Paged Mode) and the mode for the main („POM“, „Programming on the Main“).

Programming on the Main enables you to program your decoders comfortably without having to remove the locomotive from the layout. In this case, the command station talks directly to the decoder by using its locomotive address, for instance: „Locomotive number 50, write the value 7 into CV 31“. Thus knowing the locomotive address is a precondition. Unfortunately, you cannot read CV values.



However, with RailCom® you can read CV values on the main. More on this topic in chapter 16.

Assuming you have a suitable DCC system you can read CV values on the programming track. You can also reprogram the locomoti-

ve address without knowing the old address since the command station simply transmits the command „Write value 7 in CV 3!“. Each decoder receiving this command will execute it.



ESU counts the bits from 0 to 7 as laid out in the standards while others (e.g.: Lenz®) count the bits from 1 to 8.

8.2.2. Programming with the ESU ECoS

LokSound V4.0

LokSound micro V4.0

LokSound XL V4.0

LokSound V4.0 M4

Owners of an ESU ECoS can comfortably program LokSound decoders. ECoS has a library of „Decoder Profiles“ that help you to program decoders with the graphic display. All CVs are stored in the decoder profile thus enabling the ECoS to read them and to display them on the screen. Chapter 16.5. of the ECoS manual provides more information on this topic.



Please make sure that you always use the latest ECoS firmware version. Whenever we expand the range of the LokSound family, only an update will add the required decoder profile.

8.2.3. Programming with Märklin® 6021

LokSound V4.0

LokSound micro V4.0

LokSound XL V4.0

LokSound V4.0 M4

The Märklin® central unit 6021 works differently: Since it does not comply with the NMRA DCC standards, LokSound decoders start a special, obligatory programming procedure. Reading of values is not permitted.

There are two modes:

In the short mode, parameters with a number below 80 can be set provided the desired value is also lower than 80.

In the long mode, all parameters with values from 0 to 255 are adjustable. Since the display of the 6020 /6021 is limited to two-digit numbers, values must be split and entered in two separate steps.

8.2.3.1. Changing to the Programming Mode

Enter the programming mode with the 6020/6021:

The throttle must be set to „0“. No other locomotives may be on the layout. Watch out for flashing signals of the locomotive!

- Press the „Stop“ and „Go“ buttons of the 6021 simultaneously until a reset has been triggered (alternately pull the mains plug of the transformer). Press the „Stop“ button in order to switch off the track voltage. Enter the current decoder address. If you do not know the current address, simply enter „80“.

- Activate the change-of-direction button (turn the throttle knob to the left beyond the arrester until you hear a click sound), hold it in this position and then press the „Go“ button.



Please bear in mind that the 6020/6021 only permits you to enter values from 1 to 80. The value 0 is missing. Always enter „80“ instead of „0“.

8.2.3.2. Short Mode

The decoder is in the short mode (the headlights flash periodically in brief intervals).

- Now enter the number of the CV that you want to adjust e.g.: „01“. Always enter this number with two digits.
- For confirmation activate the change-of-direction routine (now the lights flash twice very quickly).
- Now enter the new value for the desired CV, e.g.: 15 (two digits).
- For confirmation activate the change-of-direction routine (now the lights light up for about one second).
- Then you can enter other CVs as desired.
- Selecting „80“ allows you to exit the programming mode. Alternately you can switch off the track voltage and then on again (press the „Stop“ button on the 6021, then the „Go“ button).

8.2.3.3. Long Mode

You access the long mode by entering the value 07 in CV 07 while in the short mode. The decoder confirms the change to the long mode by slowly flashing lights.

- Enter the hundred-digit and the ten-digit (decade) of the CV that you want to change. Example: If you want to adjust CV 124, you enter „12“.
- For confirmation activate the change-of-direction routine (now the lights flash periodically: long – short – long – short - etc.)
- Now enter the unit of the CV („04“ in this example).
- ⚠ For confirmation activate the change-of-direction routine. Now the decoder expects the entry of the CV value. The lights flash periodically: long – short – short).
- Now enter the hundred-digit and the ten-digit (decade) of the new CV value (as a two-digit number). Example: You want to write the value 135. Therefore, you enter „13“.
- For confirmation activate the change-of-direction routine. Now the lights flash periodically: long – short – short – short).
- Now enter the unit of the new CV value as a two-digit number („05“ in this example).
- For confirmation activate the change-of-direction routine (now the lights light up for about one second).
- Now you can adjust more CVs in long mode.
- Exit the long mode by switching off the track voltage and then on again (press the „Stop“ button on the 6021, then the „Go“ button).

8.2.4. Programming with the Märklin® Mobile Station®

LokSound V4.0

LokSound micro V4.0

LokSound XL V4.0

LokSound V4.0 M4



With the Mobile Station®, you can also adjust some of the CVs. Use the Register Programming Menu to facilitate this.

As with the 6021, you can only enter values between 1 and 80. The possible CV values are also limited to that range from 1 to 80.

You will find the programming menu in the locomotive menu of the Mobile Station®. It is only available for certain locomotives. Of course, this works only for a programmable locomotive.

Proceed as follows:

- Enter a new locomotive in the database. How you do this is explained in the manual for the Mobile Station®.
- Select locomotive 36330. The locomotive Ex 3/3 is shown as active on the display.
- By pressing the „MENU / ESC“ button you can now change any of the settings such as name, address, etc. in the heading „CHANGE LOCOMOTIVE“. The last function shown is „Register Programming“ (REG). Select this for writing CVs.
- Then select the CV (called „REG“ on the Mobile Station®) and then the desired value and confirm by pressing the change-of-direction button.
- The Mobile Station® will program the new value into the decoder.



Please remove all locomotives which should not be programmed!

8.2.5. Programming with the Märklin® Central Station

LokSound V4.0

LokSound micro V4.0

LokSound XL V4.0

LokSound V4.0 M4

With the Central Station® until software version 2.04, you can program the CVs 1 to 80 via the Motorola® programming menu. Unfortunately, you can only enter values between 1 and 80. Find more information regarding this programming mode in chapter 8 of the manual of the Central Station®.

Owners of a Central Station “Reloaded” or a Central Station 2 can program LokSound decoders in DCC mode without any problems. With the CS1 “Reloaded” please proceed as described in the manual in chapter 18 (“Decoder programming”).

When using a Central Station 2, DCC programming is somewhat trickier.

- Establish a new locomotive manually. This must be done even if the decoder registers itself via mfx®. The locomotive address is not important in this context.
- Call up the new “Dummy” locomotive with a throttle.
- Open the menu “Edit locomotive” and select type “DCC”.
- Open the function “Edit locomotive”.
- Now enter all CVs you wish to configure in the list. Only then the command station will read out the values and save any changes.

LokSound XL V4.0

LokSound V4.0 M4

The M4 capable decoders can be programmed directly via the decoder menu with all mfx® compatible command stations. However, not all decoder options may be available in this mode. This compromise is necessary in order to serve all mfx® command stations on the market.

8.2.6. Programming with the ESU LokProgrammer

LokSound V4.0

LokSound micro V4.0

LokSound XL V4.0

LokSound V4.0 M4

The LokProgrammer 53451 offers the easiest and most comfortable way of setting the CVs of LokSound decoders: simply by a few mouse clicks on an MS-Windows® computer. The computer saves you to look for the various CV numbers and values. More information is contained in the manual for the LokProgrammer.

You can access all properties of ESU decoders with the LokProgrammer. Since this works independently from the data format it also works for mfx® decoders.

Please use the software version from V4.3.0 onwards for the LokSound V4.0 decoder. The software is available for download on our website!

8.2.7. Programming with the ROCO® Multimaus

LokSound V4.0

LokSound micro V4.0

LokSound XL V4.0

LokSound V4.0 M4



Due to a severe firmware error the current LokSound V4.0 decoder cannot be programmed with the Multimaus - firmware 1.00. In this case you must return your Multimaus to your dealer or directly to the ROCO® service for an update to version 1.02 or a newer.

Unfortunately the ROCO® Multimaus® is not able to program any CVs via number 255 due to an error in the current (State: Dec. 2010) firmware version 1.02. To make, however, a proper programming procedure possible, we implemented an assistance tool. This helps to write the number of the CVs desired temporarily into two assisting CVs (so-called address registers), since the usual CVs cannot be reached.

Afterwards the value of the CV desired will be programmed into another assisting CV (so-called value register). When the value register is written, the content will be copied to the actual desired

position and the assisting CV will be set back.

Consequently, 3 CVs have to be programmed to write one CV.

These 3 CVs mean the following:

CV	Name	Description	Value range
96	Address offset	Saves the CV number that should be actually programmed in hundreds.	0 – 9
97	Address	Saves the CV number that should be actually programmed in units and tens.	0-99
99	Value	Saves the value of the CV that should be actually programmed.	0-255

Example: You wish to programm CV 317 with value 120.

Proceed as follows:

- Programm the value of the CV number in hundreds in CV 96. In this example: CV 96 = 3.
- Programm the value of the CV number in units and tens in CV 97. In our example: CV 97 = 17.
- Programm the desired value in CV 99. In our example: CV 99 = 120.

As soon as you have programmed CV 99, the value of CV 99 will be transferred into CV 317. Is the programming finished, CVs 96, 97 and 99 will be set back automatically.

8.2.8. Programming with the ROCO® LokMaus II

LokSound V4.0

LokSound micro V4.0

LokSound XL V4.0

LokSound V4.0 M4

The ROCO® LokMaus II is generally one of the most successful DCC command stations. However, as an affordable system designed for beginners it only allows the writing of two-digit CV numbers as well as CV values.

Similarly as with the MultiMaus® the problem can be solved via an assistance procedure. This helps to program the number of the CVs desired temporarily into two assisting CVs (so-called address registers) instead of programming the actual CV. Afterwards the value desired will be separated into two parts and programmed into two further assisting CVs (so-called value registers). When the last value register is written, the content will be copied to the respective desired position and all assisting CVs will be set back.

Consequently, 4 CVs have to be programmed to write one CV.

These 4 CVs mean the following:

CV	Name	Description	Value range
96	Address offset	Saves the CV number that should be actually programmed in hundreds.	0 – 9
97	Address	Saves the CV number that should be actually programmed in units and tens.	0-99
98	Value offset	Saves the value that should be actually programmed into hundreds.	0-9
99	Value	Saves the value of the CV that should be actually programmed in units and tens.	0-99

Example: You wish to program CV 317 with value 120.

Proceed as follows:

- Programm the value of the CV number in hundreds in CV 96. In this example: CV 96 = 3
- Programm the value of the CV number in units and tens in CV 97. In our example: CV 97 = 17
- Programm the CV value in hundreds in CV 98. In our example: CV 98 = 1
- Programm the CV value in units and tens in CV 99. In our example: CV 99 = 20

As soon as you have programmed CV 99, the value of CV 99 will be transferred into CV 317. Is the programming finished, CVs 96, 97, 98 and 99 will be set back automatically.

9. Address Settings

Each LokSound decoder requires a definite address to be addressable for the central unit. Depending on the type of decoder and the digital system, there are several possibilities how to allocate addresses.

9.1. Short Addresses in DCC Mode

LokSound V4.0

LokSound micro V4.0

LokSound XL V4.0

LokSound V4.0 M4

Normally you would control LokSound decoders with the short address that is stored in CV 1. In DCC mode, the permitted values range from 1 to 127. In order to enable the decoder to „listen“ to the short address you must delete bit 5 in CV 29.



Some digital systems (e.g. ROCO® Lokmaus II, Lenz® digital plus, Lenz® compact) only support the values 1 – 99 as short address.

9.2. Long Addresses in DCC Mode

LokSound V4.0

LokSound micro V4.0

LokSound XL V4.0

LokSound V4.0 M4

You can operate LokSound decoders also with long addresses (4-digit addresses). The supported values range from 128 – 10239. The long address is stored in the CVs 17 and 18. You must activate the long address by setting bit 5 in CV 29.



Bit 5 in CV 29 switches between short and long address. The decoder can only respond to one address at a time.

If you want to use your LokSound with the long address it is practical to program this address directly with your digital system: most modern digital systems (e.g. ESU ECoS, Bachmann E-Z Command® Dynamis®) have a menu for programming long addresses. The command station not only programs CV 29 correctly but also assures the correct storage of the values for the long address in CV 17 and 18.

Adresseinstellungen

If you want to enter the long address manually in CV 17 and 18 please refer to chapter 22.1.

9.3. Motorola® Address

You can also operate many LokSound decoders with the Motorola® format. The address for this operating mode is stored in CV 1.

LokSound V4.0

LokSound micro V4.0

LokSound XL V4.0

LokSound V4.0 M4

This address is identical to the short address in DCC mode as described in chapter 9.1. The LokSound decoder responds both to commands in DCC and in Motorola® mode at the same time. The permitted values are listed in chapter 7.2.2.2.



Märklin® digital devices (6020, 6021, Delta®) can only work with addresses from 1 to 80. Should you have entered a higher value in CV 1 you will not be able to drive this locomotive with these central units.

9.3.1. Consecutive addresses for more functions

The extended Motorola®-Format covered only the lighting function (F0) and the auxiliary function F1 to F4. Of course, this is far too few for the many functions of the LokSound V4.0.

Therefore one can assign up to three additional addresses (4 addresses in total). The so called consecutive addresses follow immediately after the actual address stored in CV 1 and serve to trigger functions. Motor control is solely accomplished via the base address in CV 1.

Example: You select the address 50 in CV 1 for a class 50 locomotive. You want to set 3 consecutive addresses. They are 51, 52 and 53. They will then switch the consecutive functions whenever you call up these addresses on your 6021:

Name	Address	Functions
Base address	50	F0, F1 – F4
Consecutive address 1	51 (50+1)	F5 – F8
Consecutive address 2	52 (50+2)	F9 – F12
Consecutive address 3	53 (50+3)	F13 – F16



Please make sure that no other vehicle is programmed to any of the consecutive addresses (in this example 51 to 53). Otherwise you will inadvertently run several vehicles at the same time! The consecutive addresses are activated with bits 3 and 7 in CV 49.

For reasons of compatibility they are not next to each other. The relationship is as follows:

Bit 7	Bit 3	Meaning	Value to be added to CV 49
0	0	No consecutive address	0
0	1	Consecutive address 1 active	8
1	0	Consecutive address 2 active	128
1	1	Consecutive address 3 active	136

First read out the value in CV 49 (default value: CV 49 = 1) and the value shown in column 4. If, for instance, you wish to activate 3 consecutive addresses then you must write the value $136 + 1 = 137$ into CV 49.



Consecutive addresses are only active in Motorola® mode.

9.4. Addresses in M4 mode

LokSound XL V4.0

LokSound V4.0 M4

Adapting the Driving Characteristics

Even in an mfx® compatible system addresses are needed for controlling locomotives. However, they are assigned automatically by the command station when the locomotive reports to it for the first time. The addresses can neither be programmed manually by the user nor can they be read out.

9.5. Turning off data protocols not needed

If you know for certain on which layouts your locomotives will be “travelling” you can turn off the data protocols not needed. This is useful if multi protocol command stations lead to problems. CV 47 is responsible.

CV 47 Bit	Protocol	Value
0	DCC protocol on DCC protocol off	1 0
1	M4 protocol on M4 protocol off	2 0
2	Motorola® protocol on Motorola® protocol off	4 0
3	Selectrix® protocol on Selectrix® protocol off	8 0

Ex works all protocols are active (CV 47 = 15). In order to establish the value of CV 47, simply add all values in column 3 and write them into CV 47.



For safety reasons the protocol used for writing into CV 47 cannot be turned off. If you use, for instance, an ESU ECOS and write CV 47 in DCC format then the DCC protocol will remain on. If you use a 6021 then, of course, the Motorola® protocol cannot be turned off.



Programming with the ESU LokProgrammer cannot be turned off either.

10. Adapting the Driving Characteristics

10.1. Acceleration and Deceleration

Acceleration and brake time can be set independently from each other. Therefore, you could for instance program a short acceleration and a much longer brake time.

The time for accelerating is adjusted in CV 3 while deceleration is set in CV 4. Permitted values are 0 (no delay) to 63.

The times set in these CVs work speed dependant. Therefore, the acceleration distance and the brake distance are longer at high speeds. In other words, the faster the locomotive moves, the longer is the distance until it stops.



For information on how to set a brake distance independently of the speed refer to chapter 10.6.

10.1.1. Switching Acceleration / Deceleration

LokSound decoders can deactivate acceleration and deceleration by the push of a button. This is particularly handy for shunting since your locomotive responds directly to the throttle.

The default setting for this function is function button F4.

10.1.2. Shunting Mode

The default setting for the shunting mode is F3. It reduces the speed to about 50%. Thus, you have smoother control of your locomotive in the lower speed ranges, which is important for shunting, particularly in the 14-speed-step mode.

10.2. Starting Voltage, Maximum and Medium Speed

LokSound V4.0

LokSound micro V4.0



LokSound decoders know internally 256 speed steps. They can be adapted to the characteristic of the locomotive and allocated to the actually available speed steps (14, 28, or 128).

The NMRA defined two options to facilitate this:

Adapting the Driving Characteristics

Motor characteristic via CV 2, 5, and 6 (Fig. 25): Enter the start voltage in CV 2 and the maximum speed in CV 5. CV 6 corresponds with the speed at a medium speed step. Thus, you can define a “kink” in the speed curve. This mode is active if bit 4 = 0 in CV 29.



The values of the start, mid and maximum speed are dependent on each other. Selecting a mid speed that is lower than the start speed or higher than the maximum speed could lead to some erratic driving performance. Therefore always adhere to the principle: start voltage < mid speed < maximum speed.



The M4 capable decoders do not implement the 3-point line as per the NMRA standards. Instead only the start voltage (CV 2) and the maximum speed (CV 5) are supported. You will find more info on this in chapter 10.3.

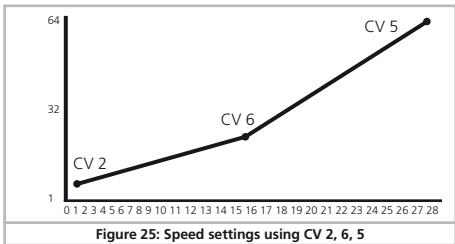

10.3. Speed Curve

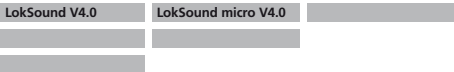

You may also define your own speed curve: simply enter the desired values in the CVs 67 to 94 (also refer to Fig. 16). The decoder will superimpose these 28 values onto the real speed steps. Thus, you can adapt the driving performance optimally to your locomotive. This mode is only active if bit 4 in CV 29 is set.

We recommend using the ESU LokProgrammer for easy and comfortable programming.



When this mode is active, the settings in CV 2, CV 5, and CV 6 have no influence.



LokSound V4.0 M4 and LokSound XL V4.0 implement the concept of the mfx® speed curve. That means that the speed curve is always active and cannot be turned off with CV 29 bit 4. CV 2 and CV 5 define a scale factor around which the points of the speed

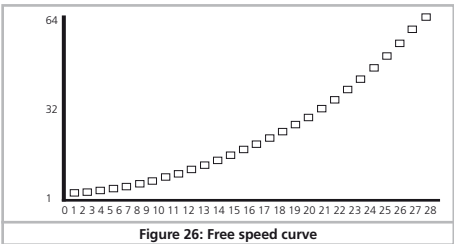

Adapting the Driving Characteristics

curve are scaled. This way it is far easier to adjust the maximum speed of a locomotive to an active speed curve.

Have a look at the speed curve in Fig. 26. The last entry (CV 94) is 255. This represents full speed. If you wish to reduce the maximum speed you only have to reduce the value of CV 5. The decoder computes (squeezes) the speed curve in such a way that the shape of the speed curve remains despite the lower maximum speed.

The same is true for the first entry. The speed curve will be raised and scaled subject to the value in CV 2.



The CVs 67 and 94 are permanently set to the values of 1 respectively 255 in this decoder.

10.4. Changing between Operating Modes

You may change from a digital to an analogue sector of your layout „on-the-fly“ at any time.

The locomotive behaves as follows:

10.4.1. Changing from Digital to Analogue DC

When the decoder enters the analogue DC sector, it monitors the polarity of the track voltage. If the polarity (and the resulting direction of travel as per NEM) matches the direction of travel in digital mode the locomotive will continue without stopping at the speed that corresponds to the analogue voltage.

If the polarity does not match than the behaviour depends on the settings in CV 27:

If the DC brake mode is active in CV 27 then the locomotive will slow down to a stop with the programmed deceleration, if not, then the locomotive will change the direction and back out of the analogue sector. Chapter 10.5 provides detailed info about brake sectors and the appropriate settings.

10.4.2. Changing from Digital to Analogue AC

If a locomotive travels into an analogue AC sector, it will continue onwards in the same direction at a speed corresponding to the analogue track voltage.



This mode is not available for the LokSound micro V4.0!

10.4.3. Changing from Analogue to Digital (directional bit)

When entering the digital sector the locomotive compares the current direction of movement with the digital signals arriving via the track: If the actual direction matches the one as per the digital signal, the locomotive continues onwards at a speed corresponding with the digital signals.

Does the direction not match the commands from the digital system, then the behaviour depends on the settings in the „directional bit“ (also refer to chapter 15.1. for more details):

If the directional bit has been set, then the decoder ignores the directional commands from the central unit, the locomotive continues in the same direction; only the speed will be adjusted according to the commands from the central unit. Therefore, the actual direction of movement does not match the direction as intended by the central unit for the time being; however, this changes once a change-of-direction-command is activated at the central unit.

If the directional bit has not been set, then the locomotive slows down and stops according to the programmed deceleration, changes its direction and returns to the conventional sector. What happens next is described in chapter 10.4.1 resp. 10.4.2.

10.4.4. Changing from Digital to Digital

LokSound V4.0	LokSound micro V4.0	LokSound XL V4.0
---------------	---------------------	------------------

LokSound V4.0 M4	
------------------	--

Travelling between sectors with different digital protocols, namely Motorola® and DCC is possible at any time. The LokSound decoder interprets each valid data package from the command station.

LokSound V4.0	LokSound micro V4.0	LokSound XL V4.0
---------------	---------------------	------------------

LokSound V4.0 M4	
------------------	--

Travelling from Selectrix® to DCC or Motorola® is only possible after a short power interruption (also refer to chapter 7.2.3).

LokSound V4.0 M4

LokSound XL V4.0

As mentioned in chapter 7.2.4 a change over from Motorola® or DCC to mfx® is possible at any time as soon as the decoder contains a valid mfx® packet. When changing from mfx® to Motorola® respectively to DCC (for instance, when a locomotive moves from a DCC controlled sector on the layout to one that is controlled by a 6021) the decoder accepts the Motorola® packets after about 4 seconds. During the first 4 seconds the locomotive will continue with the current speed and direction.

10.4.5. Changing modes with Analogue Mode turned off

LokSound V4.0

LokSound micro V4.0

LokSound XL V4.0

LokSound V4.0 M4

Perhaps you have disabled analogue mode on your decoder (bit 2 in CV 29 is deleted). When the locomotive moves from the digital sector into the analogue one, the locomotive will continue with the set speed and direction. However, you cannot issue any commands to that locomotive until it is back in a digital sector.

Under certain circumstances, the decoder interprets the analogue DC voltage as brake sector and slows down to a stop; please refer to chapter 10.5.

10.5. Brake Sectors

Brake sectors have the purpose to slow down the locomotive independently from the commands issued by the command station. Frequently, this function serves for stopping a train in front of a red signal. If a LokSound detects a brake command, it will slow down with the programmed deceleration and then stop. After this enforced stop, the locomotive will accelerate again as per the programmed values in CV 3.

Depending on the type of digital system, there are several options on how to influence the decoder so that it stops the train.

10.5.1. DC Brake Mode

LokSound V4.0

LokSound micro V4.0

LokSound XL V4.0

LokSound V4.0 M4

In order to activate the DC brake mode you must set bit 3 in CV 27. The LokSound decoder will start brake once it moves from a digital sector into a DC sector provided the brake mode is active and the polarity of the track voltage does NOT match the current direction of travel. The locomotive will stop taking into account the programmed deceleration.

10.5.2. Märklin® Brake Mode

LokSound V4.0

LokSound micro V4.0

LokSound XL V4.0

LokSound V4.0 M4

In principle, the Märklin® modules 72441 / 72442 apply a DC voltage to the track instead of the digital signals. Provided bit 3 and bit 4 in CV 27 is set, then LokSound decoders detect this voltage and will stop the train (CV 27 = Value 24).



The signal generated by these modules looks the same as DC from conventional DC-transformers. The LokSound could possibly misinterpret this and switch to the analogue mode instead of brake.

Adapting the Driving Characteristics



If you wish to control the LokSound decoder with DCC signals and keep your Märklin® brake sectors then you should switch off the DC analogue mode by deleting bit 1 in CV 50. The LokSound will stop as desired.

10.5.3. Selectrix® Diode Brake Sector

LokSound V4.0

LokSound micro V4.0

LokSound XL V4.0

LokSound V4.0 M4

LokSound decoders also detect the Selectrix®-diode brake sector and stop as desired.

10.5.4. Lenz® ABC Brake Mode

LokSound V4.0

LokSound micro V4.0

LokSound XL V4.0

LokSound V4.0 M4

As a new function the LokSound V4.0 decoder supports the ABC braking technique introduced by Lenz®. In order to use this function a group of anti-parallel diodes will be soldered to one half of the track. The resulting fall of voltage generates an asymmetrical DCC signal. LokSound decoders are able to detect the potential difference between the left and right half of the signal. If desired, the decoder will be stopped.

To be able to use the ABC technique you also need, beside the adequate LokSound V4.0 decoder, an appropriate brake module. The ABC technique can only be operated with boosters offering an exact symmetrical output. All command stations and boosters by ESU and Lenz® guarantee a symmetrical output. We don't recommend to use other boosters for the ABC technique.

- If you wish to stop the LokSound decoder when the track signal is stronger on the right side than on the left side (and the diodes are also installed on the left side), set bit 0 in CV 27.
- If you wish to stop the LokSound decoder when the track signal is stronger on the left side than on the right side (and the diodes are

also installed on the right side), set bit 1 in CV 27.

- If you want to stop the decoder no matter in which half of the track the diodes are set, please set bit 0 and bit 1 in CV 27 (CV 27 = 3).

10.5.4.1 ABC "slow approach" section

The decoders also detect "slow approach" sectors implemented with the Lenz BM2 module. The desired speed in the slow approach sector can be adjusted with CV 123. The value 255 corresponds with full speed while the value 0 would stop the locomotive.

10.5.4.2. ABC detection threshold

In some operational situations it may happen that the LokSound decoder does not detect the ABC braking section. This may be caused by the wiring or the boosters respectively the braking diodes.

You can influence the detection sensitivity with the aid of CV 134. Change the default value (12) step by step and test until you achieve the desired result.

10.6. Constant Brake Distance

LokSound V4.0

LokSound micro V4.0

LokSound XL V4.0

LokSound V4.0 M4

An attractive function hides behind CV 254 (ESU brake mode): Here you can set a constant distance for braking the train, from the beginning of the brake sector to the stopping point. Thus, it is possible to stop the train right in front of a red signal regardless of the speed. The LokSound simply calculates the required brake effect.

The higher the value in CV 254, the longer is the brake distance. Simply make some trials on a test track in order to find the values best suited to your locomotive.

If CV 254 is set to 0, then the normal time mode according to chapter 10.1. will automatically turn on.

Adapting the Driving Characteristics

The constant brake distance is only active in brake sectors. When you turn the throttle back to 0, the locomotive will slow down as per the value in CV 4.

Via CV253 you can chose how the LokSound should decelerate.

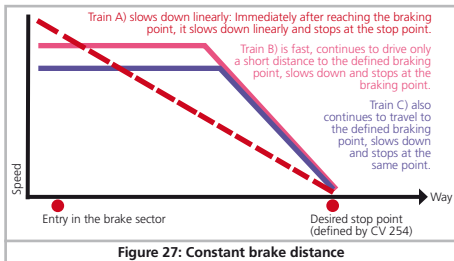

10.6.1. Linear Braking Distance

CV253=0: The loco starts immediately to stop linearly after receiving the braking command. The brake effort is determined by the decoder so that, independent from the starting speed, the loco will stop after reaching the way defined in CV254. The dashed line in Figure 27 shows the relation.

10.6.2. Constant Linear Braking Distance

CV253>0: Is the value in CV253 higher than 0, the locomotive continues to drive ahead for some time when entering the braking section to finally brake within the braking time indicated in CV253. The effort of the braking effect is now constant as set in CV253. The decoder changes the brake timing accordingly so that the locomotive stops at the correct position in the end. Figure 27 shows this quite clearly.

10.6.3. Push-pull trains

In order to assure that push-pull trains also stop at the correct point ahead of a red signal it is possible to set the braking distance for the reverse direction separately. This can be done with CV 255. If the value of CV 255 is greater than 0 then the value of CV 254 determines forward movement and CV 255 reverse movement. Typically the value for the reverse movement (driving trailer leads the train) is set for a shorter distance.

10.6.4. Braking at speed step 0

In order to apply the constant braking distance mode the decoder must generally detect a braking section. This may be disadvantageous, particularly when operation is computer controlled because the software transmits the "braking command" directly by setting speed step 0 even if there is no physical brake section. In order to assure that the LokSound V 4.0 responds to the brake command with constant braking distance can be achieved by setting bit 7 in CV 27. This results in the decoder braking whenever speed step 0 is set.

10.7. Settings for Analogue Operation

You can adjust the acceleration and maximum speed of the LokSound separately for analogue DC and AC mode. Thus, you can adapt the speed of your locomotive also to analogue operations.

You will have to determine suitable values by trial and error since they depend on the type of transformer (throttle) and the drive system of your locomotive.

Please note that load compensation is always active ex works, even in analogue mode. This gives you smooth control even at very low speeds.

Adapting the Driving Characteristics

10.7.1. DC Analogue Operation

LokSound V4.0

LokSound micro V4.0

LokSound XL V4.0

LokSound V4.0 M4

In DC analogue mode you can adjust the starting speed with the CVs 125 and the maximum speed with CV126.

The motor is switched off again as soon as the throttle voltage goes below a certain value. Normally this value is equal to the switch on voltage (CV 125) but can be lowered by an "Offset". This offset is stored in CV 130.

Functions such as lights and sound can be turned on in advance even when another (usually lower) voltage independent of the motor. To achieve this, the offset is written into CV 129.

The behaviour can be described as follows:

Motor on	CV 125
Motor off	CV 125 – CV 130
Functions on	CV 125 – CV 129
Functions off	CV 125 – CV 129 – CV 130

10.7.2. AC Analogue Operation

LokSound V4.0

LokSound XL V4.0

LokSound V4.0 M4

In AC analogue mode you can adjust the starting speed with CV 127 and the maximum speed with CV 128.

The motor is switched off again as soon as the throttle voltage goes below a certain value.

Normally this value is equal to the switch on voltage (CV 127) but can be lowered by an "Offset". This offset is stored in CV 130.

Functions such as lights and sound can be turned on in advance even when another (usually lower) voltage independent of the

motor. To achieve this, the offset is written into CV 129. The behaviour can be described as follows:

Motor on	CV 127
Motor off	CV 127 – CV 130
Functions on	CV 127 – CV 129
Functions off	CV 127 – CV 129 – CV 130

10.8. Motor brake

LokSound XL V4.0

If so desired the LokSound XL V4.0 decoder can short circuit the motor when the locomotive is stationary. This "fixing brake" can prevent the inadvertent rolling away of the locomotive on a downhill gradient respectively reduce the curl.

The motor brake can be turned on by setting bit 6 in CV 124.

The motor brake is only active as long as track voltage is available.



10.9. Configure the PowerPack „Switch off“ time

LokSound V4.0

LokSound micro V4.0

LokSound XL V4.0

LokSound V4.0 M4

When you connect an external capacitor or PowerPack, you are able to make the decoder switch off after a certain time. CV113 is responsible for that, since you are able to determine at what time the decoder is to switch off (as a multiple of 0.0164 seconds). You should set a time between 0.3 and 1.0 seconds to prevent your locos from driving too far during an emergency.

From firmware version 4.6, the LokSound decoder has installed an “energy saving mode”: If the decoder recognises a dirty spot on the tracks, it will automatically reduce its volume to save energy.

Usually you will barely notice the volume reduction, if at all. If you use larger capacitors or the PowerPack, the volume reduction is, however, unwelcome. Thus the volume reductions only active when value ≤ 10 is set in CV113.

11. Motor Control

LokSound V4.0

LokSound micro V4.0

LokSound XL V4.0

LokSound V4.0 M4

5th generation load compensation enables LokSound decoders to execute precise motor control. Even with the default settings, most locomotives run perfectly.

11.1. Adjusting Load Compensation

Should you find after programming and doing the initial test that the locomotive does not run smoothly particularly at low speed or that the locomotive jerks a little after having stopped or if you are simply unsatisfied with the driving performance, then you should adjust the load compensation of your LokSound decoder.

Due to the large number of different types of motors and drive systems there is no single setting that suits all. Load compensation can be influenced with 5 CVs.



Firstly, check if the irregular performance is due to any mechanical faults. Bent driving rods are one common cause. When you turn off load compensation (set CV56 to 0) and the problem persists then it is likely there is a mechanical fault.

11.1.1. Parameter for frequently used Motors

We have listed the correct settings for the most common motors in table fig. 28. If a motor is missing, it means either that the default settings produce good results or that we have not yet sufficient experience about these motors.

Set the suitable values and test-drive your locomotive.

11.1.2. Adjustments for other Motors / „Fine Tuning“

Unfortunately, the motors available in the market have considerable variations due to tolerances. This is even true for the same type. Therefore, LokSound decoders enable you to adapt load compensation to the motor with CVs 53, 54 and 55. If the recommended values above do not lead to acceptable results, you can further optimise them.

Especially for the slow driving sector (speed step 1) the LokSound V4.0 with CV 51 and CV 52 to change the gain control. This helps to avoid any jerking while driving extremely slowly.



However, before doing this you must make sure that there are no capacitors wired between the motor terminals and the chassis.

The commutator of the motor must be clean and the drive system should run freely. The wheel contacts and other contact plates of the locomotive must also be clean and make reliable contact.

11.1.2.1. Parameter „K“

Parameter „K“, stored in CV 54, influences how strongly load control will affect the driving performance. The higher the value, the more load control will respond to any changes and try to adjust the revs of the motor.

Parameter „K“ needs adjustment if the locomotive runs unevenly (jerks).

Reduce the value of CV 54 by 5 and test-run the locomotive to see if there are any improvements. Repeat these steps until the locomotive runs smoothly at speed step 1.

11.1.2.2. Parameter „I“

Parameter „I“, stored in CV 55, provides important information to the decoder on how much inertia the motor has. Motors with large flywheels naturally have more inertia than smaller ones or coreless motors.

Adjust parameter „I“ if the locomotive jerks somewhat just before it stops or „jumps“ at lower speeds (lower third of the speed step range) or simply does not run smoothly.

- Increase the value by 5 starting with the default value for motors with very small or no flywheels.
- Reduce the value by 5 starting with the default value for motors with large flywheels.

Test again and repeat this procedure until you arrive at the desired result.

11.1.2.3. Reference Voltage

In CV 53, you set the EMF reference voltage generated by the motor at maximum revs. This parameter may have to be adapted subject to the track voltage and the efficiency of the motor.

If the locomotive reaches maximum speed when the throttle is set to about three-quarter and the top third of the throttle has no influence on the speed, then you should reduce the value of CV 53. Reduce the value by 5 – 8 and test the locomotive again. Repeat this process until the locomotive just reaches its maximum speed when the throttle is fully open.

On the other hand, if the locomotive moves too slowly at full throttle then you should increase the value of CV 53 step by step until the maximum speed is reached.

11.1.2.4. Parameter “K slow”

Together with the LokSound V4.0 decoder an additional CV 52 has been introduced which separately determines the gain control considerably for the whole slow driving sector in speed step 1.

If you are not satisfied with the driving behaviour when the locomotive drives slowly or starts, while everything is fine with the medium and high speed steps, you should increase the value of CV 52 by ca. 5 - 10 than the value set in CV 54.

11.1.2.5. Parameter „I slow“

Here you can adjust the inertia of the motor separately for slow speeds and starting from a stop. The desired value is to be entered into CV 51. The parameters “K slow” and “I slow” jointly influence the behaviour at speed steps 1 and 2 while the parameters CV 54 (“K”) and CV 55 (“I”) are responsible for the remain-

Motor Control

ing speed steps. The decoder computes a speed curve in order to avoid any abrupt changes.

11.1.2.6. Adaptive Regulation Frequency

The decoder operates ex works with a mutable (adaptive) regulation frequency to drive the motor as precisely as possible. However, as a result some motors might show a nasty buzzing noise.

For such motors you are able to set the regulation frequency on a constant value. Set bit 4 to "1" in CV 124.

11.1.3. Automatic calibration of the motor

LokSound V4.0 decoders offer a feature for automatic calibration of the motor. In most cases this procedure leads to excellent load compensation characteristics. However, due to the infinite number of possible combinations of motors and gear boxes a good result cannot be guaranteed in all cases. But it is certainly worth a try.

Proceed as follows:

- Set the vehicle onto a piece of straight and preferably level track. This track must be at least as long as to allow the locomotive to

run at full speed for about two seconds. This movement takes place automatically during calibration. Provide buffer stops or something similar to prevent the locomotive from running off the track!

- Call up the locomotive on your throttle and make sure that F1 is switched off and the throttle is set to speed step 0. Set the direction of travel as desired.
- Write the value 0 into CV 54 (either on the programming track or with POM).
- Now press the "F1" button. The locomotive will start running at full speed automatically. During about 1.5 seconds you will not be able to control this locomotive!
- The locomotive will automatically stop and the identified load compensation parameters will be saved in the CVs 51, 52, 53, 54 and 55.

If you wish you can now further optimise the load control parameters starting from the calibrated settings.

Motor type	Remark	CV 2	CV 51	CV 52	CV 53	CV 54	CV 55	CV 56
Standard values (factory values)	for ROCO®, Liliput®, Brawa®	3	0	15	140	50	100	255
Fleischmann® round motor		4	0	32	112	80	50	255
Märklin® SFCM small	with magnet 51961	4	0	30	50	40	175	200
Märklin® SFCM large	with magnet 51960	4	0	30	50	40	175	200
Märklin® DCM	with magnet 51962	4	0	30	50	40	175	200
Märklin® 5*-high-performance motor		3	0	32	120	60	95	255
Märklin® / Trix locos with Maxon® motor	Remove the motor EMC capacitors!	3	0	16	140	48	20	255
HAG® motor		4	0	15	100	40	175	200
Faulhaber® motor		4	0	32	140	80	50	255
Piko® motor		3	0	20	80	30	30	255

Figure 28: Chart with load regulation values for commonly used motors

Motor Control

11.2. Turning off Load Compensation

LokSound V4.0

LokSound micro V4.0

LokSound XL V4.0

LokSound V4.0 M4

You can also switch off load compensation by writing the value 0 in CV 56 („Control Influence“).



With load control turned off, the starting voltage in CV 2 should be increased until the locomotive starts moving at speed step 1 or 2.

11.3. Adapting Load Control Frequency

LokSound V4.0

LokSound micro V4.0

LokSound XL V4.0

LokSound V4.0 M4

In the LokSound decoders load control works normally with 40 kHz. Sometimes it can be useful to reduce this frequency by half:

- For motors with little power due to high inductivity.
- If suppressors (such as capacitors, chokes, etc.) disturb load control but cannot be removed (e.g. some older Gützold@ locos).

Delete bit 1 in CV 49 in order to set the PWM frequency from 40 KHz to about 20 KHz.

11.4. Dynamic Drive Control: Up and Down the Hill

LokSound V4.0

LokSound micro V4.0

LokSound XL V4.0

LokSound V4.0 M4

Dynamic Drive Control of your LokSound decoder enables you to adapt load control, as you may desire. Full control over the entire speed range (constant speed, if enough power is available) is not always prototypical. Therefore you can set the degree to which load control will be effective between 0 (no load control) and 100% (load compensation over the full range).

At low speeds it is advisable to have 100% load compensation in order to prevent the locomotive from „getting stuck“ or from „running away“ without any load. The impact of load control should recede with increasing speed in order to have the full „unharnessed“ power of the motor available when the throttle is fully open. Thus, the locomotive will respond to certain changes in the main line such as gradients. The locomotive will run faster downhill and become slower climbing the hill.

The desired degree of load control influence is set in CV 56.



It is particularly meaningful to reduce the influence of load control whenever you run consists. This allows for better driving properties of all locomotives in the consist.

11.5. Settings for the C-Sinus Motor

LokSound decoders with the 21MTC interface can drive the new C-Sinus motors indirectly via the circuit board installed in the locomotive. The LokSound can generate all necessary signals provided you readjust certain settings:

Load compensation must be turned off as described in chapter 11.2.

The control electronics of the motor also need a switched logic voltage provided by the LokSound on output AUX4. AUX4 must therefore be active while the locomotive is stopped and while it is moving (in both directions!).

LokSound V4.0

LokSound micro V4.0

LokSound XL V4.0

LokSound V4.0 M4



Write the values below into the respective CVs.

Make sure that CV 31 contains the value 16 and CV 32 the value 2.

CV	Value
CV 266	32
CV 282	32
CV 298	32
CV 314	32

Use the LokProgrammer alternatively in order to activate AUX4 for the stationary locomotive and for the moving locomotive in both directions as shown in figure 29.

Furthermore for certain models the serial interface (SUSI) must be activated since the control electronics receive their commands via this interface. Turn on SUSI by setting bit 3 in CV 124. Based on the default value for CV 124 (20) you should now write 28 into CV 124.

Unfortunately there is another hurdle to be taken: The C-Sinus circuit board draws too much energy from the LokSound decoder. If you have activated RailCom or Märklin brake sections there may be some erroneous behaviour. To rectify this connect a 470 µF capacitor between U+ and the common of the decoder as shown in chapter 6.10.2.

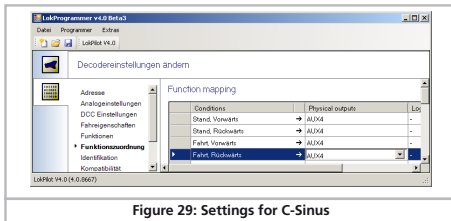

Figure 29: Settings for C-Sinus

12. Function outputs

12.1. Physical function outputs

LokSound decoders have up to 12 physical function outputs. „Headlights“ and „Rearlights“ are used for lighting, the remaining ones are freely available. Other functions include „Shunting Mode“, „Acceleration / Deceleration On/Off“ as well as virtual functions like „Sound On/Off“.

The function buttons („F buttons“) of your command station or throttle activate the function outputs.

Generally, F0 is the lighting button, while we count the remaining buttons from F1 upwards.

12.2. Allocation of Function Buttons (Function Mapping)

LokSound V4.0

LokSound micro V4.0

LokSound XL V4.0

LokSound V4.0 M4

You can allocate the functions freely to any function button. ESU uses the so-called and once more extended „Mapping“ for the LokSound V4.0 decoder. It has the advantage that you can link each output to any button. Furthermore, the allocation can vary between forward and reverse as well. It is also possible to switch several functions simultaneously. Unfortunately this kind of flexibility requires a large amount of CVs. The solution of this problem is called „Index CV access“.

12.2.1. Index CV access

The CVs ranging from 257 – 511 are „indexed“. This means that the meaning of any of these CVs can change depending on the value of the so-called „Index register“.

If you change the value of the index register, the meaning and the value of the CV itself will be also changed. This method allows to use every CV between 257–511 several times and solves the problem regarding CV shortage.

Function outputs

CV 31 and CV 32, which are also so-called “index register”, determines the meaning of CV 257–511 as well. If you change both the CVs 31 and 32, you simultaneously change the meaning and the values of CV 257–511.



The meaning of all other CVs (1–256) is not influenced by the value of the index register.

So should you ever change any of the CVs located in the range from 257, please make sure first that the index registers CV31 and CV32 have the indicated values.



At this state, CV 31 must always have value 16. CV 32 may have the values 0, 1, 2, 3 or 4.

12.2.2. Function Mapping Chart

The LokSound V4.0 decoder offers powerful and flexible function mapping options:

- Each function button can switch as many outputs as desired
- Each output can be activated by several function buttons
- Function buttons can be linked (e.g.: F3 AND F5 pressed simultaneously)
- Function buttons can be inverted (e.g.: NOT when F8 is on)
- Besides the buttons F0 to F28 you can also incorporate the direction of travel or the speed (locomotive is moving / has stopped)
- You may connect as many as 5 external sensors

While many model train enthusiasts need precisely these functions for optimal running of all their locomotives setting up function mapping represents so to speak the “free style” version of decoder programming. Take your time to understand the concept behind it before you start changing any settings.

All desired actions to be carried out by the decoder are saved in an internal table. Let’s first have a look at the principal structure as it is shown in the chart on the next page. Two main groups can be seen:

- The input block (conditions block) shows which condition is required to achieve a certain output. Conditions are for instance “F3 On” or “Locomotive is stationary with direction set to forward, and F8 is switched on”.
- In the output block it is shown what action must be carried out when the condition(s) is/are met. This could be, for instance, switching a function output or a sound effect.

The table always has 40 entries, the so called “mapping rows”. The decoder works continuously through this table from top to bottom (row 1 to 40) and checks for each mapping row if the conditions set in the input block are met. ONLY THEN the decoder looks at the desired activities in the output block and carries them out. After that it jumps to the next row and once it has reached the bottom row it starts from the top again. This occurs several 100 times per second.

The conditions of each block are stored in CVs. There are 9 CVs per mapping row reserved for the input block and 7 CVs for the output block. The respective CVs responsible for each mapping row are listed in the table. These CVs are numbered from “A” to “Q” and are called control CVs.



Since all CVs are within the index area the appropriate value for CV 32 is also listed. Prior to changing any CVs you should ascertain that the index CVs are set to the values shown in the table.

Function outputs

Mapping line	CV 32	Conditions block (input block)									Physical outputs		Logic outputs		Sound functions		
		CV A	CV B	CV C	CV D	CV E	CV F	CV G	CV H	CV I	CV K	CV L	CV M	CV N	CV O	CV P	CV Q
1	2	257	258	259	260	261	262	263	264	265	266	267	268	269	270	271	272
2	2	273	274	275	276	277	278	279	280	281	282	283	284	285	286	287	288
3	2	289	290	291	292	293	294	295	296	297	298	299	300	301	302	303	304
4	2	305	306	307	308	309	310	311	312	313	314	315	316	317	318	319	320
5	2	321	322	323	324	325	326	327	328	329	330	331	332	333	334	335	336
6	2	337	338	339	340	341	342	343	344	345	346	347	348	349	350	351	352
7	2	353	354	355	356	357	358	359	360	361	362	363	364	365	366	367	368
8	2	369	370	371	372	373	374	375	376	377	378	379	380	381	382	383	384
9	2	385	386	387	388	389	390	391	392	393	394	395	396	397	398	399	400
10	2	401	402	403	404	405	406	407	408	409	410	411	412	413	414	415	416
11	2	417	418	419	420	421	422	423	424	425	426	427	428	429	430	431	432
12	2	433	434	435	436	437	438	439	440	441	442	443	444	445	446	447	448
13	2	449	450	451	452	453	454	455	456	457	458	459	460	461	462	463	464
14	2	465	466	467	468	469	470	471	472	473	474	475	476	477	478	479	480
15	2	481	482	483	484	485	486	487	488	489	490	491	492	493	494	495	496
16	2	497	498	499	500	501	502	503	504	505	506	507	508	509	510	511	512
17	3	257	258	259	260	261	262	263	264	265	266	267	268	269	270	271	272
18	3	273	274	275	276	277	278	279	280	281	282	283	284	285	286	287	288
19	3	289	290	291	292	293	294	295	296	297	298	299	300	301	302	303	304
20	3	305	306	307	308	309	310	311	312	313	314	315	316	317	318	319	320
21	3	321	322	323	324	325	326	327	328	329	330	331	332	333	334	335	336
22	3	337	338	339	340	341	342	343	344	345	346	347	348	349	350	351	352
23	3	353	354	355	356	357	358	359	360	361	362	363	364	365	366	367	368
24	3	369	370	371	372	373	374	375	376	377	378	379	380	381	382	383	384
25	3	385	386	387	388	389	390	391	392	393	394	395	396	397	398	399	400
26	3	401	402	403	404	405	406	407	408	409	410	411	412	413	414	415	416
27	3	417	418	419	420	421	422	423	424	425	426	427	428	429	430	431	432
28	3	433	434	435	436	437	438	439	440	441	442	443	444	445	446	447	448
29	3	449	450	451	452	453	454	455	456	457	458	459	460	461	462	463	464
30	3	465	466	467	468	469	470	471	472	473	474	475	476	477	478	479	480
31	3	481	482	483	484	485	486	487	488	489	490	491	492	493	494	495	496
32	3	497	498	499	500	501	502	503	504	505	506	507	508	509	510	511	512
33	4	257	258	259	260	261	262	263	264	265	266	267	268	269	270	271	272
34	4	273	274	275	276	277	278	279	280	281	282	283	284	285	286	287	288
35	4	289	290	291	292	293	294	295	296	297	298	299	300	301	302	303	304
36	4	305	306	307	308	309	310	311	312	313	314	315	316	317	318	319	320
37	4	321	322	323	324	325	326	327	328	329	330	331	332	333	334	335	336
38	4	337	338	339	340	341	342	343	344	345	346	347	348	349	350	351	352
39	4	353	354	355	356	357	358	359	360	361	362	363	364	365	366	367	368
40	4	369	370	371	372	373	374	375	376	377	378	379	380	381	382	383	384

Function outputs

12.2.2.1. Conditions block

Each condition block of each mapping row consists of 9 control CVs. Each CV defines four conditions.

Name	Description	Value
Control CV A	Loco drives	1
	Loco stops	2
	Direction is forward	4
	Direction is backward	8
	Key F0 is On	16
	Key F0 is Off	32
	Key F1 is On	64
	Key F1 is Off	128
Control CV B	Key F2 is On	1
	Key F2 is Off	2
	Key F3 is On	4
	Key F3 is Off	8
	Key F4 is On	16
	Key F4 is Off	32
	Key F5 is On	64
	Key F5 is Off	128
Control CV C	Key F6 is On	1
	Key F6 is Off	2
	Key F7 is On	4
	Key F7 is Off	8
	Key F8 is On	16
	Key F8 is Off	32
	Key F9 is On	64
	Key F9 is Off	128
Control CV D	Key F10 is On	1
	Key F10 is Off	2
	Key F11 is On	4
	Key F11 is Off	8
	Key F12 is On	16
	Key F12 is Off	32
	Key F13 is On	64
	Key F13 is Off	128

Control CV E	Key F14 is On	1
	Key F14 is Off	2
	Key F15 is On	4
	Key F15 is Off	8
	Key F16 is On	16
	Key F16 is Off	32
	Key F17 is On	64
	Key F17 is Off	128
Control CV F	Key F18 is On	1
	Key F18 is Off	2
	Key F19 is On	4
	Key F19 is Off	8
	Key F20 is On	16
	Key F20 is Off	32
	Key F21 is On	64
	Key F21 is Off	128
Control CV G	Key F22 is On	1
	Key F22 is Off	2
	Key F23 is On	4
	Key F23 is Off	8
	Key F24 is On	16
	Key F24 is Off	32
	Key F25 is On	64
	Key F25 is Off	128
Control CV H	Key F26 is On	1
	Key F26 is Off	2
	Key F27 is On	4
	Key F27 is Off	8
	Key F28 is On	16
	Key F28 is Off	32
	Wheel sensor is On	64
	Wheel sensor is Off	128

Function outputs

Control CV I	Sensor 1 is On	1
	Sensor 1 is Off	2
	Sensor 2 is On	4
	Sensor 2 is Off	8
	Sensor 3 is On	16
	Sensor 3 is Off	32
	Sensor 4 is On	64
	Sensor 4 is Off	128

The value to be written into each control CV is easily established: simply add the values of the desired conditions.

Example: You want F0 to be switched on while the locomotive is stationary and set to direction forward and while F4 is switched off. Therefore you write the value $4 + 16 = 20$ into the control CV A and the value 32 into the control CV B. All other CVs remain on 0. Thus these conditions are ignored. The previous table shows into which CVs you have to write the values.

The input block for the first mapping row lies between CV 257 (control CV A) and CV 265 (control CV I).



LokSound V4.0 decoders support 5 sensor inputs. The wheel sensor, though, is only available on LokSound V4.0 and LokSound V4.0 M4. In addition to the inputs mentioned before sensor inputs 1 and 2 are available on LokSound XL V4.0. Physically there are no sensors on LokSound micro V4.0. Nevertheless you can use them in mapping because these sensors could be on add-on circuit boards (e.g.: as is the case in the locomotives of the ESU Engineering Edition).

12.2.2.2. Physical function outputs

Physical function outputs are outputs that are actually built into the decoder where you can connect “real” loads by means of wires. Up to 12 outputs are conceivable.

The decoders are equipped as follows:

Output	LokSound V4.0	LokSound micro V40	LokSound V4.0 M4	LokSound XL V4.0
Headlight	Ok	Ok	Ok	Ok
Rearlight	Ok	Ok	Ok	Ok
AUX1	Ok	Ok	Ok	Ok
AUX2	Ok	Ok	Ok	Ok
AUX3	Logic (PluX: Ok)	-	Ok (21MTC: Logic)	Ok
AUX4	Logic (PluX: Ok)	-	Ok (21MTC: Logic)	Ok
AUX5	-	-	-	Ok
AUX6	-	-	-	Ok
AUX7	-	-	-	Ok
AUX8	-	-	-	Ok
AUX9	-	-	-	Ok
AUX10	-	-	-	Ok

Nevertheless you can map all outputs since additional outputs could be installed on separate circuit boards (e.g.: ESU I/O expansion circuit board). They are fully integrated into the function mapping.

The block for the physical outputs of each mapping row covers two CVs. The meaning of those CVs is as follows:

Name	Description	Value	
Control CV K	Output headlight On [Conf. 1]	1	
	Output rearlight On [Conf. 1]	2	
	Output AUX1 On [Conf 1.]	4	
	Output AUX2 On [Conf 1.]	8	
	Output AUX3 On	16	
	Output AUX4 On	32	
	Output AUX5 On	64	
	Output AUX6 On	128	

Function outputs

Name	Description	Value
Control CV L	Output AUX7 On	1
	Output AUX8 On	2
	Output AUX9 On	4
	Output AUX10 On	8
	Output headlight On [Conf. 2]	16
	Output rearlight On [Conf. 2]	32
	Output AUX1 On [Konf 2.]	64
Output AUX2 On [Konf 2.]	128	

You must add the value for the control CV for each output you want to switch. Into which CV exactly you must write a value you can find in the overview table on page 53. For mapping row 1 they are, for instance, CVs 266 (control CV K) and CV 267 (control CV L).



The lighting outputs front and rear as well as the outputs AUX1 and AUX2 are duplicated. These outputs can be configured twice (configuration [1] and configuration [2]). Thus you can determine by pressing the appropriate function button which of the two possible configurations should be active. This enables you, for example, to set up upper beam and lower beam headlights (bright and dim). Please refer to chapter 12.3. for more information.

12.2.2.3. Logical outputs

Under the heading logical outputs we have compiled all functions that either directly or indirectly “dynamically” influence the behaviour of the decoder. Often these functions are only effective in conjunction with other settings.

The following functions are envisaged:

- Switching off acceleration and braking deceleration delay.
- Shunting mode: the locomotive moves at half speed.
- Dynamic brakes: braking times are doubled.
- Smoke generator: Clocked smoke generators (ESU, KM-1®, Kiss®) are switched on.
- Diesel notch “Up” and Diesel notch “Down”: this enables you to set the speed step of the diesel (sound) independent from the

actual speed. This is particularly useful for diesel-electric locomotives, especially American types. With this feature one can rev up the diesel engine in order to simulate a high load. As soon as the manual diesel notch selection is active, the revs of the diesel (sound) are independent of the actual speed until the locomotive has come to a complete stop and the appropriate function buttons have been switched off.

- Sound fader: the sound is faded out once this feature is active. This is useful for tunnel simulation.
 - Deactivating braking sound: no brake sound is played, if active.
 - Doppler: a Doppler effect can be simulated subject to the speed, if active.
 - Volume control: every time you press the button (and release it again) the sound volume is reduced a bit. When pressed again full volume is restored. This is useful for setting the desired volume during operation without having to program at the same time.
 - Shift mode: Sets the global status “Shift” mode. This may be employed by some sound projects in order to play certain sounds.
- In addition there are three functions which influence the functionality of physical function outputs. They work together with various lighting effects of the physical outputs. You find more info in chapter 12.3.
- Fire box: if set, an LED simulating the fire box varies the brightness.
 - Dimmer: if set, all outputs are dimmed to about 60% darker provided the outputs have been set to “Dimming down”.
 - Grade crossing: sets the grade crossing function for the appropriately configured outputs for American models.

As is the case with the physical outputs the logical outputs are also represented by two CVs in the mapping row. The arrangement within the CVs is as follows:

Function outputs

Name	Description	Value
Control CV M	Switching off acceleration and braking deceleration	1
	Shunting mode	2
	Dynamic brakes	4
	Fire box	8
	Dimmer (low beam headlights)	16
	Grade crossing	32
	Reserved	64
	Reserved	128
	Control CV N	Clocked smoke generator (ESU, KM-1, Kiss)
Diesel notch "Up"		2
Diesel notch "Down"		4
Sound fader		8
Deactivating braking sound		16
Doppler		32
Volume control		64
Shift mode		128

You must add the value for the control CV for each output you wish to switch. Into which CVs exactly you must write these values you can find in the overview table on page 53. For mapping row 1 they are, for instance, CVs 268 (control CV M) and CV 269 (control CV N).

12.2.2.4. Sound functions

Of course you can trigger sound functions within any mapping row. For this purpose all sounds are assigned to "Sound slots". You can determine which sound slots (even several simultaneously) should be triggered by which function button.

The running sound (engine sound) is always stored in sound slot 1. In some locomotives and almost all steam locomotives the sound slots 2 and 24 are also responsible for running sounds. In these cases they are jointly switched with one function button.

There are three CVs dedicated for sound functions in each mapping row:

Name	Description	Value
Control CV O	Soundslot 1 (Driving sound)	1
	Soundslot 2	2
	Soundslot 3 (mostly horn or whistle)	4
	Soundslot 4	8
	Soundslot 5	16
	Soundslot 6	32
	Soundslot 7	64
	Soundslot 8	128
Control CV P	Soundslot 9	1
	Soundslot 10	2
	Soundslot 11	4
	Soundslot 12	8
	Soundslot 13	16
	Soundslot 14	32
	Soundslot 15	64
	Soundslot 16	128
Control CV Q	Soundslot 17	1
	Soundslot 18	2
	Soundslot 19	4
	Soundslot 20	8
	Soundslot 21	16
	Soundslot 22	32
	Soundslot 23	64
	Soundslot 24	128

You must add the value for the control CV for each output you wish to switch on. Into which CVs exactly you must write these values you can find in the overview table on page 53. For mapping row 1 they are, for instance, CVs 270 (control CV O) and CV 271 (control CV Q).



Theoretically you can activate all 24 sound slots by pressing one function button. However, the LokSound V4.0 will only play eight of them simultaneously.

12.2.3. Standard mapping - LokSound V4.0 / micro decoder

Both decoders - LokSound V4.0 and LokSound micro V4.0 – have identical function mapping.



Of course, which sound is assigned to which sound slot may vary depending on the decoder project. You will find a list with all available project files “Download/Sound files/LokSoundV4.0/” on our home page at www.esu.eu. You may also view and print a list with all functions and the sound slots employed.

Functions (LokSound)			
Key	Function	Soundslots	Volume CVs
Light	Front light, dynamo		
F1	Sound on/off		
F2	medium pitched whistle		
F3	bell		
F4	coal shoveling		
F5	airpump		
F6	Acceleration/brake time, Shunting Mode/Shunting speed		
F7	curve squeal		
F8	AUX1		
F9	blow out		
F10	conductors signal		
F11	coupler sound		
F12	sanding		
F13	brake set		
F14	station announcement #1		
F15	whistle short		
F16	safety valve		
F17	railclank		
F18	dumping		
F19	water pump		
F20	injector		

Figure 30: Funktionstastenbelegung BR98.10 Lokalbahn

Function outputs

Standard mapping - LokSound V4.0 / LokSound micro V4.0

Line	Conditions block	Description	Physical Outpts	Logic functions	Sound functions
1	FS, fwd	Stop, forward			
2	FS, rev	Stop, backward			
3	FF, fwd	Run, forward			
4	FF, rev	Run, backward			
5	F0, fwd	Light key, forward	Headlight		
6	F0, rev	Light key, backward	Rearlight		
7	F1	Key F1			Soundslot 1 (Driving sound)
8	F2	Key F2			Soundslot 3
9	F3	Key F3			Soundslot 4
10	F4	Key F4			Soundslot 5
11	F5	Key F5			Soundslot 6
12	F6	Key F6		ABV off, Shunting mode	
13	F7	Key F7			Soundslot 15
14	F8	Key F8	AUX1[1]		
15	F9	Key F9			Soundslot 9
16	F10	Key F10			Soundslot 10
17	F11	Key F11			Soundslot 8
18	F12	Key F12			Soundslot 11
19	F13	Key F13			Soundslot 13
20	F14	Key F14			Soundslot 7
21	F15	Key F15			Soundslot 16
22	F16	Key F16			Soundslot 12
23	F17	Key F17			Soundslots 17, 18
24	F18	Key F18			Soundslot 14
25	F19	Key F19			Soundslot 20
26	F20	Key F20			Soundslot 21
27	F21	Key F21			Soundslot 22
28					
29					
30					
31					
32					
33					
34					
35					
36					
37					
38					
39					
40					

Function outputs

Standard mapping - LokSound V4.0 M4

Line	Conditions block	Description	Physical Outputs	Logic functions	Sound functions
1	F0, fwd	Light key, forward	Headlight		
2	F0, rev	Light key, backward	Rearlight		
3	F1, fwd	Key F1, forward			Soundslot 1 (Driving sound)
4	F1, rev	Key F1, backward			Soundslot 1 (Driving sound)
5	F2, fwd	Key F2, forward			Soundslot 3
6	F2, rev	Key F2, backward			Soundslot 3
7	F3, fwd	Key F2, forward			Soundslot 4
8	F3, rev	Key F2, backward			Soundslot 4
9	F4, fwd				Soundslot 5
10	F4, rev				Soundslot 5
11	F5, fwd				Soundslot 6
12	F5, rev				Soundslot 6
13	F6, fwd			ABV off, Shunting mode	Soundslot 15
14	F6, rev			ABV off, Shunting mode	
15	F7, fwd				Soundslot 15
16	F7, rev				Soundslot 15
17	F8, fwd		AUX1[1]		
18	F8, rev		AUX1[1]		
19	F9, fwd				Soundslot 9
20	F9, rev				Soundslot 9
21	F10, fwd				Soundslot 10
22	F10, rev				Soundslot 10
23	F11, fwd				Soundslot 8
24	F11, rev				Soundslot 8
25	F12, fwd				Soundslot 11
26	F12, rev				Soundslot 11
27	F13, fwd				Soundslot 13
28	F13, rev				Soundslot 13
29	F14, fwd				Soundslot 7
30	F14, rev				Soundslot 7
31	F15, fwd				Soundslot 16
32	F15, rev				Soundslot 16
33	FS, fwd	Stop, Forward			
34	FS, rev	Stop, Backward			
35	FF, fwd	Run, forward			
36	FF, rev	Run, backward			
37	SWheel, fwd	Wheel sensor, forward			
38	SWheel, rev	Wheel sensor, backward			
39	S1, fwd	Sensor 1, forward			
40	S1, rev	Sensor 1, backward			

Function outputs

Standard mapping - LokSound XL V4.0

Line	Conditions block	Description	Physical Outputs	Logic functions	Sound functions
1	F0, fwd	Light key, forward	Headlight		
2	F0, rev	Light key, backward	Rearlight		
3	F1	Key F1			Soundslot 1 (Driving sound)
4	F2	Key F2			Soundslot 3
5	F3	Key F3			Soundslot 4
6	F4	Key F4			Soundslot 5
7	F5	Key F5			Soundslot 6
8	F6	Key F6		ABV off, Shunting mode	Soundslot
9	F7	Key F7			Soundslot 15
10	F8	Key F8	AUX1[1]		
11	F9	Key F9			Soundslot 9
12	F10	Key F10			Soundslot 10
13	F11	Key F11			Soundslot 8
14	F12	Key F12			Soundslot 11
15	F13	Key F13			Soundslot 13
16	F14	Key F14			Soundslot 7
17	F15	Key F15			Sounslot 16
18	FS, fwd	Stop, Forward			
19	FS, rev	Stop, backward			
20	FF, fwd	Run, forward			
21	FF, rev	Run, backward			
22	SWheel	Wheel sensor			
23	S1	Sensor 1			
24	F16	Key F16			Soundslot 12
25	F17	Key F17			Soundslot 17, 18
26	F18	Key F18			Soundslot 14
27	F19	Key F19			Soundslot 20
28	F20	Key F20			Soundslot 21
29	F21	Key F21			Soundslot 22
30	F22	Key F22	AUX2[1]		
31	F23	Key F23	AUX3		
32	F24	Key F24	AUX4		
33	F25	Key F25	AUX5		
34	F26	Key F26	AUX6		
35	F27	Key F27	AUX7		
36	F28	Key F28	AUX8		
37					
38					
39					
40					

12.2.4. Standard mapping - LokSound V4.0 M4

Unfortunately the standard function mapping of the LokSound V4.0 M4 decoder had to be modified somewhat. The reason lies in the mfx® system that cannot deal with the flexible system of the LokSound V4.0. Therefore we have used the same mfx® function mapping as with the LokSound V3.0 M4 decoder. However, mfx® only supports 16 function buttons.

12.2.5. Standard mapping - LokSound XL V4.0

The LokSound XL V4.0 must bridge the gap between full M4 compatibility and as many functions as possible for DCC users. The mapping for the LokSound V4.0 M4 as shown above cannot cope with this since it only supports 16 function buttons. On the other hand the number of mapping rows is limited to 40. Therefore we had to find another way in order to fully utilize the potential of these decoders.

The solution is to only control a limited number of function outputs subject to the direction of travel. Thus we could cut down on the number of rows required.

12.2.5.1. Programming LokSound XL V4.0 with Central Station 2

Of course an mfx® command station always expects two mapping rows per function button. This problem is solved due to the fact that the decoder actually simulates two rows per button on the mfx® central unit even though there is only one row in reality. This happens in a transparent manner.

The only thing you have to bear in mind when programming a LokSound XL V4.0 decoder with a Märklin® mfx® central unit (e.g.: Central Station 2) that the rows for “reversing” cannot be changed. They are ignored when saving the data. If you wish to convert one row subject to direction at a later stage we recommend to use an ESU ECoS command station (in DCC mode) or to use the ESU LokProgrammer.

12.2.5.2 Example

Example: Switching AUX3 with F8. Assuming you have a LokSound V4.0 decoder and you want to switch AUX 3 with the button F8 subject to direction of travel. With the help of the ESU adapter board 51968 you added a light bulb to AUX 3.

A glance at the table “Standard mapping LokSound V4.0” on page 59 shows that nothing has to be changed in the input block. F8 has already been entered in mapping row 14.

As per the table in chapter 12.2.2.2., we must set the first CV of the block to 16 in order to activate AUX3. From the overview table on page 53 we determine that this must be CV 474 (Index 2). Therefore we first must set CV 32 to value 2 and then CV 474 to the value of 16.

For this example to work the AUX3 output must also be switched on. This is explained in chapter 12.3.

12.2.6. Allocation of Function Keys with the LokProgrammer

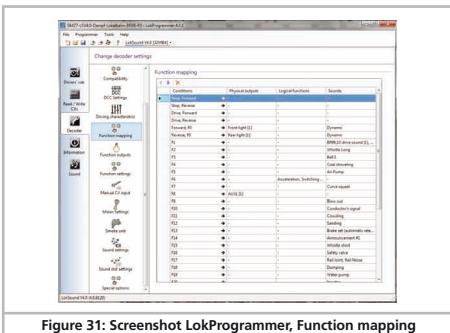

Figure 31: Screenshot LokProgrammer, Function mapping

Function outputs

Although programming the function outputs with the aid of an ESU ECoS respectively with any other DCC compliant command station is possible this procedure can be handled far easier with the ESU LokProgrammer and a PC. Its graphic interface simplifies the assignment of functions considerably. We recommend using the software version 4.3.x. in order to be able to utilise all potential options.

12.3. Special Effects on Function Outputs

12.3.1. Switching on Outputs and Different Options

Each function output can / must be unlocked prior to using it. Furthermore each output can be set to a certain effect and can be combined with the global function "Grade crossing", "Dimmer" and "Fire box".

Effects are divided into lighting effects and sound effects.

The following lighting effects are available:

- Dimmable light: A normal continuous output. The brightness will be reduced to about 50% if the dimmer function is on.
- Dimmable headlight with "fade in/out": Here the output is switched on slowly and imitates the slow glowing of oil lamps or very old light bulbs. The brightness will be reduced to about 50% if the dimmer function is on.
- Firebox: Simulates a normal fire box lighting effect.
- Intelligent firebox: Simulates an "intelligent" fire box lighting effect, whose intensity changes relating to the driving conditions.
- Single Strobe: This is a single strobe light (short flashing) output. The frequency can be adjusted.
- Double Strobe: This will result in two short flashes. The frequency can be adjusted.
- Rotary Beacon: This effect should simulate a revolving reflector and bulb assignment of a very popular warning beacon atop many diesels of the 60's and 70's.
- Prime Stratolight: This is the more modern version of the Rotary beacon.
- Ditch Light Type 1: The ditch light type 1 will revert to a steady On

state when it is not flashing.

- Ditch Light Type 2: The ditch light type 2 will revert to Off state when it is not flashing.
- Oscillator: A warning signal required in the USA.
- Flashing light: This is the "classical" flashing light. The frequency can be adjusted.
- Mars Light: This effect simulates the sweeping pattern of this well-known warning beacon in the USA.
- Gyra Light: The Gyra Light is similar to the Mars Light, but is slower in motion.
- FRED: „Flashing End of Train Device“: simulates the flashing red light indicating the end of a train in America.
- Fluorescent lamp: simulates the typical starting characteristics of a fluorescent lamp.
- Energy saving lamp: simulates the typical starting of modern energy saving lamps.

The following special functions are available:

- Fan control: here a small electric motor is slowly run up to high revs and then back down again. This is often used for fan motors that continue to run for a while.
- Seuthe® smoke generator: the intensity is reduced whenever the locomotive is stationary.
- Exhaust chuff trigger: the output generates a control pulse for clocked smoke generators by KM-1 (after market) or Massoth®.
- Servo: an RC servo can be connected to this output (only for Lok-Sound XL V4.0, outputs AUX7 through AUX10).
- Conventional coupler function: You can use this function to control Krois® couplers, also in connection with automatic pushing/removing.
- ROCO® coupler function: You can use this function to control ROCO® couplers, also in connection with automatic pushing/removing.
- Panto: this function is needed for ESU locomotives with functional pantographs.

Function outputs

- Servo coupler function: this is for using a servo for un-coupling and simultaneous pushing against the train and subsequent moving away.

12.3.2. Adjusting the Lighting Effects

The LokSound V4.0 provides 6 CVs for each physical output, which defines their behaviour.

- LED mode: The light outputs are pre-set to be used with incandescent bulbs. If you wire LEDs on the output, you should set this option in order to let the decoder know about it. The light effects will be accordingly adjusted, so that the result will look more realistic again.

For each physical output, the three controlling CVs are defined as follows:



Please set index register CV 31 to 16 and CV 32 to 0 before changing any of the above-mentioned CVs.



Please note that there are two complete sets of output configurations for the headlights (light forward, backup light) and AUX1 and AUX2. This enables you to program some special effects in conjunction with the function mapping.

In order to set each output, you should proceed as follows:

1. From the chart fig. 20 on the previous page, select the value for the Mode Select CV.
2. Compute the value for the Special Function CV by adding the values you can find in the chart figure 20 below the corresponding special function.
3. Define the value for the desired brightness.
4. Write the values into the CV corresponding to the appropriate function output.

Function output	Mode Select CV	Switching-on/-off delay	Automatic Switch off	Brightness CV	Special Function CV 1	Special Function CV 2
Headlight (Config. 1)	259	260	261	262	263	264
Rearlight (Config. 1)	267	268	269	270	271	273
AUX1 Config. 1	275	276	277	278	279	280
AUX2 Config. 2	283	284	285	286	287	288
AUX3	291	292	293	294	295	296
AUX4	299	300	301	302	303	304
AUX5	307	308	309	310	311	312
AUX6	315	316	317	318	319	320
AUX7	323	324	325	326	327	328
AUX8	331	332	333	334	335	336
AUX9	339	340	341	342	343	344
AUX10	347	348	349	350	351	352
Headlight (Config. 2)	355	356	357	358	359	360
Rearlight (Config. 2)	363	364	365	366	367	368
AUX1 (Config. 2)	371	372	373	374	375	376
AUX2 (Config. 2)	379	380	381	382	383	384

Figure 32: LED mode

Function outputs

Lighting effects	Mode Select	Switching-on/-off delay	Automatic Switch-off	Function parameters		Special function CV 1	
					Value	Change phase	Grade XING
Dimmable light	1	0 – 255	0 – 255	Brightness	0 – 31		
Dimmable headlight "fade in/out"	2	0 – 255	0 – 255	Brightness	0 – 31		
Firebox	3	0 – 255	0 – 255	Brightness	0 – 31		
Intelligent firebox	4	0 – 255	0 – 255	Brightness	0 – 31		
Single Strobe	5	0 – 255	0 – 255	Brightness	0 – 31	1	2
Double Strobe	6	0 – 255	0 – 255	Brightness	0 – 31	1	2
Rotary Beacon	7	0 – 255	0 – 255	Brightness	0 – 31	1	2
Prime Stratolight	8	0 – 255	0 – 255	Brightness	0 – 31	1	2
Ditch Light Type 1	9	0 – 255	0 – 255	Brightness	0 – 31	1	2
Ditch Light Type 2	10	0 – 255	0 – 255	Brightness	0 – 31	1	2
Oscillator	11	0 – 255	0 – 255	Brightness	0 – 31	1	2
Blinklicht	12	0 – 255	0 – 255	Brightness	0 – 31	1	2
Mars Light	13	0 – 255	0 – 255	Brightness	0 – 31	1	2
Gyra Light	14	0 – 255	0 – 255	Brightness	0 – 31	1	2
FRED	15	0 – 255	0 – 255	Brightness	0 – 31	1	2
Fluorescent lamp	16	0 – 255	0 – 255	Brightness	0 – 31	Starting time (0 – 255)	
Energy saving lamp	17	0 – 255	0 – 255	Brightness	0 – 31	Starting time (0 – 255)	
Fan control	23	0 – 255	0 – 255	Fan speed	0 – 31	Acceleration time (0 – 31)	
Seuthe® smoke generator	24	0 – 255	0 – 255	Heating level during stop	0 – 31	Heating level on speed step	
Exhaust chuff trigger	25	0 – 255	0 – 255	Coupling power	0 – 31		
Servo (*)	27	0 – 255	0 – 255		0 – 63	End position „A“ (0 – 63)	
Conventional coupler function	28	0 – 255	0 – 255	End position panto	0 – 31		
ROCO® coupler function (**)	29	0 – 255	0 – 255	Running time			
Panto (***)	30	0 – 255	0 – 255	Endposition des Stromabnehmers	0 – 15		
Servo coupler function (*)	31	0 – 255	0 – 255	Laufzeit	0 – 63	End position „A“ (0 – 63)	

(*) Only for LokSound XL V4.0, only AUX7 to AUX10

(**) Only for LokSound V4.0, LokSound micro V4.0, LokSound V4.0 M4, only AUX1 to AUX2

(***) Only available for locomotives of the ESU Engineering Edition, only AUX9 and AUX10

Figure 33: Lighting effects for function outputs and the according special functions

Function outputs

Rule 17 Fw	Rule 17 Rev	Dimmer	LED Mode	Spezial function CV 2
4	8	16	128	
4	8	16	128	
			128	
			128	
			128	
			128	
			128	
			128	
			128	
			128	
			128	
			128	
			128	
			128	
			128	
			128	
			128	
			128	
			128	
			128	
			128	
			128	
1 (0 – 31)				Deceleration time (0 – 31) Heating level on Vmax (0 – 31)
				End position „B“ (0 – 63)
				End position „B“ (0 – 63)

Repeat these steps for all 6 function outputs you want to configure.

Example: Double Strobe with LEDs on AUX4.

We want to set up AUX4 to create a Double strobe output. We want to use an LED.

- Using table 32, we find that the Mode Selection CV must be set to 6.
- We find out that for LED compensation mode, we should set the Special function CV to 128.
- We want to have a brightness level of 25.
- Using the table on the left side, we find that the Mode Select CV for AUX4 is 299. We set CV 299 = 4. We also find that the brightness CV is 302 and set it to 25. Finally, the Special function CV for AUX4 is 303 and needs to be set to 128.

- **Mode Select:** Defines which effect you want to have for the output.
- **Switch-on and switch-off delay:** Defines the time by which switch-on and switch-off is delayed.
- **Automatic switch off:** Time after which the output is automatically turned off.
- **Brightness:** Defines the brightness of each individual function output in 32 steps (0 to 31).
- **Special functions CV 1, CV 2:** Defines some further modes for each special effect.
Have a look at the chart figure 33 to see how this works.
The „special function CV 1“ needs to be explained in more detail. The special functions are additional functions you could add to each output.
- **Phase Select:** Alters the timing of the effect so that it is 180 degree out of phase with other effects. This allows you to create alternate blinking.
- **Grade Crossing:** Causes the lighting effect to become active only when the global flag “Grade crossing enable” is set AND

Function outputs

the corresponding function key is ON. Grade crossing logic can be used with any of the light effects. Grade Crossing can be used with most of the lighting effects.

- Rule 17 Forward: Applicable only if the output is set to either “Dimmable headlight” or “Dimmable headlight with fade in / out”. Causes the effect to be dimmed to around 60% of the set brightness, if the locomotive is stopped. When the engine is running forward, the output will be increased to a 100%.
- Rule 17 Reverse: Like Rule 17 Forward, but the brightness will be increased to a 100% when the locomotive drives backwards.
- Dimmer: Causes the output to be dimmed to around 60% of the defined brightness, if the global flag “Dimmer” is set. With this function you are able to realise a full beam very easily by setting the the global function “Dimmer” with a function key (compare chapter 12.2.2.2).

12.3.3. Grade Crossing holding time

You can define the for time the global grade crossing function as you like. By doing so, the “Grade Crossing” will remain active, also after switching off the function key. This will create a very interesting game effect. The desired value will be stored in CV 132. The value of CV 132 multiplied with 0.065 seconds defines the time. The default value 80 results in 5.2 seconds.

12.3.4. Flash Rate

You can also set the flash rate for all lighting effects globally. All effects will flash or strobe at the same rate. The desired value should be stored in CV 112. The value of CV 112 multiplied with 0.065536 seconds (65,536ms) defines the flash rate. The default value 30 results in 1.97 seconds.

12.3.5. Automatic Switch-off

Each output usually switches off when the corresponding key is deactivated. However, sometimes the output has to be “forced” to switch off after a certain period of time to avoid damages.

Digital couplers by ROCO® e.g. cannot handle permanent control. Via the automatic switch-off function you are able to determine

for every output when it should be switched off automatically - no matter if the function key is still activated.

Just write the time, after which the output should be switched off, into the corresponding CV according to the above-mentioned table on page 45. The unit is 0.4 seconds. The default value „0“ deactivates this function.

12.3.6. Switch-on and switch-off delay

You can set switch-on and switch-off delays for each output separately.

- The switch-on delay causes the function to switch on only after the predetermined time has lapsed.
- The switch-off delay causes the function to be turned off only after the predetermined time has elapsed.

Both time periods can be individually set in steps from 0 – 15 and are then written into their common control CV:

Description	Range of values	Time in seconds	Bits within the control CV
Switch-on delay	0-15	0-6,144 seconds	0-3
Switch-off delay	0-15	0-6,144 seconds	4-7

The value to be written into the control CV is established as follows:

Switch-off delay * 16 + switch-on delay

Example: the switch-on delay for AUX3 should be = 13; switch-off delay equals 8, thus $8 * 16 + 13 = 141$ must be written into the Control CV 292.

12.3.7. Digital Couplers

LokSound V4.0

LokSound micro V4.0

LokSound XL V4.0

LokSound V4.0 M4

Some LokSound decoders can directly control digital couplers. Subject to the type of coupler, you must adjust certain settings.

12.3.7.1. „Coupler“ Mode

Krois® and ROCO® couplers need a special high frequency PWM signal to avoid burning the copper windings of the coil. This special function „Coupler“ provides this type of signal. In this mode, the output switches on at 100% for 250 ms and then reduces the output power by switching to the PWM-signal. The ratio between Off and On time can be set by adjusting the „Brightness Value“ from 0 (completely off) to 31 (connected through = 100% output).

This coupler mode should also be used for modern Telex®-couplers.

12.3.7.2. Automatic Coupler Function (Removing/Pushing)

The LokSound V4.0 decoder is able to do the automatic decoupling. When you push the function button the loco drives backwards against the train and then removes from it again. This procedure can be influenced via three CVs.

In [CV 246](#) the speed that moves the loco will be stored (or defined) (0-255). If this value is 0, the automatic coupler function is not active.

In [CV 247](#) the time of removing is to be entered.

In [CV 248](#) the time of pushing is to be entered.

The time of removing should be higher than the time of pushing to make sure that the loco stops in a safe distance away from the train.



The function output of the option „coupler“ needs to be configured correctly to make the automatic decoupling work.

12.3.8. Servo settings

LokSound XL V4.0

You can connect 4 servos to the LokSound XL V4.0, namely in parallel to AUX7 through AUX10.

If you configure these outputs to “Servo” then you should not use the corresponding physical switching output at the terminal strip since it will be continuously set to 100% and cannot be dimmed.

As one can see in the table Fig. 33 one must enter the desired period as a multiple of 0.25 seconds into the “Brightness CV”.

Enter the end position “A” into the “Special function CV 1” and the end position “B” into the “Special function VC 2”.

12.3.8.1. Servo with coupler function

One can also realise an automatic coupler function with a servo. When you set the servo to the coupler mode called “Coupler function with servo” you can adjust the servo running time and the end positions as described above. Furthermore CV 246, CV 247 and CV 248 are active as described in chapter 12.3.7.2.

Function outputs

12.4. Analogue Settings

LokSound V4.0	LokSound micro V4.0	LokSound XL V4.0
LokSound V4.0 M4		

With the CVs 13 and 14, you can predetermine which function buttons should be switched in analogue mode. Thus, you „simulate“ pressing an F button. The ex works default settings switch on the directional headlights (F0 is on!) as well as F1 (ex works allocated to AUX1).

Analog Function Control 1

CV #	F1	F2	F3	F4	F5	F6	F7	F8
13	1	2	4	8	16	32	64	128

Analog Function Control 2

CV #	F0	F9	F10	F11	F12	F13	F15	F15
14	1	2	4	8	16	32	64	128

12.5. LGB® Pulse Sequence Mode

LokSound V4.0	LokSound micro V4.0	LokSound XL V4.0
LokSound V4.0 M4		

It is possible to switch to pulse sequence mode for operations with the LGB® command station and the Roco® Lokmaus I. To do so, set bit 5 in CV 49. From now on decoder counts the number of times the F1 button is pressed in order to activate the desired function. Thus, it is possible to reach all function buttons by repeated pushing of the F1 button.

12.6. Swiss Headlight Mode

LokSound V4.0		LokSound XL V4.0
LokSound V4.0 M4		

Function mapping enables you to set many different configurations. The Swiss headlight mode is a good example. We need a third lighting circuit that switches the left lower headlight of the „A“ - headlight configuration whenever the lights are turned on. This third circuit must work independently from the direction of travel.

Figure 34 shows one option of how to wire this arrangement with AUX1 (green wire) being used for the third circuit. All you have to do now is to program the decoder in such a way that it always switches on that third circuit when the lighting function is active.

In order to do so enter value 5 in CV 330 and value 6 in CV 346. (Don't forget to firstly set the index register CV 31 to value 16 and CV 32 to value 2!). That's it!

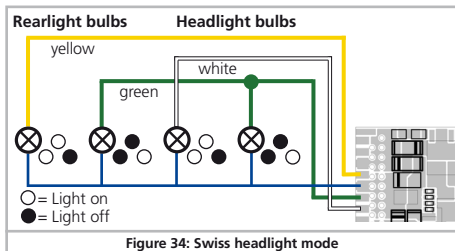

Figure 34: Swiss headlight mode

Adjusting the Sound Effects

13. Adjusting the Sound Effects

The LokSound V4.0 allows you to adjust the sound in a way that suit your preferences for your locomotives. You are able to change the volume of each sound individually, influence the frequency of random sounds or even use an external wheel sensor. Allow yourself some time to adjust your model perfectly!

13.1. Adjust the sound volume

The LokSound V4.0 allows the individual volume control of each sound. Every sound has its own CV.

13.1.1. Adjusting the master volume

Function	Sound slot	CV	Range	Factory default
Master volume		63	0 – 192	180

The master volume control controls all sound effects. A value of „0“ would mute the decoder completely. The resulting sound volume for each individual sound effect therefore is a mixture of the master volume control settings and the individual volume control sliders.

13.1.2. Single sounds tables

All single sounds are subdivided in so-called sound slots. Each sound slot controls a certain sound and its volume can be individually adjusted. The following charts show how the CVs are allocated to each sound slot.



Please note that all the single sound projects are likely to have a different sound allocation. Thus you will find notes about the corresponding functions keys and sound slots to all sound projects available in the download area of our website. This information will help you to find the appropriate CV volume very easily.

Steam sound table

Function	Sound slot	CV	Range	Value
Sound on/off	1	259	0 – 128	99
Sound on/off	2	267	0 – 128	99
Whistle (playable)	3	275	0 – 128	128
Bell	4	283	0 – 128	128
Coal shovelling / Oil burner (AUX2 Firebox)	5	291	0 – 128	128
Air pump	6	299	0 – 128	128
Station announcement #1	7	307	0 – 128	128
Coupler sound	8	315	0 – 128	128
Cylinder blow	9	323	0 – 128	128
Conductor whistle	10	331	0 – 128	128
Sanding valve	11	339	0 – 128	128
Safety valve	12	347	0 – 128	128
Brake Set / Brake Release (automatic)	13	355	0 – 128	128
Drain valve	14	363	0 – 128	128
Curve squeal	15	371	0 – 128	128
Short whistle	16	379	0 – 128	128
Rail joints	17	387	0 – 128	128
Rail joints	18	395	0 – 128	128
	19	403	0 – 128	128
	20	411	0 – 128	128
	21	419	0 – 128	128
	22	427	0 – 128	128
	23	435	0 – 128	128
Boiler noise	24	443	0 – 128	128

Adjusting the Sound Effects

Diesel sound table

Function	Soundslot	CV	Range	Value
Sound on/off	1	259	0 – 128	99
Sound on/off	2	267	0 – 128	99
Signal horn #1 (playable)	3	275	0 – 128	128
Signal horn #2 or bell	4	283	0 – 128	128
Fan motor (AUX 2)	5	291	0 – 128	128
Compressor	6	299	0 – 128	128
Station announcem. #1	7	307	0 – 128	128
Coupler sound	8	315	0 – 128	128
Air outlet valve (Line free)	9	323	0 – 128	128
Conductor whistle	10	331	0 – 128	128
Sanding valve	11	339	0 – 128	128
Close/Open doors	12	347	0 – 128	128
Brake Set / Brake Release (automatic)	13	355	0 – 128	128
Station announcem. #2	14	363	0 – 128	128
Curve squeal	15	371	0 – 128	128
Short whistle	16	379	0 – 128	128
Rail joints	17	387	0 – 128	128
Rail joints	18	395	0 – 128	128
	19	403	0 – 128	128
	20	411	0 – 128	128
	21	419	0 – 128	128
	22	427	0 – 128	128
	23	435	0 – 128	128
	24	443	0 – 128	128

Electric sound table

Function	Soundslot	CV	Range	Value
Sound on/off	1	259	0 – 128	99
Sound on/off	2	267	0 – 128	99
Signal horn #1 (playable)	3	275	0 – 128	128
Signal horn #2 or bell	4	283	0 – 128	128
Fan motor (AUX 2)	5	291	0 – 128	128
Compressor	6	299	0 – 128	128
Station announcem. #1	7	307	0 – 128	128
Coupler sound	8	315	0 – 128	128
Air outlet valve (Line free)	9	323	0 – 128	128
Conductor whistle	10	331	0 – 128	128
Sanding valve	11	339	0 – 128	128
Close/Open doors	12	347	0 – 128	128
Brake Set / Brake Release (automatic)	13	355	0 – 128	128
Station announcem. #2	14	363	0 – 128	128
Curve squeal	15	371	0 – 128	128
Short whistle	16	379	0 – 128	128
Rail joints	17	387	0 – 128	128
Rail joints	18	395	0 – 128	128
	19	403	0 – 128	128
	20	411	0 – 128	128
	21	419	0 – 128	128
	22	427	0 – 128	128
	23	435	0 – 128	128
	24	443	0 – 128	128

Special sound table

Function	Soundslot	CV	Range	Value
Random sounds	-	451	0 – 128	128
Brake sound	-	459	0 – 128	128
Camshaft contactors (for elect. locos)	-	467	0 – 128	128



Before you change any of the volume control CVs, please make sure that the CV 32 is set to 1! As explained earlier, CV 32 is used as an index selection register to distinguish between the real function of CV 257 – 512.

When you adjust the volume levels, please keep in mind that you should not exceed the maximum mixer levels to avoid a condition called “clipping” which occurs when the sum of two or more signals exceeds the capacity of the output channel.

Clipping can be identified by clicking or popping sounds. To avoid this situation, consider which sounds are likely to be played at the same time and take care that their corresponding volume levels are not set too high.

13.2. Prime mover startup delay

Usually, when the LokSound V4.0 sound is idling and you turn up the throttle, the locomotives begins to move only after the Diesel engine has reached notch 1. A steam loco will even release its brakes first and fill the cylinders. Although this behavior is very prototypically, one might not like it because it causes some delay.

You can disable this startup delay by simply deleting bit 3 of CV 124. This will cause the LokSound V4.0 decoder to immediately start moving when the throttle is turned up. However, the start up sound will not be synchron with the motion anymore.

13.3. Manual notching (for Diesel-electric locomotives only)

With Diesel-electric locomotives, the engine revs usually follow the steps of the loco’s speed (typically 8), controlled by the engine electronics. Usually, the LokSound V4.0 decoder automatically selects the diesel speed notch appropriate for the desired speed. However, in some cases where the train has to pull heavy loads, you may want to “shift gears” manually to get higher overall engine RPM.

The LokSound V4.0 offers this feature we call “Manual Diesel notching”. Once you have defined two function buttons one of which activates the “Diesel notch up” and the other “Diesel notch down” then you can adjust the revs of the prime mover in diesel-electric locomotives independently of the speed steps.

- As long as the button “Up” is pressed the revs of the engine are increased step by step. Deactivate this button once the engine has reached the desired revs.
- As long as the button “Down” is pressed the revs of the engine are reduced step by step. Deactivate this button once the engine has reached the desired revs.
- If you want to return to the automatic mode stop the locomotive and press the “Down” button until the engine has reached its idle revs. Then release the “Down” button. When the locomotive moves again it will run in automatic mode.



In some sound projects the manual Diesel notching is already activated ex factory.

Adjusting the Sound Effects

13.4. Synchronising the steam chuff

To synchronise the steam chuff with the wheel revolutions, you may use an external cam as described in chapter 6.9. However, most users prefer not to do such massive changes on their valuable locomotives and prefer to use the automatic exhaust mode of the LokSound V4.0 decoder. Because of the excellent Back-EMF function, the synchronisation will be satisfying most users.

To enable this function (and disable any external cam at the same time), CV 57 and CV 58 are used. All you need is a stop-watch and a little time. It pays to spend some time in order to achieve an optimal result. Please make sure that the load control is perfectly adjusted to your loco and set the maximum / minimum speed according to your wishes. After doing so, you should start to synchronise the steam chuff.

In CV 57, the distance between two steam chuffs at the lowest possible speed (at speed step 1) is defined. The unit of CV 57 is a multiple of 32 ms (Milliseconds). In CV 58, you need to give the LokSound V.40 some information about the gearing of your engine.

Please proceed as follows:

1. Put the engine onto the track and drive it with speed step 1 and switch the sound on.
2. Using the stop-watch, measure the time in seconds it takes the driver to complete one turn at this speed.
3. Divide the time by 0.128 (assuming you are using a 2 cylinder or 4-cylinder locomotive)
4. Enter a rounded value without decimal point in CV 57. We recommend to use POM to be able to observe the result immediately.
5. Observe the locomotive thoroughly and check if there are now produced too many steam chuffs per revolution. If needed, adjust the value of CV 57 gradually by increasing or decreasing the value one by one.

6. If you are satisfied, increase the speed of your locomotive to speed step 4 (of 28).
7. Try to observe, if still four steam chuffs per revolution can be heard. If you find that there are too many steam chuffs, increase the value of CV 58 (defaults to 43). If they are too slow, decrease the value of CV 58. This procedure will adjust the gear factor of the LokSound V4.0 decoder.

13.4.1. Minimum distance of steam chuffs

Quite small driving wheel diameters are likely to make the steam chuffs sound very good at small and medium speeds; however during high speed it sounds strangely distorted and ticked off. This has often to do with an excessive terminal speed that isn't prototypical at all. The minimum distance, which two steam chuffs need to have, can be set with the help of CV 249 to reach a satisfactory sound. A unit of 1 ms allows a quite exact adjustment.

If you are still not satisfied with the sound during high speed, you should increase CV 249 gradually while the sound is switched on, until the sound gets more natural since the steam chuffs are set further apart.

13.5. Random sounds

LokSound decoders offer some random sounds, such as air compressor, air outlet valve, coal shovelling or similar sounds, which makes the scene more realistic. This sound will be played-back in random intervals. You can adjust the "rate" for these sounds.

In CV 61, you need to set the minimum delay between two random sounds. The unit is 0.25 seconds. The default value of 75 results in 18.75 seconds.

In CV 62, you can set the maximum delay between two random sounds. At the end of the programmed time, another random sound will be played. The unit is 0.25 seconds. The default value of 200 results in 50 seconds.

If you don't like random sounds, simply set CV 61 = 0 and CV 62 = 0 to disable this feature.

13.6. Adjusting the braking sound threshold

The LokSound decoder is able to play a wheel-synchron brake sound. To play a brake sound, Damit das Bremsgeräusch abgespielt wird, there are several conditions necessary:

- The braking time in CV 4 is set sufficiently high (at least value 20 or higher).
- The loco drives with high speed at the time of the braking command.
- The loco receives the driving command "Speed step 0".

The LokSound decoder will now start to play the braking sound at the time determined in CV 65. The higher the value in CV 64 is, the sooner the braking sound will be played. The default value 100 is approximately equivalent to speed step 48 of 128.

The braking sound should and when the loco stops. You are able to do some "finetuning" with CV 65, if the loco stops too early.

13.7. Sound fader

The sound fader function enables you to reduce the sound volume by pressing a button. This is useful when entering a tunnel. The required sound volume in the "fader active" mode can be adjusted with CV 133 in relation to the overall volume.

Value 0 – 127:	The volume is lower than normal
Value 128:	The volume is equal to the overall volume (Fader without function)
Value 129 – 255:	Volume is higher than normal

14. Decoder Reset

You can reset decoder to the default settings at any time.

14.1. With DCC Systems or 6020/6021

Enter the value 08 in CV 08.

14.2. With Märklin® systems (mfx® decoders)

Mfx® decoders can be reset to factory default values with the Central Station® or the Mobile Station® via the reset command in the locomotive menu.

14.3. With the ESU LokProgrammer

(From software 2.7.3.): In the menu „Programmer“, select option „Reset decoder“ and follow the instructions on the screen.

15. Special Functions

You may not yet be aware of some other highly specialised functions offered by LokSound decoders.

15.1. Directional Bit

The directional bit determines the driving behaviour when transiting from an analogue into a digital sector (also refer to chapter 10.4.3.). If you want to set this directional bit, then bit 0 in CV 124 must be set.

15.2. Saving the status of functions

LokSound decoders can store the current operational settings. Thus the decoder continues running the locomotive as before after a power interruption, if so desired.

The following data can be stored:

Status of functions:

Store the information regarding which functions were switched on or off and switches them accordingly once power is restored.

Current speed:

If it is stored then the locomotive will continue at this speed after a power interruption disregarding what the command station may transmit.

CV 122 is responsible for this. Storing of the status of functions is turned on with bit 0, speed with bit 1.

16. RailCom®

LokSound V4.0

LokSound micro V4.0

LokSound XL V4.0

LokSound V4.0 M4

RailCom® was developed by Lenz® Elektronik, Giessen, Germany, and is a technology for transmitting information from the decoder back to the command station. Until now DCC systems could only transmit data from the command station to the decoder but could never be sure if the decoder actually received the commands.

The locomotive can send the following information to the command station:

Locomotive address: The decoder transmits its address on request by „Broadcast“. Detectors in a certain track sector can detect this command. Thus, the command station can find out the location of that particular locomotive.

CV information: The decoder can provide feedback about all CV values to the command station per RailCom®. In future, a programming track will not be necessary any more.

Meta data: The decoder can transmit status information such as motor load, current draw of the motor, temperature etc. to the command station.

In order for RailCom® to work all decoders and the command station must be equipped accordingly. LokSound decoders are RailCom®-ready in terms of their hardware. However, it may be necessary to carry out a firmware update in order to activate it.

Prior to use RailCom® must be unlocked by setting bit 3 in CV 29. CV 28 offers further options. Ex works, RailCom® is active in ESU LokSound V4.0 decoders.

16.1. RailCom® Plus

LokSound V4.0 decoders support RailComPlus®, an absolute world novelty developed by Lenz® in collaboration with ESU.

Decoders equipped with RailComPlus® will be automatically recognised by a RailComPlus®-compatible command station. You will never ever have to change the locomotive address of a new locomotive by hand! Just put the locomotive on the tracks and it will be recognised automatically.

Also the name of the locomotive, the functional key symbols as well as the kind of the functions (long-term function and moment function) will be transferred. And all that happens within less seconds, you don't have to wait anymore.

16.1.1. Prerequisites for RailCom® Plus

RailComPlus® implies an accordingly equipped digital command station. The ESU ECoS command station supports RailComPlus®-capable decoders from software 3.4. You don't need to change anything about the decoder settings. It will be automatically recognised.

Of course you can change the locomotive name, all functional key and locomotive symbols and after that write it back on your decoder. This happens automatically in the background.

If you do not wish to have the automatic recognition, you can switch it off by deleting CV 28, bit 7.

17. Firmware Update

You can update LokSound decoders with new operating software (so-called firmware) at any time. This is useful for fixing bugs and implementing new functions.

You can carry out the update yourself for free without having to remove the decoder from the locomotive. All you need is the ESU LokProgrammer. The software of the LokProgrammer will keep your LokSound decoder up-to-date. A separate download is therefore not necessary.

Updates which are carried out by our service department will not be treated as a case of warranty. This service will be charged.

18. Accessories

You will get detailed information regarding accessories at your dealer or on our homepage.

18.1. Switching the Centre pick-up

The circuit board 51966 for switching the centre pick-up only for the decoder with the 21MTC interface is intended for vehicles with two pick-ups. Thus, you can activate the forward pick-up in the direction of movement. This is ideal for block control!

18.2. HAMO Magnets

One cannot drive the universal motors in many Märklin® models directly with a LokSound decoder. Firstly, you must replace the stator coil with a permanent magnet. ESU supplies the following magnets:

51960	Permanent magnet as 220560, for rotor 217450, D=24.5mm, for motor plate 216730, 211990, 228500
51961	Permanent magnet as 220450, for rotor 200680, D=18.0mm, for motor plate 204900
51962	Permanent magnet as 235690, for rotor 231440, D=19.1mm, for motor plate 231350
51965	Permanent magnet for Märklin® 3015, ET800, ST800, Gauge 1, all-current motors.

18.3. Wire Harnesses with 8-pole or 6-pole Socket

If the locomotive you want to convert does not have an interface and you do not want to remove the plug from the decoder then you can use the harness 51950 or 51951: First install the suitable harness and then plug in the decoder.

18.4. Mounting Adapter 21MTC

If you wish to convert a locomotive with a LokSound decoder with the 21MTC interface, the adapter plate 51967 comes in handy: it has a socket for plugging in the LokSound but also has solder points for connecting the original wiring of the locomotive. This is ideal for converting Märklin® locomotives.

With article no. 51968 we offer an adapter board which amplifies both the outputs AUX3 and AUX4 through a transistor and are therefore accessible. Ideal for complex conversions!

19. Support and Assistance

Your model train dealer or hobby shop is your competent partner for all questions regarding your LokSound decoder. In fact he is your competent partner for all questions around model trains.

There are many ways to get in touch with us. For enquiries please use either email, fax (please provide your fax-no. or email address) or go to www.esu.eu/en/forum and we will reply within a few days.

Please call our hotline only in case of complex enquiries that can't be dealt with by email or fax. The hotline is often very busy and you may encounter delays. Rather send an email or fax and also check our website for more information. You will find many hints under "Support / FAQ" and even feedback from other users that may help you with your particular question.

Of course we will always assist you; please contact us at:

USA & Canada (English support), please contact:

Phone: +1 (570) 649-5048
Tuesday & Thursday 9:00am - 3:00pm (CT)
Fax: +1 (866) 591-6440
Email: support@loksound.com
Mail: ESU LLC
477 Knopp Drive
US-PA-17756 Muncy

Germany and all other countries, please contact:

Fax: ++49 (0) 731 - 1 84 78 - 299
Email: www.esu.eu/en/forum
Mail: ESU GmbH & Co. KG
- Technical support -
Edisonallee 29
D-89231 Neu-Ulm
www.esu.eu

20. Technical Data

	LokSound V4.0	LokSound micro V4.0	LokSound V4.0 M4	LokSound XL V4.0
Operation Voltage	5 – 40V	5 – 21V	5 – 40V	5 – 40V
DCC operation using 14/28/128 speed steps, 2-digit and 4-digit addresses; automatic recognition of operational mode	Ok	Ok	Ok	Ok
Motorola®, with 14/28 speed steps, address range for Motorola®-mode	Ok 255	Ok 255	Ok 255	Ok 255
M4-operation with automatic recognition	-	-	Ok	Ok
Selectrix® operation	Ok	Ok	Ok	Ok
Analog DC Operation	Ok	Ok	Ok	Ok
Analog AC Operation	Ok	-	Ok	Ok
DCC programming	Ok	Ok	Ok	Ok
Motorola®-Programming mode using 6021, Mobile Station or Central Station possible	Ok	Ok	Ok	Ok
Mfx® programming procedure	-	-	Ok	Ok
Märklin® brake section	Ok	Ok	Ok	Ok
Brake on DC, Roco® brake section	Ok	Ok	Ok	Ok
Selectrix® brake mode (with diodes)	Ok	Ok	Ok	Ok
Lenz® ABC brake mode	Ok	Ok	Ok	Ok
Shunting mode/Starting brake time switchable		Ok	Ok	Ok
RailCom® Plus	Ok	Ok	Ok	Ok
Continuous motor load	1.1A	0.75A	1.1A	4.0A
5th generation back-EMF control, overload protected	20/40 kHz	20/40 kHz	20/40 kHz	20/40 kHz
Function outputs				
Total load of all function outputs	4/250 mA / 280mA	4/150mA / 280mA	6/250mA / 280mA	12/500mA / 1A
Logic outputs / Bus systems	2 Logic outputs and serial train bus „Susi“ (on 21MTC, PluX)	2 Logic outputs and serial train bus „Susi“ (on Next18 interface)	2 Logic outputs and serial train bus „Susi“ (on 21MTC, PluX)	
Supported function keys	F0 – F28	F0 – F28	F0 – F28 (F0 – F15 M4)	F0 – F28 (F0 – F15 M4)
Integrated PowerPack backup capacitor	-	-	-	Ok
PowerPack optional	Ok	Ok	Ok	-
Audio part	8 sound channels, priority-controlled, 12 Bit dynamic range, 32 MBit flash memory, high-performance audio amplifier «class D», 3W power modes für steam, Diesel, electric sounds			As mentioned left, but duplex audio amplifier, 6.5W each
Dimensions in mm:	30.3 x 15.5 x 5.5	28.0 x 10.0 x 5.0	30.3 x 15.5 x 5.5	51.0 x 40.0 x 14.0

21. List of all supported CVs

21.1. LokSound decoders

On the following pages, we have listed all CVs of LokSound decoders in a chart. Please refer to the CV concept as outlined in chapter 5.1. Please only change CVs if you are certain about their purpose and the impact of your action. Wrong CV settings can lead to impaired performance or may cause your LokSound not to respond at all.

CV	Name	Description	Range	Value
1	Loco address	Address of engine (For LokSound V4.0: Range 1 - 255)	1 - 127	3
2	Start voltage	Sets the minimum speed of the engine	1 - 255	3
3	Acceleration	This value multiplied by 0.25 is the time from stop to maximum speed	0 - 255	32
4	Deceleration	This value multiplied by 0.25 is the time from maximum speed to stop	0 - 255	24
5	Maximum speed	Maximum speed of the engine	0 - 255	64
6	Medium speed	Medium speed of engine	0 - 255	22
7	Version number	Internal software version of decoder	-	-
8	Manufacturer's ID	Manufacturers's ID ESU - Writing value 8 in this CV triggers a reset to factory default values	151	-
13	Analogue mode F1-F8	Status of functions F1 to F8 in analogue mode (see chapter 12.4)	0-255	1
14	Analogue mode FL, F9-F12	Status of function F0, F9 to F12 in analogue mode (see chapter 12.4)	0-63	3
15	Decoder lock	Decoder-Lock Function according to NMRA. For details please see: http://www.nmra.org/standards/DCC/WGpublic/0305051/0305051.html	0 - 255	0
17	Long address of the loco	Long address of engine (see chapter 9.2)	128 - 9999	192
18				
19	Consist Address	Additional address for consist operation. Value 0 or 128 means: consist address is disabled 1 – 127 consist address active, normal direction 129 – 255 consist address active reverse direction	0-255	0
21	Consist Modus F1-F8	Status of functions F1 to F8 in Consist mode Meaning of the bits as in CV 13 (see chapter 12.4)	0-255	0
22	Consist Modus FL, F9-F12	Status of functions FL, F9 to F12 in Consist mode Meaning of the bits as in CV 14 (see chapter 12.4)	0-63	0

List of all supported CVs

CV	Name	Description	Range	Value				
27	Brake mode	Allowed brake modes		28				
		Bit			Function	Value		
		0			ABC braking, voltage higher on the right hand side	1		
		1			ABC braking, voltage higher on the left hand side	2		
		2			ZIMO® HLU brakes active	4		
		3			Brake on DC, if polarity against driving direction	8		
		4			Brake on DC, if polarity like driving direction	16		
		7			Loco brakes with constant brake distance, if FS=0	128		
28	RailCom® Configuration	Settings for RailCom®		131				
		Bit			Function	Value		
		0			Channel 1 Address broadcast enabled	1		
		1			Data transmission allowed on Channel	2		
		7			RailCom® Plus automatic loco recognition active	128		
29	Configuration register	This register contains important information, some of which are only relevant for DCC operation.		12				
		Bit			Function	Value		
		0			Normal direction of travel Reversed direction of travel	0 1		
		1			14 speed steps DCC 28 or 128 speed steps DCC	0 2		
		2			Disable analog operation Enable analog operation	0 4		
		3			Disable RailCom® Enable RailCom®	0 8		
		4			Speed curve through CV 2, 5, 6 Speed curve through CV 67 - 94	0 16		
		5			Short addresses (CV 1) in DCC mode Long addresses (CV 17 + 18) in DCC mode	0 32		
		31			Index register H	Selection page for CV257-512	16	16

List of all supported CVs

CV	Name	Description	Range	Value		
32	Index register L	Selection page for CV257-512	0 - 4	0		
47	Protocol selection	Which protocols are active. Please see chapter 9.5.	0 - 255	13		
		Bit			Function	Value
		0			DCC protocol active	1
		1			M4 protocol active	2
		2			Motorola® protocol active	4
3	Selectrix® protocol active	8				
48	Language selection	Selection of announcement languages for certain sound projects	0 - 15	0		
49	Extended Configuration #1	0	Enable Load control (Back-EMF) Disable Load control (Back-EMF)	1 0	0 - 255	19
		1	DC Motor PWM frequency	0		
			20kHz motor pulse frequency 40 kHz motor pulse frequency	2		
		2	Märklin® Delta Mode	0		
			Disable Märklin® Delta Mode Enable Märklin® Delta Mode	4		
		3	Märklin® 2nd addresses, „low“-Bit	0, 8		
		4	Automatic DCC speed step detection	0		
			Disable DCC speed step detection Enable DCC speed step detection	16		
		5	LGB® function button mode	0		
Disable LGB® function button mode Enable LGB® function button mode	32					
6	Zimo® Manual Function	0				
	Disable Zimo® Manual Function Enable Zimo® Manual Function	64				
7	Märklin® 2nd addresses, „High“-Bit	0, 128				
	Please consider chapter 9.3.1. for explanation of Bit 3, 7					

List of all supported CVs

CV	Name	Description	Range	Value		
50	Analogue mode	Selection of allowed analogue modes	0 - 3	3		
		Bit			Description	Value
		0			AC Analogue Mode (if so, refer to section 7.3.) Disable AC Analog Mode Enable AC Analog Mode	0 1
		1			DC Analogue mode Disable DC Analogue mode Enable DC Analogue Mode	0 2
51	Load control parameter «I» slow	„I“-component of the internal PI-controller for slow driving.	0 - 255	0		
52	Load control parameter «L» slow	„K“-component of the internal PI-controller for lower speed steps.	0 - 255	32		
53	Control Reference voltage	Defines the Back EMF voltage, which the motor should generate at maximum speed. The higher the efficiency of the motor, the higher this value may be set. If the engine does not reach maximum speed, reduce this parameter.	0 - 255	140		
54	Load control parameter „K“	„K“-component of the internal PI-controller. Defines the effect of load control. The higher the value, the stronger the effect of Back EMF control.	0 - 255	50		
55	Load control parameter „I“	„I“-component of the internal PI-controller. Defines the momentum (inertia) of the motor. The higher the momentum of the motor (large flywheel or bigger motor diameter), the higher this value has to be set.	0 - 255	100		
56	Operating range of load control	0 – 100 % Defines up to which speed in % load control will be active. A value of 128 indicates that load control will be switched off after reaching half speed.	1 - 255	255		
57	Steam chuff synchronisation #1	Defines the steam chuff synchronisation. See chapter 12.4.	1 - 255	0		
58	Steam chuff synchronisation #2	Defines the steam chuff synchronisation. See chapter 12.4.	1 - 255	0		
59	Driving sound «min»	Divided by 128 this will yield the value for reproducing the sound at the slowest speed step. Values < 128 are slower, values > 128 are faster than original speed. Meant for «Pitch-Shifting».	1 - 255	128		

List of all supported CVs

CV	Name	Description	Range	Value	
60	Driving sound «max»	Divided by 128 this will yield the value for reproducing the sound at the fastest speed step. Values < 128 are slower, values > 128 are faster than original speed. Meant for «Pitch-Shifting»	1 - 255	128	
61	Random sound «min»	Multiplied by 0.25 it is the time in seconds for the shortest random sound interval. Find more information in chapter 13.5.	0 - 255	120	
62	Random sound «max»	Multiplied by 0.25 it is the time in seconds for the longest random sound interval. Find more information in chapter 13.5.	0 - 255	200	
63	Sound volume «Master»	Master volume for all sounds.	0 - 192	192	
64	Brake sound threshold «Brake On»	If the actual loco speed step is smaller than or equals the value indicated here, the brake sound is triggered. Compare chapter 13.6.	0 - 255	100	
65	Brake sound threshold «Brake Off»	If the actual loco speed step is smaller than the one indicated here (up to 255), the brake sound will be switched off again. Compare chapter 13.6.	0 - 255	25	
66	Forward Trimm	Divided by 128 is the factor used to multiply the motor voltage when driving forward. The value 0 deactivates the trim.	0 - 255	128	
67-94	Speed table	Defines motor voltage for speed steps. The values „in between“ will be interpolated.	0 - 255	-	
95	Reverse Trimm	Divided by 128 is the factor used to multiply the motor voltage when driving backwards. Value 0 deactivates the trim.	0 - 255	128	
112	Blinking light	Blinking frequency of Strobe effects. Always a multiple of 0.065536 seconds.	4 - 64	30	
105	User CV #1	Free CV. Here you are able to save what ever you want.	0 - 255	0	
106	User CV #2	Free CV. Here you are able to save what ever you want.	0 - 255	0	
112	Period of time for blinking effects	Please see chapter 12.3.4.	0 - 255	0	
113	Power Fail Bypass	The time that the decoder bridges via the PowerPack after an interruption of voltage. Unit: A multiple of 0.016384 sec.	0 - 255	50	
122	Status storage	Saves operational status, please see chapter 15.2.		0 - 3 3	
		Bit	Description		Value
		0	Saves the function key status		1
		1	Saves the speed		2
123	ABC Mode „Slow drive“	Speed which is valid in the slow driving section during ABC braking.	0 - 255	100	

List of all supported CVs

CV	Name	Description	Range	Value
124	Extended Configuration #2	Additional important settings for decoders	-	24
		Bit	Description	Value
		0	Bi-directional bit: Enable driving direction when shifting direction. Disable driving direction.	1 0
		1	Disable decoder lock with CV 15 / 16 Enable decoder lock with CV 15 / 16	0 2
		2	Disable prime mover startup delay Enable prime mover startup delay	0 4
		3	Disable serial protocol for C-Sinus Enable serial protocol for C-Sinus	0 8
		4	Adaptive regulation frequency Constant regulation frequency	0 16
		5	Motor safety when blocking. Motor is not switched off when blocked. Motor is switched off for a few seconds when blocked to avoid burnout	0 32
125	Starting voltage Analog DC		0 - 255	30
126	Maximum speed Analog DC		0 - 255	130
127	Starting voltage AC	(not for LokSound micro V4.0)	0 - 255	50
128	Maximum speed Analog AC	(not for LokSound micro V4.0)	0 - 255	150
129	Analogue Function „Hysterese“	Offset voltage for functions in analogue mode. Chapter 10.7.	0 - 255	15
130	Analog Motor „Hysterese“	Offset voltage for motor functions in analogue mode. Chapter 10.7.	0 - 255	5
132	Grade Crossing Hold Time	Grade Crossing holding time. See chapter 12.3.3.	0 - 255	80
133	Sound Fader	Volume when sound fader is active. See chapter 13.7.	0 - 255	128
134	ABC-Mode „Sensibility“	Threshold, from which asymmetry on ABC shall be recognised.	4 - 32	12
246	Automatic decoupling Driving speed	Speed of the loco while decoupling; the higher the value, the faster the loco. Value 0 switches the automatic coupler off. Automatic decoupling is only active if the function output is adjusted to „pulse“ or „coupler“.	0 - 255	0
247	Decoupling - Removing time	This value multiplied with 0.016 defines the time the loco needs for moving away from the train (automatic decoupling).	0 - 255	0

List of all supported CVs

CV	Name	Description	Range	Value
248	Decoupling - Pushing time	This value multiplied with 0.016 defines the time the loco needs for pushing against the train (automatic decoupling).	0 – 255	0
249	Minimum steam chuff distance	Minimum distance of two steam chuffs, independant from sensor data. Compage chapter 13.4.1.	0 – 255	0
250	Secondary steam chuff trigger	Defines the distance between two consecutive steam chuffs for the secondary steam chuff generator. The value indicates the promilles the steam chuff distances of the secondary steam chuff generator ought to be shorter then those of the primary steam chuff generator. It is needed for steam locos with two independent boogies, such as „Big Boy“ or „Mallet“.	0 – 255	0
253	Constant brake mode	Determines the constant brake mode. Only active, if CV254 > 0	0 – 255	0
		Function		
		CV 253 = 0: Decoder stops linearly		
		CV 253 > 0: Decoder stops constantly linear		
254	Constant braking distance forward	A value > 0 determines the way of brake distance it adheres to, independent from speed.	0 – 255	0
255	Constant braking distance backward	Constant braking distances during reverse driving. Only active, if value > 0, otherwise the value of CV 254 is used. Useful for reversible trains.	0 – 255	0

(Page currently without content)

22. Appendix

22.1. Programming Long Addresses

As described in chapter 9.2. the long address is split into two CVs. The byte with the higher value of the address is in CV 17. This byte determines the range in which the extended address will be located. For instance, if you enter the value 192 in CV 17 then the extended address may be between 0 and 255. If 193 is written into CV 17 then the extended address will be between 256 and 511. You can continue this up to addresses with values of 9984 and 10239. The possible values are shown in figure 35.

22.1.1. Write address

To programm a long address you first of all need to calculate the values for CV 17 and CV 18 and then programm it. Please note that it is not possible to programm addresses via the programming mode "POM".

To programm the long address proceed as follows:

- First you determine the desired address, for instance 4007.
- Then you look for the appropriate address range in Fig. 35. The value to be entered into CV 17 can be found in the column on the right. In our example, it is 207.

The value for CV 18 is established as follows:

	desired address	4007
minus	first address in the address range -	3840
	=====	====
equals	value for CV 18	167

- 167 is therefore the value to be entered in CV 18. Thus you decoder is now programmed to address 4007.

22.1.2. Read out address

If you wish to read out a loco address please read the values of CV 17 and CV 18 one after another and proceed then in reverse order: Let's assume you have read:

CV 17 = 196; CV 18 = 147. Look up the corresponding address range in Fig. 23. The first possible address within this range is 1024. Then you have to add the value from CV 18 and you arrive at the locomotive address:

$$\begin{array}{r}
 1024 \\
 + 147 \\
 \hline
 = 1171
 \end{array}$$

Address range			Address range			Address range		
from	to	CV17	from	to	CV17	from	to	CV17
0	255	192	3584	3839	206	7168	7423	220
256	511	193	3840	4095	207	7424	7679	221
512	767	194	4096	4351	208	7680	7935	222
768	1023	195	4352	4607	209	7936	8191	223
1024	1279	196	4608	4863	210	8192	8447	224
1280	1535	197	4864	5119	211	8448	8703	225
1536	1791	198	5120	5375	212	8704	8959	226
1792	2047	199	5376	5631	213	8960	9215	227
2048	2303	200	5632	5887	214	9216	9471	228
2304	2559	201	5888	6143	215	9472	9727	229
2560	2815	202	6144	6399	216	9728	9983	230
2816	3071	203	6400	6655	217	9984	10239	231
3072	3327	204	6656	6911	218			
3328	3583	205	6912	7167	219			

Figure 35: Chart of extended loco addresses

23. Warranty Certificate

24 months warranty form date of purchase

Dear customer,

Congratulations on purchasing this ESU product. This quality product was manufactured applying the most advanced production methods and processes and was subjected to stringent quality checks and tests.

Therefore ESU electronic solutions ulm GmbH & Co. KG grants you a warranty for the purchase of ESU products that far exceeds the national warranty as governed by legislation in your country and beyond the warranty from your authorised ESU dealer. ESU grants an extended

manufacturer's warranty of 24 months from date of purchase.

Warranty conditions:

- This warranty is valid for all ESU products that have been purchased from an authorised dealer.
- No claims will be accepted without proof of purchase. The filled in warranty certificate together with your ESU dealer's receipt serves as proof of purchase. We recommend keeping the warranty certificate together with the receipt.
- In case of claim please fill in the enclosed fault description as detailed and precise as possible and return it with your faulty product.

Extend of warranty / exclusions:

This warranty covers free of charge repair or replacement of the faulty part, provided the failure is demonstrably due to faulty design, manufacturing, material or transport. Please use the appropriate postage stamps when shipping the decoder to ESU. Any further claims are excluded.

The warranty expires:

1. In case of wear and tear due to normal use
2. In case of conversions of ESU - products with parts not approved by the manufacturer.
3. In case of modifications of parts, particularly missing shrink sleeves, or wires directly extended on the decoder.
4. In case of inappropriate use (different to the intended use as specified by the manufacturer).
5. If the instructions as laid down in the user manual by ESU electronic solutions ulm GmbH & Co. KG were not adhere to.

Due to liability reasons any inspections or repairs can only be carried out on products that are not installed in a locomotive or carriage. Any locomotive sent to ESU for inspection will be returned without even touching it. There is no extension of the warranty period due to any repairs or replacements carried out by ESU.

You may submit your warranty claims either at your retailer or by shipping the product in question with the warranty certificate, the receipt of purchase and fault description directly to ESU electronic solutions ulm GmbH & Co. KG:

ESU GmbH & Co. KG
- Garantieabteilung -
Edisonallee 29
D-89231 Neu-Ulm
GERMANY

Trouble shooting sheet

1. Personal data

(Please write in block letters)











Name: _____
Street: _____

ZIP/City: _____ | | | | | |
Country: _____
Email: _____
Phone: _____
Date: _____
Signature: _____

2. Product details and system environment (use extra page if needed)

Art.No.: _____	Purchase Date: _____	Address: _____		
Operation Mode: <input type="checkbox"/> AC Analogue	<input type="checkbox"/> AC Digital	<input type="checkbox"/> DC Analog	<input type="checkbox"/> DC Digital (DCC)	
Digital system: <input type="checkbox"/> ESU ECoS	<input type="checkbox"/> Märklin® 6012	<input type="checkbox"/> ROCO® Digital	<input type="checkbox"/> LGB® Digital	<input type="checkbox"/> LGB® MZS
<input type="checkbox"/> Intellibox®	<input type="checkbox"/> Lenz® Digital	<input type="checkbox"/> Others:		

3. Error description

<input type="checkbox"/> Headlight output front 	<input type="checkbox"/> No Sound 	<input type="checkbox"/> Cable 
<input type="checkbox"/> Headlight output rear 	<input type="checkbox"/> Wrong Sound 	<input type="checkbox"/> Change direction probl 
<input type="checkbox"/> Motor output 	<input type="checkbox"/> Short circuit 	<input type="checkbox"/> Without any function (DOA)
<input type="checkbox"/> Programming 	<input type="checkbox"/> AUX output 	<input type="checkbox"/> Other problems: _____

4. Receipt - Proof of purchase (Please enclose this document!)

Please enclose your receipt / invoice. Otherwise no warranty possible!

5. Additional information:

6. Your retailer:

Retailer's stamp or address

