

Power Pro System Reference Manual

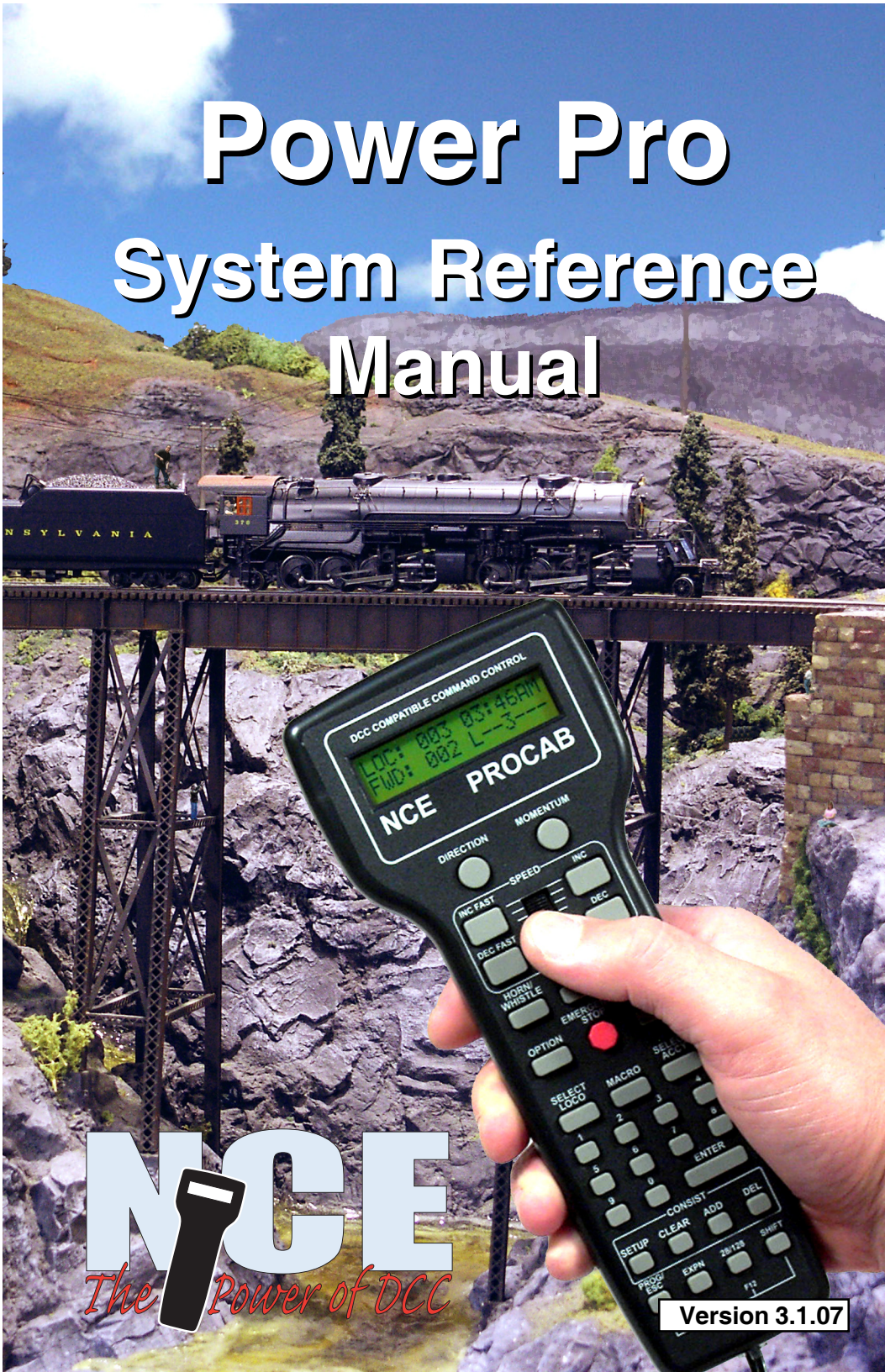

NCE
The Power of DCC

Version 3.1.07

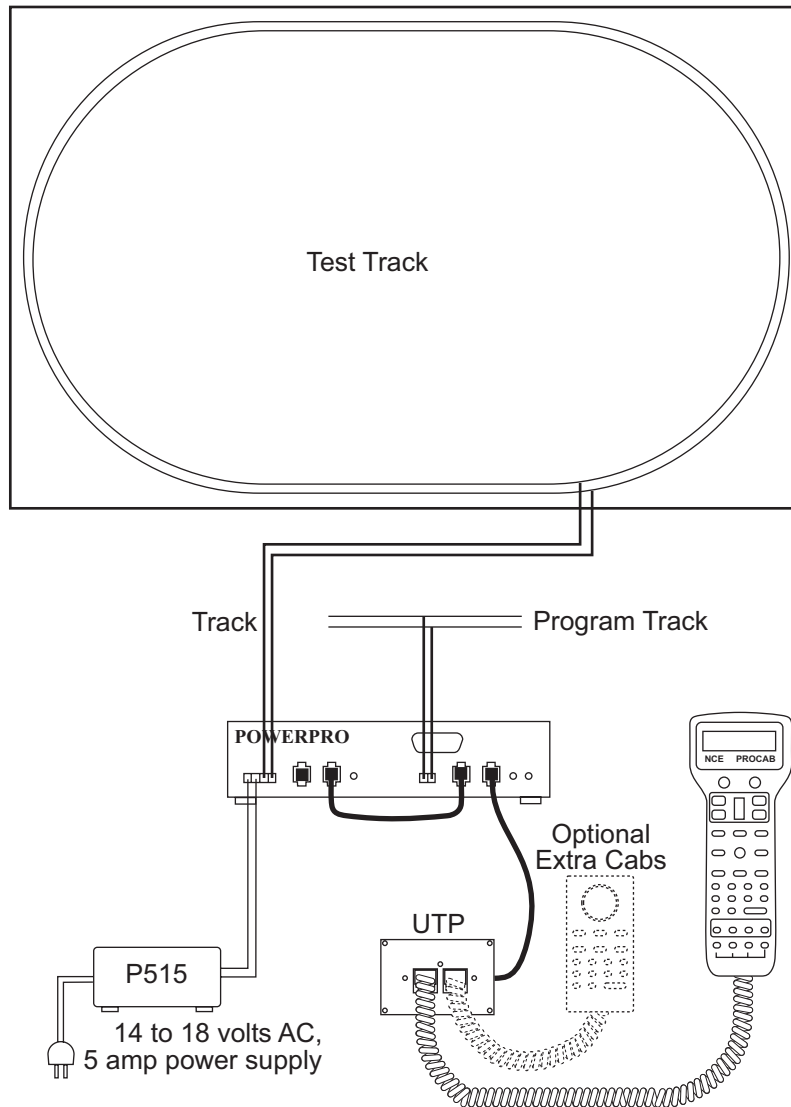

Basic Set Up of 5 Amp Power Pro System

BE CAREFUL

An NCE P515 power supply (15VAC - 5AMP) is the preferred transformer for your system. If you are using a different transformer be sure to measure the actual no load voltage before connecting it to your system. Many 16 Volt transformers put out 19 to 20 Volts with no load. If you have a transformer that puts out more than 18 Volts do not use it. The maximum input voltage to your Power Pro or PB105 is **18 Volts AC**. Voltages higher than 18 Volts AC will ultimately destroy your booster resulting in an expensive repair charge.

Quick Start

Contents of the 5 Amp Power Pro System:

Power Pro System Box with 4 pin and 2 pin plugs
Pro Cab
Seven foot coiled cable
Twelve inch flat cable
UTP cab bus panel
Power Pro system reference manual

We recommend that you follow the instructions below to connect your system to a small test track first. After your system is checked out completely and known to be working then consider the final installation locations for components and connections to the track.

TRYING OUT YOUR POWER PRO:

- #1 Disconnect the existing power supplies from your layout.
- #2 Connect the long (7 foot) coiled cable from the cab into the Power Pro CAB BUS socket.
- #3 Plug one end of the short (1 foot) cable into the Power Pro CONTROL BUS socket that is next to the CAB BUS socket. The other end of this wire plugs into either one of the remaining CONTROL BUS sockets. This connects the "Command Station" portion of the Power Pro to the "Power Booster" portion.
- #4 If in place, pull the 4 pin plug from its socket on the face of the Power Pro. Connect your power source to the screw terminals marked POWER. Your power source must have a voltage output within the range of 12-18 volts AC or 18-28 volts DC. Do not exceed these voltages as damage to the Power Pro is certain to result. If there is not enough voltage (under about 12VDC) the left hand STATUS light on the Power Pro will flash quickly. There will be a similar indication if the DCC signal from the command station is lost. The Power Pro is factory adjusted to put out the NMRA recommended 14.25 volts for N, HO and S scales..
- #5 Set up a test track. Obtain a length or two of flex track, or better yet, use that old circle of Atlas Snap Track you've had kicking around for years. Do NOT connect the Power Pro up to your layout at this time. We want you to test the operation of your new DCC system without the complication of troubleshooting any layout wiring, closed gaps, broken switch points, etc. Once you are confident that your new Power Pro DCC system is up and running as advertised then hook it up to the layout (after finishing the Quick Start Guide). Make sure that your layout wiring can stand a continuous 5 Amps of current. We recommend a minimum of #16 feeder bus, preferably #14 and at least #22 AWG power drops from the rails to the feeder bus. If you have a locomotive with a DCC decoder already installed connect two wires from your test track to the TRACK screw terminals of the Power Pro. Plug this connector into the Left socket.
- #6 Carefully inspect all wiring to make sure proper connections have been made. Do not permit unused decoder wires to touch each other. A piece of tape will help here.
- #7 Plug in the power source and/or turn on the power.
- #8 The display of the cab should look something like:

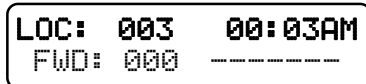

```
LOC: 003 00:03AM
FWD: 000 -----
```

This is what we call the 'NORMAL DISPLAY'. The fast clock in the upper right hand corner will most likely show a different time.

The following cab buttons must be pressed in the proper sequence to acquire control of the locomotive #3 (in the above example locomotive #3 is already selected):

- a. Press **SELECT LOCO** button once.
- b. Press the "3" button once. DO NOT press 0 then 3.
- c. Press **ENTER**.

Note: By convention, all locomotive decoders have their short address set to 3 at the factory.

TIP #1 ➔ If you make a mistake while entering numbers on the cab just keep pressing more numbers until the number entry field clears, then enter the correct numbers.

TIP #2 ➔ Whenever the cab is waiting for you to enter data (a flashing black square is on the screen at the point where the numbers will go) you can press the **PROG/ESC** key to "escape" what you were doing and return to normal operation mode.

TIP #3 ➔ Whenever you have pressed a button (such as **SELECT LOCO**) and you want to keep what ever number that is already on the screen just press **ENTER**.

#9 To operate the locomotive, the following controls are used:

- a. The thumbwheel will increase/decrease speed. The speed control buttons that flank the thumbwheel on either side may also be used as desired to control the loco speed.
- b. Pressing the **DIRECTION** button will cause the loco direction to reverse.

CONGRATULATIONS! You are now operating one locomotive with DCC control. In most cases, less than twenty minutes has elapsed since you started reading this Quick Start Guide.

After completing your Quick Start, go to Page 8 - "Completing the Quick Start."

Basic Set Up of 10 Amp Power Pro System

Note: The power wiring to the PB110 and the CS02 Command Station are **DIFFERENT**. If not wired correctly, serious damage and a costly repair may occur.

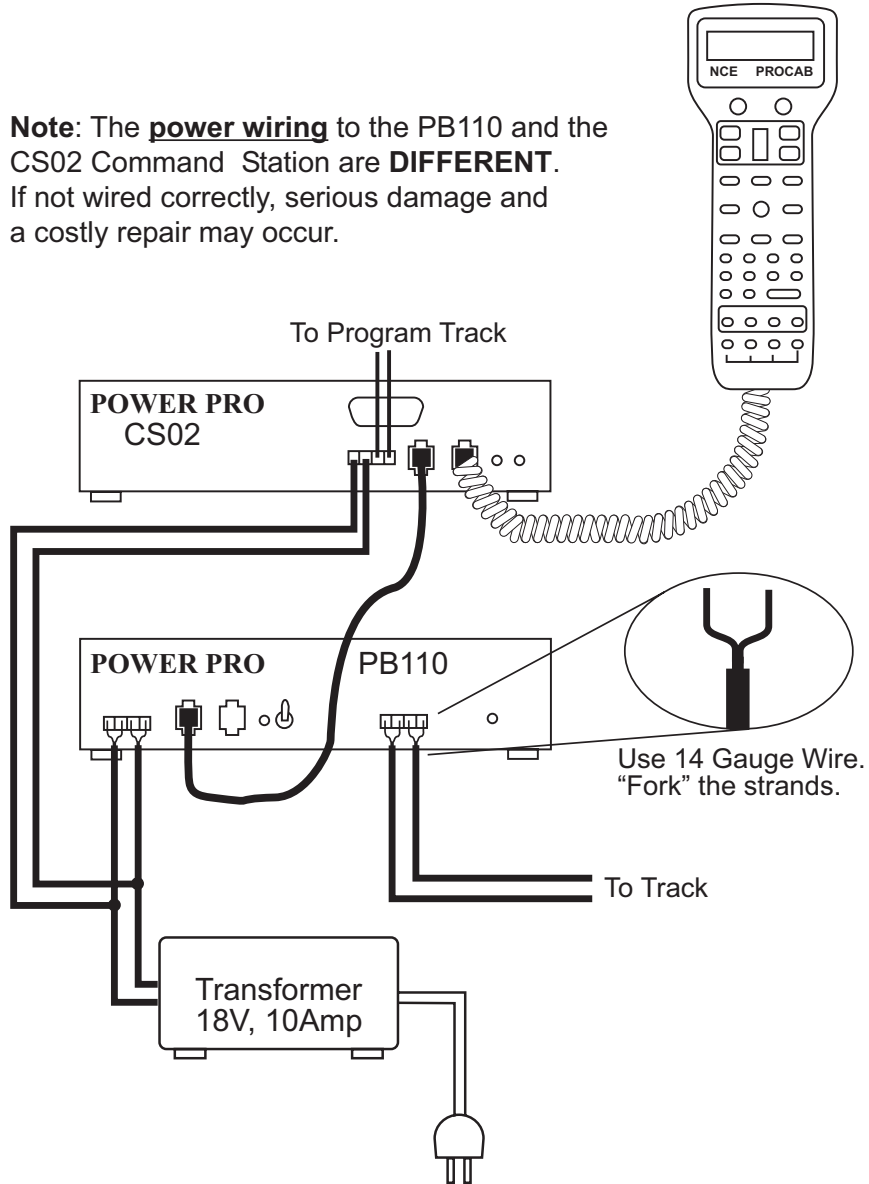

Basic Set Up of 10 Amp Power Pro System

BE CAREFUL

The maximum input voltage to your PH-10 or PH-10R is **22 Volts AC**. Voltages higher than 22 Volts AC will ultimately destroy your booster resulting in an expensive repair charge.

We recommend our 18V AC, 10 Amp transformer (P.N. 524-224, P1018). If you are using a different transformer be sure to measure the actual no load voltage before connecting it to your system.

Quick Start

Contents of the 10 Amp PH-10 System:

CS02 Command Station

PB110A Booster

Pro Cab

Seven foot coiled cable

Twelve inch, four wire flat cable

Seven foot, four wire flat cable

UTP cab bus panel

Seven foot, six wire flat cable for the UTP panel

Power Pro system reference manual

We recommend that you follow the instructions below to connect your system to a small test track first. After your system is checked out completely and known to be working then consider the final installation locations for components and connections to the track.

TRYING OUT YOUR PH-10:

- #1 Disconnect the existing power supplies from your layout.
- #2 Connect one end of the long (7 foot) **coiled** cable from the cab into the CS02 CAB BUS socket. Plug the other end in the ProCab.
- #3 We supply a twelve inch and a seven foot four wire, **flat** cable for the CONTROL BUS. Depending on where you mount the CS02 and the PB110A, use either the short or long cable. Plug one end of the cable into the CS02 CONTROL BUS socket. The other end of this cable plugs into one of the CONTROL BUS sockets of the PB110A. This connects the "Command Station" portion of the Power Pro to the "Power Booster" portion.
- #4 If in place, pull the 4 pin plug from its socket on the face of the Power Pro. Connect your power source to the screw terminals marked POWER. Your power source must have a voltage within the range of 16-22 volts AC. Follow the diagram to the left. Make special note of the differences between the CS02 power and the PB110A power wiring. Do not exceed these voltages as damage to the PB110A is certain to result. If there is not enough voltage, the STATUS light on the PB110A will flash quickly. There will be a similar indication if the DCC signal from the command station is lost. The PB110A is factory adjusted to put out the NMRA recommended 16 volts for O and Large Scale.

NOTE: Hook up to the PB110A and the CS02 are different.

- #5 Set up a test track. Obtain a length or two of flex track, or better yet, use that old circle of Atlas Snap Track you've had kicking around for years. Do NOT connect the PH-10 up to your layout at this time. We want you to test the operation of your new DCC system without the complication of troubleshooting any layout wiring, closed gaps, broken switch points, etc. Once you are confident that your new PH-10 DCC system is up and running then hook it up to the layout (after finishing the Quick Start Guide). Make sure that your layout wiring can stand a continuous 10 Amps of current. We recommend a minimum of #14 feeder bus, preferably #12 and at least #18 AWG power drops from the rails to the feeder bus.
Connect two wires from your test track to the TRACK screw terminals of the PH-10 plug. Plug in this connector into the socket marked TRACK.
- #6 Carefully inspect all wiring to make sure proper connections have been made.
- #7 Plug in the power source and/or turn on the power.
- #8 The display of the cab should look something like:

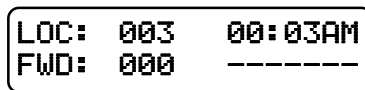

This is what we call the 'NORMAL DISPLAY'. The fast clock in the upper right hand corner will most likely show a different time.

The following cab buttons must be pressed in the proper sequence to acquire control of locomotive #3 (in the above example locomotive #3 is already selected):

- a. Press **SELECT LOCO** button once.
- b. Press the "3" button once. DO NOT press 0 then 3.
- c. Press **ENTER**.

Note: By convention, all locomotive decoders have their short address set to 3 at the factory.

- TIP #1** ➔ If you make a mistake while entering numbers on the cab just keep pressing more numbers until the number entry field clears, then enter the correct numbers.
- TIP #2** ➔ Whenever the cab is waiting for you to enter data (a flashing black square is on the screen at the point where the numbers will go) you can press the **PROG/ESC** key to "escape" what you were doing and return to normal operation mode.
- TIP #3** ➔ Whenever you have pressed a button (such as **SELECT LOCO**) and you want to keep what ever number that is already on the screen just press **ENTER**.
- #9 To operate the locomotive, the following controls are used:
 - a. The thumbwheel will increase/decrease speed. The speed control buttons that flank the thumbwheel on either side may also be used as desired to control the loco speed.
 - b. Pressing the **DIRECTION** button will cause the loco direction to reverse.

CONGRATULATIONS! You are now operating one locomotive with DCC control. In most cases, less than twenty minutes has elapsed since you started reading this Quick Start Guide.

After completing your Quick Start, go to Page 8 - "Completing the Quick Start."

COMPLETING THE QUICK START

Operating one locomotive is fun — for awhile. But operating two or three locomotives is a lot more fun for a much longer time. Advancing beyond this simple DCC testing requires decoder installation into more locomotives and perhaps a few straight pieces added to your circle of track. After you have at least two locomotives with decoders we can continue with two locomotives simultaneously operating under DCC control. To accomplish this, both decoders need to be installed in their respective locomotives and at least one decoder will need to be programmed with a different address.

PROGRAMMING A LOCOMOTIVE ADDRESS

#1 The first item of business in this section is to connect a programming track. We simply use an old piece of snap track connected to the PROGRAMMING TRACK terminals of the system box.

#2 Place a locomotive with an installed decoder on the programming track.

#3 Press the **PROG** button four times to get to the programming track menu.

Your cab should read:

```
SELMODE xx:xxPM
USE PROGRAM TRK
```

xx:xx represents the fast clock which may display any time at this point.

#4 Press **ENTER** to use the programming track and you will see:

```
PROG TRK xx:xxPM
1=STD 2=CV 3=REG
```

NOTE: The STATUS light of the booster will flash rapidly indicating that the power booster portion of the system has turned off track power. This is due to a loss of DCC signal from the command station half of the Power Pro and is normal when using the programming track.

#5 Press “1” to use Standard programming. You will see:

```
MAIN OFF xx:xxPM
MANUFACTURER: ___
```

After a moment the blank space after MANUFACTURER: will be filled in with “011” which is the NMRA code for NCE Corporation. All manufacturers have different codes.

If you get a CAN NOT READ CV message the decoder is not responding. Check the locomotive, decoder and programming track wiring. An older decoder that uses “paged” mode (discussed later) can take up to 15 seconds to read the values.

#6 Press **ENTER** read the version of the decoder version (this will vary depending upon which model decoders were shipped with your system).

#7 Press **ENTER** again to see:

Press **1** to set up the address.

```
ACTIVE ADR:SHORT
SETUP ADR  1=YES
```

By convention all DCC locomotive decoders are set to short address #3 at the factory. If your decoder has not had its address changed you will see a short address as the active address.

```
ACTIVE ADR:SHORT
SHORT ADR:   003
```

TIP A decoder can have 2 different addresses, the Short Address (values from 1-127) or the Long Address (sometimes called 4 digit with a range of 0000-9999). A decoder can use one or the other but not both at the same time. Some entry level decoders can only use the Short Address.

#8 Press **ENTER** to keep the current short address set to 3.

#9 Press **ENTER** again to skip activating the short address.

#10 Next you will see the Long Address (which is probably set to 0000 or sometimes to 9999). With older decoders, it may take a up to 30 seconds to read the long address.

This is the address we will change.

#11 You will likely want to enter the number on the side of the locomotive cab as the Long Address. Type in the number of the locomotive and press **ENTER**.

#12 Press **1** to activate the Long Address.

You have just changed the Long Address.

At this point, press **PROG/ESC** twice to exit the program track mode.

You have just completed the hardest part of DCC... programming the locomotive on the programming track.

By now the left status light of the booster will be glowing steadily indicating that track power has been restored. ***Put your freshly programmed locomotive back on the test track, it won't run on the programming track.***

To select the locomotive:

- a. Press **SELECT LOCO** button
- b. Press the digits corresponding to the Long Address you just programmed..
- c. Press **ENTER**

At this point you should have control of the locomotive. Now is the time to program up a second locomotive and run them both.

RUNNING TWO LOCOMOTIVES WITH ONE CAB

#1 Select the first locomotive you wish to run (**SELECT LOCO** followed by address then **ENTER**).

#2 Press **RECALL** to store this locomotive in one of the internal recall "slots" of the cab. The display of the cab will now show a locomotive of 000.

#3 Select the second locomotive and start running it.

#4 By pressing **RECALL** you can toggle back and forth between the two different locomotives. At any time you can select a new locomotive "over the top" of any locomotive already on the display. The existing locomotive will be forgotten by the cab with the new one taking it's place. The one in **RECALL** will remain available for recall.

Power Pro™

~ The Finest in Digital Command Control ~

System Reference Manual

for Power Pro 5 Amp Systems

and

PH-10 10 Amp Systems

Rev. 03.01.07

NCE Corporation

899 Ridge Road
Webster, NY 14580
(585) 671-0370

Copyright 1994 - 2007

CUSTOMER SERVICE

Customer Service is handled through our factory warranty center or by your dealer. It is faster to deal direct with the factory. Please write or call us before returning any products to our warranty center. Sometimes the problem is easily solved over the phone. If writing make sure you include your name, address and phone number and the times that you can be reached at that number. This will greatly expedite our service to you if you have questions.

NCE Warranty Center
899 Ridge Road
Webster, NY 14580

Please check our web site: www.ncedcc.com to ensure that you have our latest address.

Phone: (585) 671-0370
Fax: (585) 671-9337

Email Address: support@ncecorporation.com
Web Site: www.ncedcc.com

We reserve the right to either repair or replace components sent to us for in-warranty service.

The warranty period will begin on the date shown on your retail sales receipt. Please do not send anything for repair without first writing or calling to explain the problem. Also remember to include your name, address and phone number with a brief description of the problem.

REGISTER MY SYSTEM... WHY?

By registering your Power Pro DCC system with us you will receive personal notification of any software and hardware updates. At various times we provide free updates to our customers. At other times there is a nominal charge to cover shipping and handling (usually about \$5). We do NOT use your name or address for any purpose other than upgrade notification. We will not sell or otherwise provide your personal information to any other person, company or entity.

ABOUT THIS MANUAL

This manual covers the installation and operation of the NCE Power Pro 5 Amp and 10 Amp DCC systems. It is not a comprehensive tutorial on all the aspects of Digital Command Control. It is not necessary to know the inner workings of DCC to use this system. Some users may wish to delve deeper into the how and why of Digital Command Control for model railroads, especially those wishing to use the computer interface of the Power Pro. For those interested in the "nuts and bolts" we recommend the reading of the following NMRA Standards and Recommended Practices as they pertain to DCC. Applicable standards are: S-9, S9.1 and S-9.2 and Recommended Practices: RP-9.1.1 through RP-9.2.4. These documents are available via the Internet at www.nmra.org.

Editorial help has been provided by Lou Nost of Penfield, New York. The NCE Publications Department wrote this manual. Please address comments regarding the manual to:

NCE Publications Dept.
899 Ridge Road
Webster, NY 14580
Support@ncecorporation.com

TABLE OF CONTENTS

COMPLETING THE QUICK START	8
PROGRAMMING A LOCOMOTIVE ADDRESS	8
RUNNING TWO LOCOMOTIVES WITH ONE CAB	9
CUSTOMER SERVICE	11
REGISTER MY SYSTEM... WHY?	11
INSTALLING DECODERS	14
PRECAUTIONARY NOTES FOR DECODERS	15
GENERAL SYSTEM INSTALLATION	16
DEVICE LOCATIONS	16
PROGRAMMING TRACK	16
REVERSE BLOCKS, WYES, AND CROSSOVERS	17
WIRING	17
SYSTEM EQUIPMENT DESCRIPTIONS	18
THE POWER PRO™ SYSTEM UNIT	18
POWER PRO™ PH-10 SYSTEM UNIT	18
THE COMMAND STATION	19
COMMAND STATION CONNECTIONS AND INDICATORS	19
COMPUTER INTERFACE PORT	19
CONTROL BUS SOCKETS	19
STATUS LIGHT	19
SYSTEM SPECIFICATIONS	19
REPLACING THE EPROM IN YOUR POWER PRO:	20
BATTERY CONNECT JUMPER	20
POWER BOOSTER	21
CONNECTIONS, CONTROLS AND INDICATORS	21
TRACK VOLTAGE ADJUSTMENT - PB105	22
TRACK VOLTAGE ADJUSTMENT - PB110A	23
USING MULTIPLE BOOSTERS ON YOUR LAYOUT	23
DOUBLE GAPPED LAYOUTS	23
COMMON RAIL LAYOUTS	23
CONNECTION TO AUTOMATIC REVERSING MODULES	23
THE PROCAB™	24
THE LCD SCREEN	25
LOCOMOTIVE CONTROL AREA	25
COMMONLY USED BUTTONS	26
LOCO AND ACCESSORY SELECTION GROUP	27
DATA ENTRY/FUNCTION CONTROL	27
CONSIST SETUP GROUP	27
PROGRAMMING AND EXTENDED FUNCTION CONTROL	28
CAB SETUP	29
PRO CAB SPECIFICATIONS	30
CAB BUTTON NUMBERING SCHEME	31
TABLE OF FACTORY DEFAULT VALUES	32
6 WIRE CAB BUS CABLE WITH RJ-12 CONNECTORS	32
OPERATING PROCEDURES	33
THE "NORMAL" DISPLAY	33
SELECTING A LOCOMOTIVE OR CONSIST	33
CONTROLLING HEADLIGHTS AND OTHER DECODER FUNCTIONS	34
CONSISTS - OLD AND ADVANCED CONSISTS EXPLAINED	35
ADVANCED CONSISTS	35
OLD STYLE CONSISTS (ALSO CALLED BRUTE FORCE OR UNIVERSAL)	35
SETTING UP AN ADVANCED CONSIST	35
DROPPING A LOCOMOTIVE FROM AN ADVANCED CONSIST	37
ADDING A LOCO TO AN ADVANCED CONSIST	37
CLEARING AN ADVANCED CONSIST	38
CHANGING THE LEAD/REAR LOCO	38

OLD STYLE CONSISTS	39
SETUP AN OLD STYLE CONSIST	39
ADDING A LOCO TO AN OLD STYLE CONSIST	40
DROPPING A LOCO FROM AN OLD STYLE CONSIST	40
CLEARING AN OLD STYLE CONSIST	41
CONTROLLING TURNOUTS AND OTHER ACCESSORIES	42
MOMENTUM BUTTON	43
USING MACROS TO CONTROL TURNOUTS	44
MACROS EXPLAINED	44
PROGRAMMING PROCEDURES	45
ACCESSING PROGRAMMING MODES	45
PROGRAMMING MENUS TABLE OF CONTENTS	46
PROGRAMMING ON THE MAIN	48
ASSIGNING A LOCO TO A CAB	55
SET THE SYSTEM CLOCK	56
USE PROGRAM TRACK	57
SETUP COMMAND STATION	66
SETTING THE CAB PARAMETERS	72
PROGRAM ACCESSORY DECODERS ON THE MAIN	74
PROGRAM MACROS	75
BROWSE CONSISTS	77
PROGRAM SIGNAL DECODERS	78
PLAYABLE WHISTLE OR HORN	79
RS232 SERIAL COMPUTER INTERFACE	80
CABLE	80
BINARY COMMAND SET (RECOMMENDED)	81
HELPFUL HINTS	85
TROUBLE SHOOTING	86
COPYRIGHTS	87
WARRANTY	87
FCC STATEMENT	88
ABOUT NCE	88
ADVANCED LAYOUT WIRING	90
MENU NAVIGATION CHARTS	92

INSTALLING DECODERS

Read the following section on decoders before starting. There are shortcuts to temporary installations of the other components, but do not shortcut the decoder. We recommend you get your first decoder installed by a dealer or locomotive manufacturer just so you have a good example of how it's done.

The most important part of a successful decoder installation is proper isolation of both motor brushes from the track so that they are driven only by the decoder. Failure to isolate will definitely damage the decoder. Damage caused by failure to isolate the motor is not covered by the guarantee or warranty.

We find it preferable to mount the decoder with 1/2" wide 3M photo-mount double sided foam tape (we get ours at the local supermarket).

Before test running your newly converted locomotive on full power double check your wiring to make sure the motor is fully isolated and that there are no pinched or broken wires. We see many decoders returned due to wires getting pinched between the body shell and frame causing shorts.

Due to the high in-rush current of incandescent grain-of-wheat type bulbs (about 10 times the normal operating current) we have rated the decoder function outputs at 100mA each. We recommend Miniatronics part number 18-014-10 (2.4mm diameter 14 volt/30mA) bulbs for good results. If you are running higher voltages you will need to use 16 or 18 volt bulbs.

If you need to use higher current lamps (50-150mA) we recommend a 22 ohm 1/4 Watt resistor in series with each bulb (this will also greatly extend bulb life). The function outputs are rated at 150mA continuous if used with LEDs or other low in-rush devices. **Always make sure the motor is isolated from the frame.** Always make sure metal couplers are isolated from the frame.

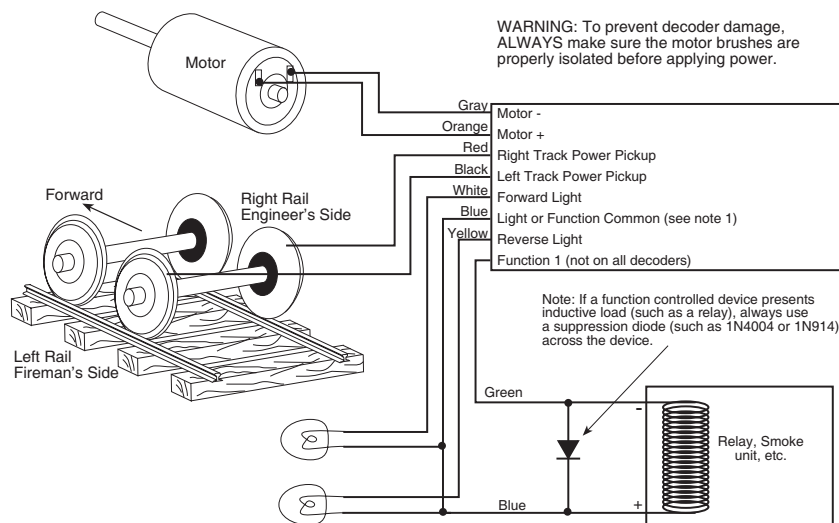

Note 1: The function common (blue wire) is the positive lead providing rectified DC voltage. If you elect to NOT use the common, power the light or other device from either track power pickup for "half-wave" operation (approx. 1/2 voltage).

PRECAUTIONARY NOTES FOR DECODERS

- MAKE SURE NO METAL PART OF THE LOCOMOTIVE TOUCHES ANY METAL PART OF THE DECODER. APPLY ELECTRICAL TAPE TO THE INTERIOR OF THE LOCO AT ANY QUESTIONABLE POINTS.
- THERE MUST BE NO ELECTRICAL CONNECTION BETWEEN THE MOTOR AND THE RAILS. BOTH MOTOR TERMINALS MUST BE ELECTRICALLY ISOLATED FROM THE MOTOR FRAME AND BODY.
- IF YOU USE METAL COUPLERS MAKE SURE THE COUPLERS ARE INSULATED FROM THE FRAME. THIS CAN CAUSE MYSTERIOUS PROBLEMS WHEN RUNNING TWO OR MORE LOCOMOTIVES COUPLED TOGETHER.
- DO NOT USE CONVENTIONAL (older) DECODERS WITH CORELESS MOTORS.
All NCE decoders are high frequency motor drive decoders. These will not harm coreless motors.
- Test the locomotive to assure good analog operation. Poor running locomotives will not run well with DCC either. Test the loco under a "stalled" condition. First connect ammeter between the DC power supply and the track. Remove the loco's shell. Increase power to the loco until it reaches at least 12 Volts. Now stall the motor by squeezing the flywheel until it stops. With locomotives without flywheels, push down on the mechanism until the wheels stop turning. Note the reading on the meter. The decoder rating needs to exceed the highest amperage reading otherwise the decoder will cause the loco to have intermittent stops when operating at the decoders' rated amperage.
- We suggest installing the wiring harnesses with plugs for all leads being used in order to facilitate decoder removal in the future.
- Lights and motor stall current should not exceed the values listed for each decoder. Nor should their total exceed the amount of current remaining after testing the loco motor "stalled". The Function common (blue wire), is track voltage.
- Make a wiring diagram of your locomotive's motor power and lighting. Copy it and add how you are going to insulate the motor from the frame, if it is not already insulated, and where you are going to cut the wires from the track pickups to the motor and lights. LGB locomotives can be tricky here.
- The power for the Functions normally is connected to the Blue wire. This will supply the lights with 14-15 volts (for the NORMAL setting). If you connect the lighting common to one of the rails (Red or Black), the voltage to the lights will be cut to half (7 - 8 volts) the common voltage.
- Place the loco on the programming track and refer to the section "PROGRAMMING ON THE PROGRAMMING TRACK". Almost all decoders come from the factory with the address "3".

When wiring, the right hand rail is the rail to the right of the observer standing between the rails with their back to the front of the locomotive, also referred to as the "engineers side". For traction systems, the overhead wire is considered the right hand rail.

GENERAL SYSTEM INSTALLATION

DEVICE LOCATIONS

The physical locations for the Power Pro can be anywhere. We *suggest* a location where the LED's on the front can be easily seen should there be a problem. Cab Bus panels such as the UTP or UTP-DIN are set up to use prewired six wire RJ12 telephone type cables to connect from panel to panel behind the layout fascia. Page 25 has a diagram of the proper wiring for these cables. We recommend using 7 foot cables to connect from one panel to the next. In yard areas closer spacing may be needed. We suggest that a plug be no more than three feet from any siding where an operator would most likely stop and spend some time. Consider that operators will tend to gather at these panels so placement in crowded aisles may require care.

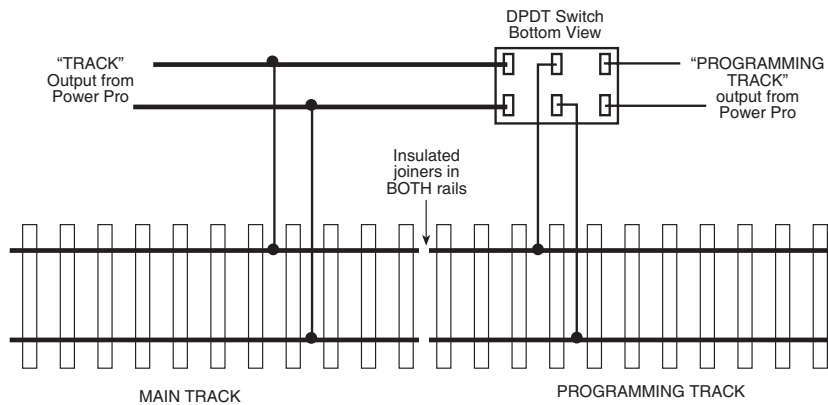

PROGRAMMING TRACK

The programming track is a separate section of track where programming (setting the locomotive address and/or other internal parameters) takes place. The programming track must be electrically separate from the main trackage. The end of a convenient spur track will work fine. Install insulated joiners in both rails, directly across the track from each other. Allow enough length for your longest locomotive. **NOTE: The programming track can not supply enough power to run a locomotive.**

If desired, the programming track can be connected with a double-pole double-throw switch that is used to isolate this segment from the rest of your layout. This track is needed to complete the necessary start up programming for most decoder-equipped locos.

When using the programming track, the remainder of the layout is stopped. With NCE decoders, all parameters can be changed on the mainline using the "Programming on the Main" feature, without shutting down the whole layout. Many other manufacturer's decoders do not support "Programming on the Main" so a programming track is required. Some owners have setup their shop loop to be DC, DCC, and programming track, then they can do all the testing in their shop and have only ready-to-run loco's on the layout.

REVERSE BLOCKS, WYES, AND CROSSOVERS

Reversing loops/sections still present the same potential for short circuits as conventional DC layouts. You can use commercial auto-reverse loop modules such as the MRC AD520 or Tony's Trains Auto Reverser. See the PB-105 manual or the PB-105 section of this manual for installation notes. The tail track of a wye (if it doesn't connect to any other trackage) can simply be wired through DPDT reversing contacts on the switch machine used to throw the switch that controls the tail track.

WIRING

If you already have a layout, your existing wiring most likely can be used without problems as long as it can handle a continuous 5 amp current. We suggest a "bus" of two large gauge (12-14 AWG) wires that follow the general track route of your layout with feeder wires to the track about every 3-6 feet. For the most trouble free operation we suggest a feeder to EVERY piece of rail. Don't rely on the rail joiners to handle 5 Amps of current. To prevent voltage drop over long runs a chart of recommended wire sizes is found below.

For the hobbyist wiring up a new layout our suggested wire sizes based on voltage drop are:

Runs to twenty-five feet #16
Runs to fifty feet #14
Runs over fifty feet #12

For best results on long runs (over 20 feet), twist the bus wires about three turns per foot.

There is no special requirement for routing the power conductors with DCC. If you are going to have long runs of cab bus cabling along the front of the layout you should run the track bus wires nearer the rear to prevent potential "crosstalk" between the track signal and the cab bus.

Also recommended on layouts with long track bus or track blocks is a "snubber" wired across the bus or track. A snubber can easily be made from common parts available from Radio Shack or other electronic parts stores.

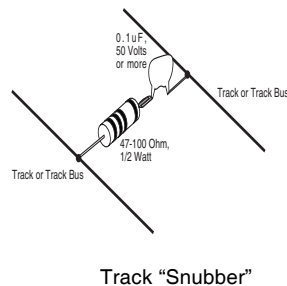

SYSTEM EQUIPMENT DESCRIPTIONS

The POWER PRO™ System Unit (5 Amp)

The Power Pro™ system unit is really two separate pieces of equipment in one box. The left half is the 5 Amp power booster (PB105) with the right half comprising the Command Station (the brains of the system). Each half is capable of operating independently of the other. We will first cover the Command Station portion then the PB105 power station half.

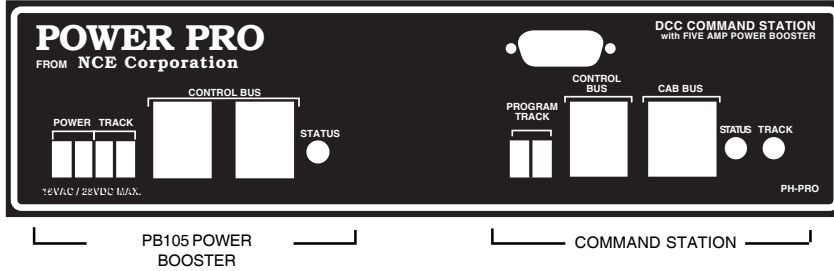

The POWER PRO™ PH-10 System Units

The Power Pro™ PH-10 system has two main pieces of equipment. The CS02 (top drawing) is the Command Station (the brains of the system). The PB110A (bottom drawing) is the 10 Amp power booster. Each box is capable of operating independently of the other. We will first cover the Command Station portion then the PB110A power booster.

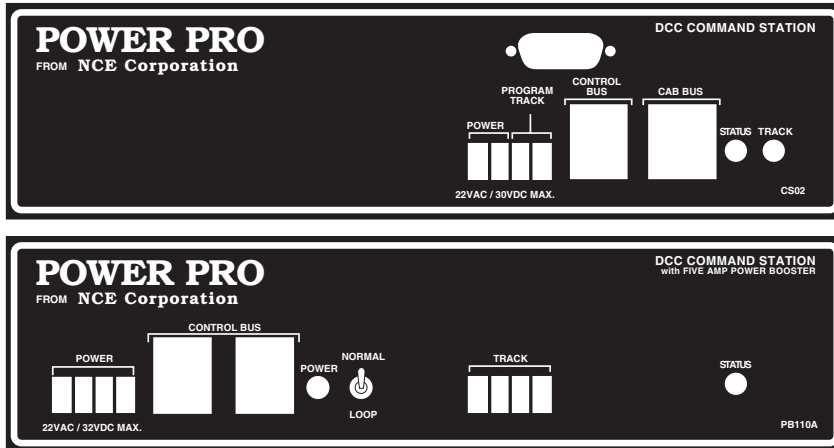

THE COMMAND STATION

COMMAND STATION CONNECTIONS AND INDICATORS

PROGRAMMING TRACK TERMINALS

The two connecting wires to your programming track should be connected here. We recommend using the last couple feet of a convenient spur track near the front of the layout. Both rails must be gapped (insulated joiners) at the break between the programming section and the main trackage.

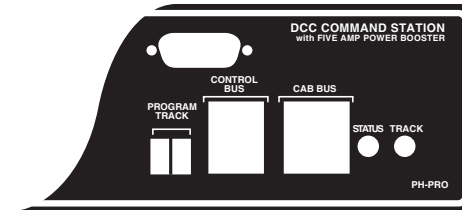

CAB BUS - 6 WIRE RJ-12 SOCKET

You may plug a cab directly into the cab bus jack or a cab bus cable may be used to connect to additional UTP connector panels around the layout. For small layouts and for checking-out the system before final wiring, the Cabs can be directly connected to the Command Station. For larger layouts this jack provides the ability to connect a longer/larger bus.

CONTROL BUS - 4 WIRE RJ-H SOCKET

Connect the 4 pin cable from this socket to the first Power Station. This is the low level DCC signal that will be amplified by the power booster(s).

COMPUTER INTERFACE PORT

This connector allows those hobbyists who wish to have access to their layout via a personal computer to do so. See the section on **RS232 SERIAL COMPUTER INTERFACE**.

TRACK LIGHT

Indicator light glows yellow to show normal system operation. A red or green glow indicates a problem with the Command Station.

STATUS LIGHT- This light is always off.

Power Pro Command Station Specifications:

Cabs: 63 maximum
Number of simultaneous trains: 250
Number of consists: 127 advanced consists of unlimited number of locomotives each. Plus 250 old style consists up to 4 locos each.
Range of locomotive addresses: 0-9999
Range of consist addresses: 1-127
Range of accessory addresses: 1-2044
Range of signal addresses: 1-2044
Computer interface: RS-232 included

Five Amp Power Booster Specifications:

Continuous Output Current: 5.14 Amps
Power requirements: 15VAC, 5 Amps (NCE P515 Power Supply)
Short circuit handling: Automatic shutdown after 500mS of short circuit
Output voltage: Factory set to 14 Volts, adjustable 9.5 to 18 Volts

REPLACING THE EPROM IN YOUR POWER PRO OR CS02:

From time to time NCE distributes updates for the Power Pro and CS02 system. These updates come in the form of an EPROM chip that replaces the existing EPROM in your command station.

Follow the steps below to install a new EPROM.

1. Unplug all cables from the front of the Power Pro (to make sure the power is off).
2. Remove the 4 cover screws from the Power Pro and slide off the cover.
3. Pry the EPROM straight up from the socket with a small flat blade screwdriver. Be sure to pry only under the chip and not the socket it is mounted in.
4. Carefully bend the leads of the new EPROM until they are straight down the sides of the EPROM to line up with the socket holes.
5. Insert the new EPROM into the socket being careful to get pin 1 into the correct hole. Pin 1 is indicated on the chip by a "half moon" cutout in the end of the chip.
6. Examine the installation to ensure all 28 pins have engaged the socket correctly.
7. Replace the cover (angled edge goes toward the front of the Power Pro) and its 4 retaining screws.

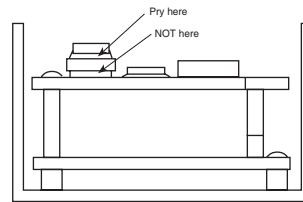
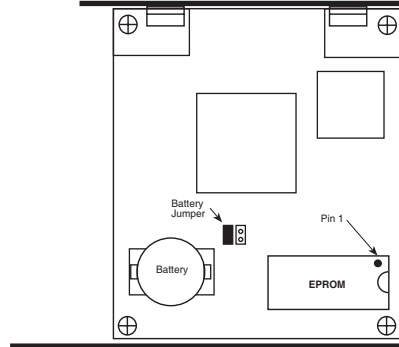

BATTERY

A battery back-up is provided to allow the Power Pro to remember Cab assignments, consists, etc. when the power is turned off. The battery should be replaced with **CR-2032 3 VOLT LITHIUM** in about 5 years. The battery should be replaced with the **power on** if you wish to retain all system settings. Be careful to not DROP the battery on active circuitry if you replace it with the power on. We put a scrap of notepaper over the lower circuit board(s) to prevent shorts if we accidentally drop the battery while changing it.

BATTERY CONNECT JUMPER

With the jumper installed the battery is on. Should the operator want to reset the Command Station to "FACTORY SETTINGS" remove the jumper, cycle the power to the Command Station OFF, then ON. All changes have now been cleared. Now re-install the jumper. If you leave the jumper off the command station will not remember any of its settings after you turn the power off.

POWER BOOSTER

PB105 and PB110A CONNECTIONS, CONTROLS and INDICATORS

Starting at the left side of the front panel, each terminal, socket, and indicator is explained below:

POWER TERMINALS:

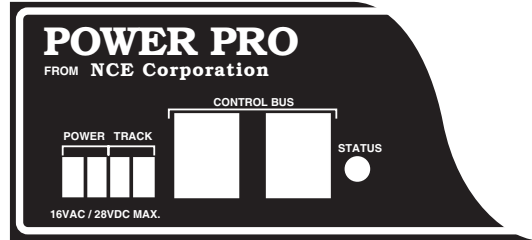

Input power from an outside power source goes into the PB-105 via the left most two screw terminals of the four terminal black connector. Always measure the transformer voltage before connecting it to your PB-105. A booster that has been 'over voltage'd will result in catastrophic booster failure and void the warranty (we can diagnose and determine if this has happened).

The screw terminals of the black connector are designed to accept wires up to #16 AWG (2mm). Insulation should be stripped back 1/4 inch (6mm). Only stranded wire should be used. If solid wire is used for track power, make a splice joint to stranded wire at some convenient place. Only stranded wire should enter the terminal for reliable contact. See the Basic Set Up of Your System at the front of this manual.

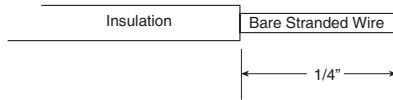

If you wish to purchase additional connectors, you may call NCE Corporation to order them.

THE TRACK TERMINALS:

NOTE: There are differences between the PB-105 and the PB110A boosters. See the Basic Set Up Drawings at the front of this manual for the proper set up directions.

Wires from these terminals go to the track. If more than one booster is connected to the layout, be sure the left track terminal on all boosters is consistently wired to the same rail. This will ensure you have the same "phase" as you cross power district boundaries. Always use wire of sufficient gauge (#16 minimum) to connect to the layout. Power "drops" of #24 or #22 wire to a larger wire bus under the track are fine as long as the length of each drop to the main bus is less than 12".

Use of a smaller bus will prevent the booster from detecting a short circuit and may be a fire hazard.

The voltage to the track is dependent on two factors: the power source input voltage and the setting of the internal voltage adjustment, as discussed later. The DCC track voltage for the Power Pro 5 Amp system is factory adjusted to the NMRA recommended 14 (+/- 0.1) volts for N, HO, and S scales. We do not recommend using a 5 Amp booster with O-Scale as most O-Scale locomotives have stall currents in the area of 8 Amps (Weaver, Red Caboose, P&D). For O-Scale usage we recommend our PB110A Ten Amp power booster. The PH-10 system is factory set for 16 volts.

CONTROL BUS SOCKETS

The control bus sockets on the front of the booster are paired to allow wiring the control signal coming from the command station to "daisy chain" through the booster. Use the supplied cable to connect the booster to the command station's CONTROL BUS socket. The remaining (unused) socket on the booster can be used to connect to other boosters

in daisy chain fashion. Use the 4-wire RJ-H cable for this purpose. Longer cables may be used if more distance is needed between power stations. The last power station at the end of the daisy chain will have one empty socket. The booster will place a nominal 10mA load on the command station control bus. In an emergency you can use a telephone handset cord to connect the control bus.

STATUS LIGHT

This light will illuminate steadily under normal operations. Flashing indicates an abnormal or fault condition. Here is a description of the various conditions indicated by the status light.

Steady on - Track power is on and operations are normal.

Rapid flash - No DCC signal from command station (control bus cable is unplugged, programming track in use, etc.).

Slower steady flash - Short Circuit (over current shutdown). The booster will shut down for 2-3 seconds or until the short or load of over 5.1 Amps is removed.

PB105 and PB110A TRACK VOLTAGE ADJUSTMENT

The track voltage is adjustable from 9.5 to 18 volts. Adjustment requires opening the case of the booster and turning the blue adjustment potentiometer as shown below.

Adjusting the PB105 DCC output voltage:

- 1) Set voltmeter to DC volts.
- 2) Touch minus (black) lead of meter to the indicated mounting screw at YY.
- 3) Touch plus (red) lead of meter to the rectangular silver circuit board pad marked VREG.
- 4) Turn DCC voltage adjustment pot to desired output voltage.
- 5) Adjust all boosters to the same voltage. Otherwise you will see a speed variation when you cross power district boundaries.

NOTE 1: Adjust the voltage with no appreciable load on track. The output voltage will rise slightly as more current is drawn to compensate for the drop in the output MOSFETs and associated wiring.

NOTE 2: If you have a means of measuring the track voltage (a typical "True RMS" reading meter will *NOT* be able to read the track voltage) the voltage can be adjusted through a hole in the back of the PB105 chassis without opening the cover.

NOTE 3: We do not recommend setting the track voltage above 16 volts. Voltage that high is very hard on any lights you may have installed in locomotives.

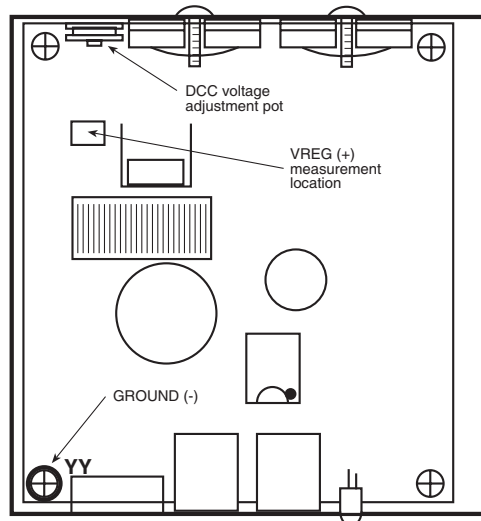

Adjusting the PB110A DCC Output Voltage

- 1) Set voltmeter to DC volts.
- 2) Touch minus (black) lead of meter to the indicated GROUND pad.
- 3) Touch plus (red) lead of meter to the rectangular silver circuit board pad marked VREG.
- 4) Turn DCC voltage adjustment pot to desired output voltage.
- 5) Adjust all boosters to the same voltage. Otherwise you will see a speed variation when you cross power district boundaries.

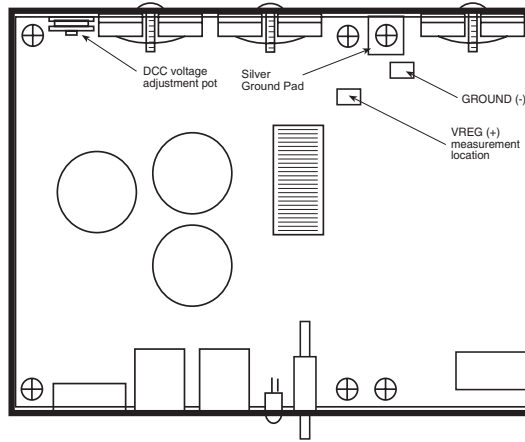

NOTE 1: Adjust the voltage with no appreciable load on track. The output voltage will rise slightly as more current is drawn to compensate for the drop in the output MOSFETs and associated wiring.

NOTE 2: If you have a means of measuring the track voltage (a typical "True RMS" reading meter will *NOT* be able to read the track voltage) the voltage can be adjusted through a hole in the back of the PB110 chassis without opening the cover.

NOTE 3: We do not recommend setting the track voltage above 18 volts. Voltage that high is very hard on any lights you may have installed in locomotives.

USING MULTIPLE BOOSTERS ON YOUR LAYOUT

The PB105 and PB110A are supplied from the factory ready for wiring to layouts where **both rails are gapped** at power district boundaries.

Double Gapped Layouts:

We recommend grounding ALL the power boosters together using wire between 18 to 24 AWG. You can use one of the cover mounting screws as the ground point on your Power Pro system box, PB105 or PB110. This will provide the necessary current return path for brass steam locomotives to operate across block boundaries.

Common Rail Layouts:

A simple modification is required to use multiple NCE power boosters with common rail layouts. For the PB105 booster, take the cover off the booster and remove the screw marked "YY" from the circuit board inside. This screw is located near the power connector. It is the only connection from the booster circuit common to the case. The input of the PB105 is optoisolated. For the PB110A, remove the screw from the square, silver ground pad at the rear, middle of the circuit board.

CONNECTION TO AUTOMATIC REVERSING MODULES

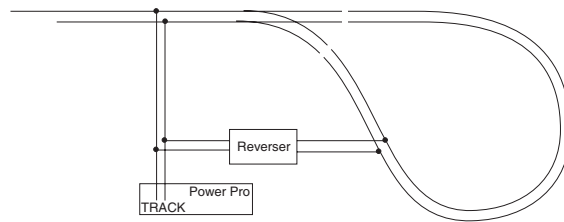

THE PROCAB

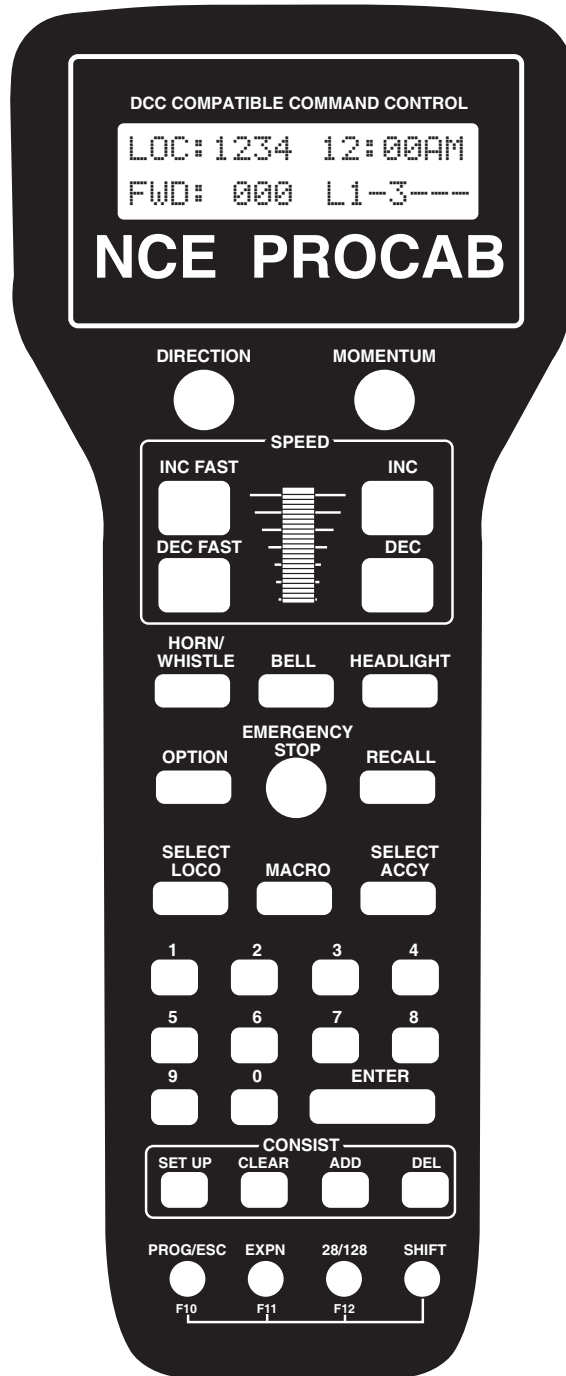

SET THE PROCAB ADDRESS

Just as every locomotive has a separate number (address in DCC terms) each cab needs a separate address so the command station can distinguish one cab from another. Each ProCab is shipped from the factory with the address of 2. If this is not your first ProCab you will have to change the address before using the cab. To easily change the address:

1. Power up your Power Pro system.
2. Plug in the ProCab cable to the CAB BUS connector of the Power Pro
3. Unplug your procab at the base of the cab
4. Press and hold the **SELECT LOCO** button while re-plugging in the cable you just removed from the cab
5. You should see the following display on the cab:



```
NCE PROCAB V1.3
CAB ADDRESS = 02
```

6. The cursor will be flashing over the 0 of "02". Type in the new cab number. In this case, you will press "3" (valid range = 1-63) followed by **ENTER**.
7. Press **PROG/ESC** to skip setting all the other cab setup options. They will be discussed later on page 22 of this manual.

THE LCD SCREEN

The LCD screen provides you with messages from the Power Pro Command Station. This information includes: locomotive status, scale time, command prompts and messages regarding programming decoders. The drawing above shows how the display looks during normal operation. The top line of the display includes the locomotive number

being controlled and the scale time. The second line shows the direction, speed and status of the locomotive function outputs. Decoder functions are represented with "L" for headlight or the function number 1 through 6 being ON. A dash ("-") indicating the function is OFF

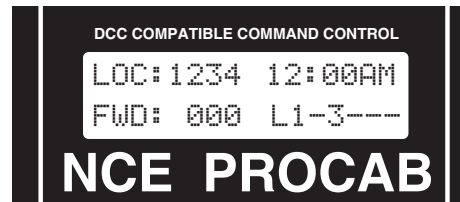

LOCOMOTIVE CONTROL AREA

DIRECTION

The **DIR** key changes the direction of your loco or consist. The current direction is displayed as the first three characters of the second line on the screen. This button is disabled if the cab is in Yard mode.



MOMENTUM

This key changes the acceleration/deceleration rate of the currently controlled locomotive/consist.

SPEED CONTROL SECTION

The digital encoder equipped ProCab allows you to use both the speed buttons and the knob for controlling the speed of your locomotive. The left two keys increase or decrease the speed by either 4 or 10 speed steps, depending on the speed step mode (28 or 128), whereas the right keys increase and decrease the speed by one speed step at a time.

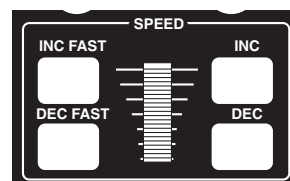

The knob increases the speed by rotating it up and decreases the speed when it is rotated down.

ProCabs have a feature called ballistic tracking. The faster you rotate the knob the faster it will increase or decrease the speed. This rate is adjustable from 0-7. The factory default value is 3. See the Cab Setup section later in this manual.

Note: Speed buttons are disabled if the ProCab is in Yard mode.

COMMONLY USED BUTTONS

HORN/WHISTLE

Factory default is to operate function 2 when this button is pushed. This can be changed in the **Set Cab Params** menu of the command station. Unlike other keys which toggle functions on/off this key blows the horn as long as the key is held down. Pressing the **2** key will still toggle the function on or off.

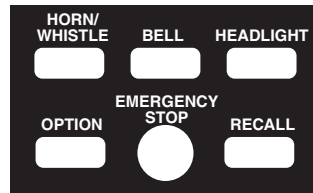

BELL

Factory default is a toggle for function “1” on or off with each button press. This can be changed in the **Set Cab Params** menu.

HEADLIGHT

Toggles the Headlight on and off. It is defined as Function 0, and pressing the 0 (zero) key will perform the same function, but we felt the headlight warranted its own button and a more convenient location.

OPTION

This button comes factory set to act as the BRAKE key. Pushing this button will set the speed of the currently controlled locomotive or consist to zero. This button can be programmed to act as any button you wish (see the CAB SETUP section on page 22, step 9).

EMERGENCY STOP

Pressing **EMERGENCY STOP** once will stop the active loco/consist for this Cab only. Speed will be immediately set to zero (no momentum). Loco is restarted by changing the speed step or direction. Pressing **EMERGENCY STOP** three times in succession will bring the *entire* layout to a stop by shutting off track power. “LAYOUT STOPPED!” will be displayed and is cleared by pressing the **ENTER** key. Only the Cab that executed the Emergency Stop can clear it. Each Loco or Consist can now be restarted by sending it a command, such as a speed increase or decrease, or by toggling a function.

RECALL

This button toggles between the last two to six locomotives or consists addressed. **RECALL** allows you to keep two to six locomotives and/or consists active in the command station memory and access them in “round-robin” fashion with each press of the button. Think of **RECALL** as being a set of memory slots. To put a locomotive in a recall “slot”, press **SELECT LOCO** and enter the loco or consist to be operated. To put another locomotive in the next slot, **first press RECALL** to access the next slot. Now press **SELECT LOCO** and enter the second loco. When additional trains are to be added either a “slot” with “000” or an expendable loco/consist must be displayed on the screen. Whatever is on the display will be replaced with the new loco/consist.

The number of RECALLS for each cab can be changed within the “SET CAB PARAMS” menu (see PROG button description). The factory default value is two. You may also “clear out” any locomotives in the recall slots using the “SET CAB PARAMS” menu. We don’t advise using RECALL in Yard mode. Because the ‘DIRECTION’ can be fouled inside the ProCab.

LOCO and ACCESSORY SELECTION GROUP

SELECT LOCO

This allows the selection of a locomotive/consist to operate. Press this key, the loco/consist number, then **ENTER**.



MACRO

When this key is pressed you are prompted to enter the macro number, then press **ENTER**. Macros are used to control one or more accessories with a single command. This is especially useful for selecting a route through a switch ladder in a staging yard or complex trackwork where it would be inefficient to throw several switches by selecting them individually. Macros are explained in detail later on page 37.

SELECT ACCESSORY

For controlling "accessory" decoders that operate accessories such as switch machines, lights, signals, etc.

DATA ENTRY/FUNCTION CONTROL

NUMBER KEYS

The keys **0** through **9** serve two purposes. First, when operating a loco/consist if a number key is pressed it toggles the corresponding function on the loco (if that function is connected and supported by the decoder). The second purpose is for typing in numbers such as when selecting locomotives or responding to screen selections during programming.

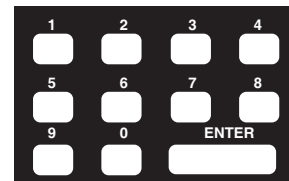

ENTER

Used to confirm numeric inputs or select a programming mode.

CONSIST SETUP GROUP

Supports not only advanced decoders that respond to the Extended Packet Format but also the older entry-level decoders. For complete operating instructions on consist makeup read the section on **SETTING UP A CONSIST** on page 28.



SETUP

Starts the procedure for either creating an advanced or old style (some call it Universal) consist.

CLEAR

Disbands (breaks up) a consist.

ADD LOCO

Adds a locomotive to a consist.

DELETE LOCO

Drops a locomotive from a consist.

PROGRAMMING and EXTENDED FUNCTION CONTROL

PROG/ESC/F10

Provides selection of the various system menus available for setting up decoders, cabs, time, etc.

This button also doubles as an “**escape**” key during number/data entry. Whenever the cursor (flashing rectangular box) is shown on the cab display to indicate the cab is waiting for data to be input you can press **PROG/ESC** to cancel the data entry and return to normal operations.

The following menus are accessed round robin fashion with each successive press of the **PROG/ESC** key when in normal operations:

- First press: Program on the Main (Operations Mode programming)
- Second Press: Assign loco to Cab
- Third Press: Set Fast Clock
- Fourth Press: Use programming Track
- Fifth Press: Set up Command Station
- Sixth Press: Set up Cab Parameters
- Seventh Press: Program accessory decoders on the mainline
- Eighth Press: Set up Macros (switch route control)
- Ninth press: Browse Advanced Consists
- Tenth press: Program Signal decoders on the mainline

Pressing **ENTER** at any of the above menus will select that menu, pressing **PROG/ESC** will step to the next menu. You can use ‘shortcuts’ to get to the menus you like. For example: Pressing **PROG/ESC** followed by 4 takes you to the Program Track menu.

Pressing **SHIFT** and **PROG/ESC** activates F10.

EXPN/F11

Reserved for future features. When the cab is wireless this button is used to access the radio setup menu. When the cab is tethered, it toggles between the function status for F1-F28 and the normal LCD display. Pressing **SHIFT** and **EXPN** activates F11.

28/128/F12

Provides the ability to toggle between 28 and 128 speed step operation of the active loco/consist. Pressing this button will display the speed step mode you have selected on the cab LCD. The LCD display will be set to the normal operation display the next time a function is toggled or **ENTER** is pressed. Pressing **SHIFT** and **28/128** activates F12.

SHIFT

This button gives each key on the ProCab an “alter ego”. When pressed and held while pressing another key on the cab the alternate value of that key can be used. For example: To access the function F10 you simply press **SHIFT** and **PROG/ESC** at the same time to activate FUNCTION 10. Every key can be programmed to any current or future feature we may think up. This is like having a whole cab full of OPTION keys. Each key is preprogrammed at the factory to one of these alternate uses. Try pressing **SHIFT** and 4. This takes you directly to the USE THE PROGRAMMING TRACK menu. A list of the shifted keys is tabulated on page 25.

When the radio control option is installed the **SHIFT** button will also turn on the backlight of the LCD for about 5 seconds. If more keys are pressed within the 5-second period the

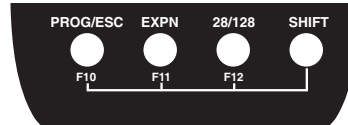

time on will be extended by 3 seconds each time a key is pressed. This will save LOTS of battery power by not having the backlight on continuously.

EXTENDED FUNCTION CONTROL (F10 - F28)

Control of functions **F13** through **F28** has been added. To access these function numbers program the **OPTION** key to a value of **122** (see CAB SET UP, below). Pressing **OPTION** will display "**F10** through **F19**" on the bottom line of the cab. Pressing a digit will toggle that number plus ten. For example, pressing **6** will issue an **F16** command.

Pressing **OPTION** a second time will display "**F21** through **F28**" on the cab. Pressing a digit with this display will toggle that number plus twenty.

Pressing **OPTION** a third time will return to the **F10** through **F19** display. Pressing **Prog/Esc** at any time will abort the operation.

CAB SETUP

The ProCab has various internal setup parameters and operating modes. The following steps describe the parameters you can change to customize the cab to your liking.

To access the cab set up mode:

- 1) Turn on the command station
- 2) Unplug your cab from the command station
- 3) Press and hold down the **SELECT LOCO** button while plugging in the cab. The cab will now enter its internal setup program. At any time you may press **PROG/ESC** to leave set up mode.
- 4) Press **ENTER** to accept the current cab address (unless you want to change it). To change the cab address, type in a new address such as 3 followed by the **ENTER** key. If you make a mistake just unplug the cab and re-plug it while holding down the **SELECT LOCO** key.
NOTE: If you program the address to zero the cab will reprogram itself to the original factory values, including the cab address, which will be set to 2.
- 5) At the "1=YARD 2=NORMAL" prompt you can press **ENTER** to accept the current operating mode. To select between "normal" operation where the speed knob stops at speed 0 when turned all the way down or "yard" mode. In yard mode as the knob is turned down to zero it will reverse locomotive direction and start increasing speed in reverse as the knob turning in the "down" direction is continued. Pushing the knob up will reduce the reverse speed to zero the increase it in a forward direction. **The factory setting is 2 for "normal" Operation**
- 6) Press **ENTER** to accept the existing Ballistic Tracking Rate or enter a new rate. Entering a low number will cause speed knob to change locomotive speed more slowly as the knob is turned, larger numbers will cause a greater change of speed as the knob is turned. **The factory setting is 3 and values from 0-7 will be accepted.**
- 7) Press **ENTER** to accept the Speed Button Repeat Rate. This is the rate at which the 4 speed control buttons repeat. Smaller values will make the buttons repeat faster. The acceptable range is 16 to 255. **The factory setting is 32.**
- 8) Press **ENTER** to accept the current Speaker On Time or enter a new value. Smaller values generate a short "beep" as the speed knob is turned through zero when in yard mode and larger numbers generate a longer beep. Values from 0-99 are accepted. **The factory value is 3.** NOTE: The beep will only work if there is a speaker installed in the ProCab.
- 9) Press **ENTER** to accept the current OPTION key value. If you wish to change it enter a number from the Key Table Chart following this section. **The factory value is 94** so the OPTION button will act as BRAKE button.
- 10) Press **ENTER** to accept the "shifted" value for key number 1. If you wish to change it enter a number from the Key Table Chart following this section. See the Table of Factory Default Values for Shifted Keys on page 25 for the preset factory values.
- 11) Use the same procedure described in step 10 to accept or program keys number 2 through 32. Remember you can press PROG/ESC to exit at any time. If you stick it out to key 32, press **ENTER** to return to normal operations mode.

Key Table Chart

Value	Key Name	Value	Key Name
64	Enter	96	Assign Loco to Cab
65	Program	97	Program on Main
66	Recall	98	Set Clock
67	Direction Toggle	99	Use program track
68	Setup consist	100	Setup command station
69	Add loco to consist	101	Setup Procab
70	Delete loco from consist	102	Setup macros
71	Kill consist	103	Setup old consist
72	Select loco	104	Setup advanced consist
73	Horn/Whistle	105	Display F1-F28 status
74	1 Speed step faster	106	Forward
75	1 Speed step slower	107	Reverse
76	Emergency Stop	108	Select Signal
77	Bell	109	Reserved
78	Select Accessory	110	Reserved
79	Expn (Expansion) key	111	Momentum
80	Headlight, Zero key	112	F10
81	F1, number 1 key	113	F11
82	F2, number 2 key	114	F12
83	F3, number 3 key	115	Reserved
84	F4, number 4 key	116	Reserved
85	F5, number 5 key	117	Reserved
86	F6, number 6 key	118	Reserved
87	F7, number 7 key	119	Reserved
88	F8, number 8 key	120	Reserved
89	F9, number 9 key	121	Reserved
90	4/10 speed steps faster	122	F10-F28 Status
91	4/10 speed steps slower	123	Reserved
92	Macro	124	Reserved
93	28/128 select	125	"no key" pressed
94	Brake (factory setting)	126	Reserved
95	Do not use	127	do not use

ProCab Specifications:

Size: 8-3/4 x 3-5/8" x 1"

Power Requirements: 8 VDC 40mA (backlight off)
8 VDC 120mA (backlight on)

Replacement Encoder: Bournes or Digkey part #3315C-1-006L

Speed control: Thumbwheel operated digital encoder with adjustable ballistic tracking rate. Pushbutton speed control with adjustable auto-repeat rate (4 pulses per second to one pulse per 4 seconds).

Backlit LCD Display: 2 line by 16 characters/line. Two extra display lines available for display of additional information when used with computer dispatcher programs.

PROCAB BUTTON NUMBERING SCHEME

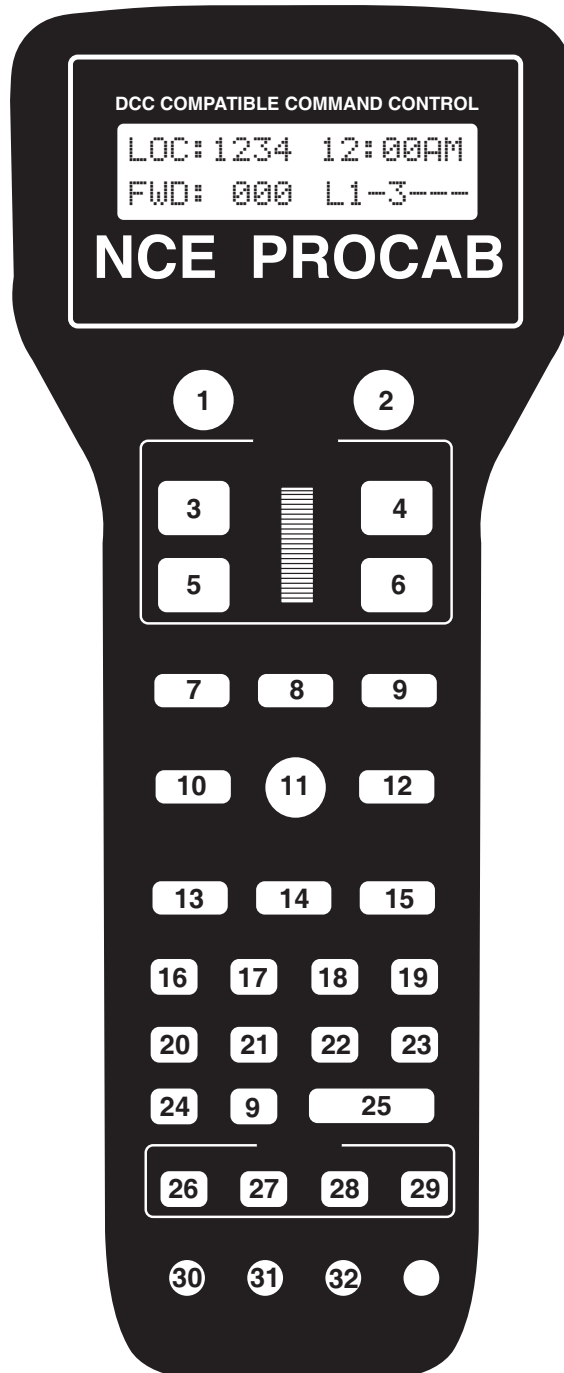
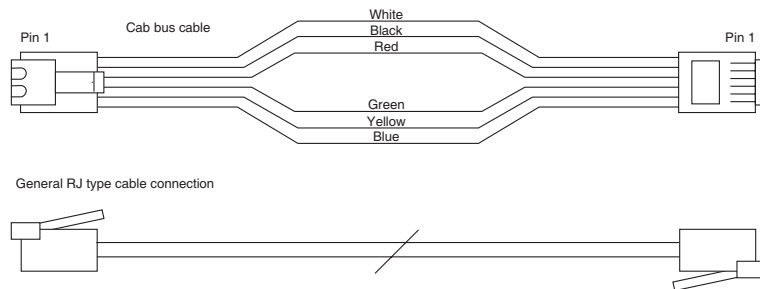

TABLE OF FACTORY DEFAULT VALUES FOR "SHIFTED" KEYS

Key #	Value	Description	Key #	Value	Description
1	67	Direction	17	96	Assign Loco -> Cab
2	94	Brake	18	98	Set Clock
3	90	Increment 4/10 steps	19	99	Use Program Track
4	74	Increment 1 Step	20	100	Setup Command Station
5	91	Decrement 4/10 steps	21	101	Setup Cab Parameters
6	75	Decrement 1 Step	22	118	Reserved
7	123	reserved	23	102	Setup Macros
8	81	Headlight	24	108	Reserved
9	122	reserved	25	119	Reserved
10	125	reserved	26	103	Setup Old Consist
11	116	reserved	27	108	Reserved
12	109	reserved	28	120	Reserved
13	121	reserved	29	115	Reserved
14	117	reserved	30	112	Function 10
15	111	Momentum	31	113	Function 11
16	97	Program on Main	32	114	Function 12



6 WIRE CAB BUS CABLE WITH RJ-12 CONNECTORS

Pin #	Color	Description
Pin 1	White	No Connection, reserved
Pin 2	Black	Ground
Pin 3	Red	- RS-485
Pin 4	Green	+ RS-485
Pin 5	Yellow	+12 volts
Pin 6	Blue	No Connection, reserved

OPERATING PROCEDURES

THE "NORMAL" DISPLAY

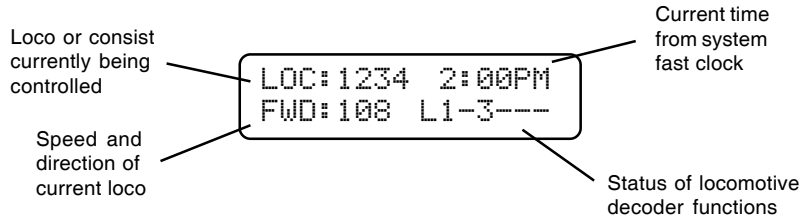

TOP ROW OF DISPLAY

LOC: Indicates that a locomotive is being operated.

CON: Indicates that a consist is being operated.

2:00PM: Scale Time in either 12 hour or 24 hour format.

BOTTOM ROW OF DISPLAY

FWD: or REV: Indicates the current direction of loco or consist

108 - Indicates the speed step to which the active loco/consist is presently set.

L123456 or - - - - -

Indicates which function outputs are ON. Those outputs that are OFF are displayed as dashes (-). The example above indicates that the Headlight, Function #1 and Function #3 are on.

Other status information may temporarily be displayed in this area.

SELECTING A LOCOMOTIVE OR CONSIST

First a word about locomotive addresses. A decoder can have 2 different addresses, the Short Address (values from 1-127) and the Long Address (sometimes called 4 digit with a range of 0000-9999). A decoder can use one or the other but not both at the same time. Some entry level decoders can only use the Short Address.

As you can see above there is an overlap in the address ranges between the short and long address. You can have a **Long Address** of 6 and a **Short Address** of 6. They are *not* the same. To use a short address (range 1-127) it is selected on the cab by entering only the significant digits (no zeros before you get to the numbers). To enter a long address in the range of 0-127 put a zero before the digits. A long address between 0 and 127 will have an asterisk (*) before the loco address on the cab display as below:

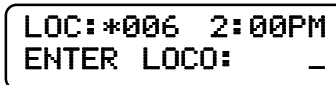

NOTE: You will notice that the short address 0 is not available but the long address 0 is listed as a valid address. Short address 0 is the "broadcast" address for DCC. If you were to send commands to short address 0 all locomotives on the layout would respond causing chaos. For this reason we don't allow use of short address 0. Long address 0 can be used just like any other locomotive address.

To select a locomotive for operation:

- Press the **SELECT LOCO** button
- Enter the 1 to 4 digit address of the loco/consist to be operated. A “Leading Zero” is necessary for **long** addresses below 128. An asterisk will be displayed before any long address below 128 (example below).
- Press the **ENTER** key.

Locomotive address examples:

4421 = Long Address

006 = Long Address as entered.

*006 = Long Address as displayed

45 = Short Address as entered

045 = Short Address as displayed

LOC: will be displayed when addressing a single locomotive

CON: will be displayed when addressing a Consist.

CONTROLLING HEADLIGHTS AND OTHER DECODER FUNCTIONS

Pressing **HEADLIGHT** will alternately toggle the headlight of the locomotive on and off. To toggle other functions simply press the number key that corresponds to the function you wish to control. E.g. - The ‘1’ key controls function 1.

Your cab will display which functions are on and off on the lower right of the display. The letter ‘L’ stands for Headlight (Function 0) and numbers 1-6 stand for functions 1-6 (functions 7 through 12 are not displayed on the cab but work if you push the buttons). In the example below the headlight plus functions 2 and 6 are on.

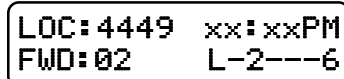

```
LOC: 4449  xx:xxPM
FWD: 02    L-2---6
```

Control of functions F13-F28 has been added. To access these function numbers program the **OPTION** key of any cab to a value of 122. Pressing **OPTION** will display F10-F19 on the bottom line of the Pro Cab LCD. Pressing a digit will then toggle that function number plus ten. For example pressing 6 will issue an F16 command.

Pressing **OPTION** a second time will display F21-F28 on the LCD. Pressing a digit with this display will toggle that function number plus twenty.

Pressing **OPTION** a third time will return to the F10-F19 display.

Pressing **PROG/ESC** at any time will abort the operation.

OLD AND ADVANCED CONSISTS EXPLAINED

Before setting up any consist an explanation is needed to understand the operating differences between Advanced and Old Style consists (also called brute force or Universal). Basic decoders that have a short address but no CONSIST address (Early Lenz, MRC 30x/31x series and Digitrax 120 series decoders) can not be used with advanced consisting.

ADVANCED CONSISTS

Decoders that support advanced consisting have an additional short address, the CONSIST address, in addition to their normal Long and Short addresses. The consist address is stored in CV19 and can have a value of 1-127.

A decoder considers itself in a consist if the Consist Address (CV19) is something other than 0 or 128. A decoder is added to a consist when the command station sends a command to set the consist address in the decoder to the consist number. The decoder will now use this new consist address for speed and direction commands. This has many advantages including the need for fewer communications on the track and no need for the operator or command station to keep track of which locomotives are in what consist on the layout.

Each locomotive in an advanced consist will still respond to function or programming commands at the original locomotive address. This means the operator can turn lights or other functions on or off for each locomotive individually.

To kill an entire consist, a command is broadcast on the tracks for each decoder with that consist number to clear its consist address and return to individual operation.

Locomotives can also be individually dropped from a consist. You can also add locomotives to a consist after the initial set up of that consist.

Advanced style consists can easily be taken from layout to layout and they will continue to operate as a single unit.

OLD STYLE CONSISTS (also called brute force or Universal)

With an Old Style consist, the command station keeps track of each locomotive in a consist within the memory of the command station. Each speed change of the cab generates a separate speed command to **each** of the decoders in the consist. These extra speed commands on the track have significant ramifications if you have a lot of consists operating at one time as in a club situation. The effect is to slow down locomotive response to the throttle speed controls.

Use this method of building a consist with MRC and Digitrax 120 series decoders.

Decoders in an old style consist have no knowledge of being in a consist and will not operate as a unit when moved to another layout. You can add one or more advanced consists to any old style consist.

SETTING UP AN ADVANCED CONSIST

To set up a consist press **SETUP**. This screen allows you to choose the type of consist to be created. For those consists that will contain advanced decoders, press **ENTER** to select the advanced mode.

```
CONSIST 2:00PM
ENTER=ADV 1=OLD
```

An advanced consist has *no* limit to the number of loco's assigned.

NOTE: you can not setup, add a loco to, or delete a loco from a consist while the locomotive is moving. It must be at speed 0. Decoders will not accept consist commands while they are in motion. This prevents reception of false consist make/break commands due to electrical noise generated by the wheels rolling on the track.

CONSIST ADDRESS:

The consist address can be any number from 1 through 127. The system will suggest the first available consist address (the priority is highest to lowest). Press enter to accept this address.

```
SETUP      2:00PM  
CON ADDR:  127
```

You may enter any other number you wish then press the **ENTER** key. If you have locomotives on the layout using short addresses make sure you don't pick an address already in use. This is one reason to use long addresses with your loco fleet. It will keep the short addresses free for consists.

ENTERING THE LEAD LOCO NUMBER

Entering the lead loco number is optional but recommended. The command station keeps track of consists by their lead loco number. The locomotive is the loco that the command station will send function commands to. For example: headlight on/off commands. If the command station did not know the lead loco it would not know which locomotive should have the headlight turned on or off.

The lead loco number also acts as an *alias* for the consist number entered above. Say you have a bunch of consists stored on staging tracks and you wish to operate one of them. After the consist is set up, you can select the consist by pressing **SEL LOCO** then entering either the lead loco number or the consist number. The lead loco number is typically easiest to remember because it is the number printed right on the locomotive. The consist address may not relate to any visible or easily remembered number.

```
SETUP      2:00PM  
LEAD LOCO:  -
```

Enter the lead loco number followed by pressing the **ENTER** key.

ENTERING THE LEAD LOCO DIRECTION

If the locomotive is to operate in the forward direction press **ENTER**. Press the **DIRECTION** key if you wish to have the locomotive operate in the reverse direction. Subsequent presses of the **DIRECTION** key will keep changing the direction. When you get the direction you desire press the **ENTER** key.

```
CONSIST    2:00PM  
DIR THIS LOCO: F
```

This informs the decoder if the loco is in the line-up facing forward or reverse. For instance, in an A-B-A consist the lead A unit and the B unit will be setup in the Forward direction, and the second A unit will be setup in the Reverse direction.

ENTERING THE REAR LOCO NUMBER

Entering the rear loco number is optional. The command station keeps track of consists by their lead or rear loco number. If you select the consist by the rear loco number the direction of the consist will be reversed from the direction of operation if you selected it by the lead loco. You don't have to enter a rear loco number if you don't need/want to operate the consist in reverse. The rear loco number also act as an *alias* for the consist number just as the lead loco number.

```
SETUP      2:00PM  
REAR LOCO:  -
```

Enter the rear loco number followed by the **ENTER** key.

ENTERING THE REAR LOCO DIRECTION

If the locomotive is to operate in the normal direction press **ENTER**. Press the **DIRECTION** key if you wish to have the locomotive operate in the reverse direction. Subsequent presses of the **DIRECTION** key will keep changing the direction. When you get the direction you desire press the **ENTER** key.

```
CONSIST 2:00PM
DIR THIS LOCO: F
```

ADDING A MID-CONSIST LOCO

At this point you can start to add more locomotives to the consist. Enter the next locomotive (decoder address) followed by pressing the **ENTER** key. If you don't want to add any more locomotives to the consist just press **ENTER**.

```
CONSIST 2:00PM
ADD LOCO: -
```

ENTERING THE LOCO'S DIRECTION

```
CONSIST 2:00PM
DIR THIS LOCO: F
```

As with the lead locomotive, this informs the decoder if the loco is in the line-up facing forward or reverse.

If the locomotive is to operate in the normal direction press **ENTER**. Press the **DIRECTION** key if you wish to have the locomotive operate in the reverse direction. Subsequent presses of the **DIRECTION** key will keep changing the direction. When you get the direction you desire press the **ENTER** key.

At this point you will be prompted to add additional locomotives. If you don't want to add any more locomotives to the consist just press **ENTER** or **PROG/ESC** with out entering an address.

DROPPING A LOCOMOTIVE FROM AN ADVANCED CONSIST

To delete a consist locomotive press **DEL**

```
DEL LOCO 2:00PM
ENTER LOCO: -
```

This will drop the loco identified from whatever consist it was part of. There is no need to know the consist number for this operation. Deleting a loco sets CV19 to a value of 0 in that loco.

ADDING A LOCO TO AN ADVANCED CONSIST

Select the consist.

```
ADD LOCO 2:00PM
CONSIST ADDR: -
```

Press **ADD** . Enter the address of the consist, or lead loco, to which the loco is to be added and then press the **ENTER** key.

```
ADD LOCO 2:00PM
ADD LOCO: -
```

Enter the loco number to be added and press the **ENTER** key.

Enter the loco's direction

```
CONSIST    2:00PM  
DIR THIS LOCO: F
```

If the loco is to operate in the normal direction press **ENTER**, otherwise press the **DIRECTION** key followed by pressing the **ENTER** key. This informs the decoder whether the locomotive is in the line-up facing forward or reverse.

CLEARING AN ADVANCED CONSIST

Press **CLEAR**. Select the consist to be cleared.

```
LOC:4449 2:00PM  
KILL CONSIST: _
```

Enter the lead or rear loco number and press **ENTER**. This sends a command to all decoders with this consist address to clear the consist address from the decoder. You can also enter the consist address if you know it. All locomotives that were assigned to this consist will no longer respond to the consist address.

CHANGING THE LEAD/REAR LOCO

Under some circumstances it is desirable to change which locomotive is to act as the lead loco of a consist. One of these circumstances is when you want to drop the lead/rear loco from the consist. It is possible to drop the lead or rear loco from an advanced consist. If you drop one of these locos you will be prompted for a new lead (or rear) loco. The new lead (or rear) loco *MUST ALREADY* be a member of the same consist.

This mid-consist loco is "promoted" to lead or rear status and the consist can now be selected by that address just as it could be selected by the old lead status.

Just pressing **ENTER** at the prompt for a new lead loco will clear out the lead (or rear) loco address "slot" in system memory. If you drop both the lead and the rear locos without adding at least one in the lead or rear, any mid-consist locomotives will remain in the consist. The consist then can only be selected by the consist address as no lead or rear loco is in memory to identify it.

The locomotive that was dropped from the consist will be selected for operation. We assume that if you drop the loco you will want to move it away from the remaining consist.

If the same consist is in a cab recall slot that was selected by the dropped locomotive address, the cab can operate the consist but the cab display will still show the dropped loco's address as the lead loco. Reselecting the consist by the new lead (or rear) number will correct the problem.

OLD STYLE CONSISTS

SETUP AN OLD STYLE CONSIST

```
CONSIST  2:00PM  
ENTER=ADV 1=OLD
```

Press **SETUP**. This screen allows you to choose the type of consist to be created. For those consists that will contain any basic decoders, press **1**. Please note that the limit on an old style consist is four locomotives or advanced consists. NOTE: Once you setup an old style consist you will not be able to select a new locomotive to run unless you store the consist away by pressing recall (or clear the consist). Each cab may have up to 6 old style consists in recall.

INITIAL SCREEN DISPLAYED

```
CON:  000  2:00PM  
      000  000  000
```

This screen is displayed to show all 4 "slots" for loco's in the consist are empty. Press the **ENTER** key to continue.

ENTERING THE LEAD LOCO NUMBER

```
CON:  000  2:00PM  
ADD LOCO:  _
```

Enter the loco number followed by the **ENTER** key. The first loco to be added will be the lead loco (the lead loco number will be displayed on the screen during normal operation). The consist will respond to this number.

ENTERING THE LOCO DIRECTION

```
SETUP      2:00PM  
DIR THIS LOCO: F
```

The locomotive direction is assumed to be forward, if it is to operate in reverse press the **DIRECTION** key. This informs the command station if the loco is in the line-up facing forward or reverse. This affects only the direction of the loco, not lighting. Press the **ENTER** key to continue.

The operator needs to press **ADD** for every loco to be added. This operation leaves the consist as the active unit for this Cab. By pressing **RECALL** the operator can change to another loco/consist but the old style consist will stay with this Cab until it is either passed by assigning it to another Cab or is cleared.

OLD STYLE CONSIST FULL

```
CON:  012  2:00PM  
CAN NOT ADD LOCO
```

The consist contains four loco's which is the maximum amount that we support in this style of consist. Press the **ENTER** key to continue.

FOLLOW-UP SCREEN

```
CON: 012 02:00PM  
CONSIST NOW FULL
```

This screen reaffirms the previous screen. Press the **ENTER** key to continue.

```
CON: 042 2:00PM  
008R 101 4449R
```

The **R** indicated that the loco is reversed in the consist.
Loco 42 is the lead loco (short address of 42).
Loco 8 is a loco operating backwards.
Loco 101 is a locomotive operating forward.
Loco 4449 is a locomotive operating backwards.

ADDING A LOCO TO AN OLD STYLE CONSIST

```
CON: 012 2:00PM  
FWD: 000 L-----
```

With an Old Consist, you can only add a loco to an active consist on your cab. If the consist is not active press **RECALL** until you have the consist active or acquire the consist from another cab by "ASSIGN LOCO TO CAB".

ENTERING THE LOCO NUMBER

```
CON: 012 2:00PM  
ADD LOCO: -
```

Enter the loco number to add and press **ENTER**.

ENTERING THE LOCO DIRECTION

```
CON: 012 2:00PM  
DIR THIS LOCO: F
```

If the locomotive is to operate in the forward direction press **ENTER**. Press the **DIRECTION** key if you wish to have the locomotive operate in the reverse direction. Subsequent presses of the **DIRECTION** key will keep changing the direction. When you get the direction you desire press the **ENTER** key.

DROPPING A LOCO FROM AN OLD STYLE CONSIST

```
CON: 012 2:00PM  
FWD: 120 L-----
```

You can only delete a loco from an active consist on your cab. If the consist is not active press **RECALL** until you have the consist active or acquire the consist from another cab by "ASSIGN LOCO TO CAB". Press **DEL**.

```
DEL LOCO 2:00PM
ENTER LOCO:  -
```

This will drop the intended locomotive from old style consist. Enter the loco number and the press **ENTER**.

ERROR MESSAGE

```
DEL LOCO 2:00PM
NOT IN CONSIST:
```

This message will display when the loco selected is not in the active consist.

CLEARING AN OLD STYLE CONSIST

```
CON:12  2:00PM
024  056  078
```

Press **CLEAR**. You can only clear an old style consist if it is the active consist on your cab. If the consist is not active press **RECALL** until you have the consist active or acquire the consist from another cab by "ASSIGN LOCO TO CAB".

CONFIRM THAT THE CONSIST IS TO BE KILLED

```
KILL?  02:00PM
ENTER=NO 1=YES:
```

Press 1 to clear the consist from the Command Station memory. All locomotives that were in the consist may now be selected and operated independently.

CONTROLLING TURNOUTS AND OTHER ACCESSORIES

ENTER THE ACCESSORY NUMBER TO BE OPERATED

```
CONTROL 02:00PM  
ACC NUMBER: -
```

Press **SELECT ACCY** key. Enter the address of the accessory to be operated. Followed by pressing the **ENTER** key. Valid accessory addresses range from 1 to 2044. The number 2044 is the "Broadcast" address for accessories.

TURN ACCESSORY ON OR OFF

```
ACC: 003 02:00PM  
1=N 2=R NOW=NORM
```

Press **1** to turn accessory ON. (Switch machine set to Normal)
Press **2** to turn accessory OFF. (Switch machine set to Reverse)

NOW= NORM or REV - The command station keeps a database of the last accessory (turnout) commands sent for all accessory addresses. The bottom line of SELECT ACCY prompt on the Pro Cab LCD reflects the current status of the accessory.

A convenience feature has been added. Pressing SEL ACCY twice at the SEL ACCY prompt will toggle (reverse) the position of the current accessory.

THE MOMENTUM BUTTON

When you press the momentum button you are prompted to enter a momentum level. There are 9 levels of momentum (1-9) plus 'direct drive'(0). Pressing a digit button from 0-9 will automatically set the acceleration and deceleration rates of the locomotive(s) being controlled.

Pressing 0 sets the momentum of the train to 0 effectively turning it off. 1 is the smallest amount of momentum, 9 is the most.

If you are operating an Advanced or Old Style consist setup in the command station all locomotives will have their momentum set. If an Old Style consist includes one or more Advanced consists all locomotives in the Advanced consist (up to 6 per advanced consist) will also have their momentum set properly.

Technical stuff - what happens when you set momentum

The digit entered is multiplied by 8 (factory default) and sent to CV3. The value sent to CV4 is ½ half (factory default) the value sent to CV3. You can change these multipliers.

You can setup the following momentum parameters in the SET CMD STA menu:

The acceleration multiplier can be set to a value in the range of 0-25.

The deceleration can be set to FULL or HALF the value sent to CV3.

You can disable the sending of momentum commands to consists.

If a decoder follows NMRA Recommended Practice 9.2.2 the rates will be as shown below with the factory default settings (multiplier = 8 and deceleration = half).

Rate 1 = 7 seconds to full speed, 3 seconds to stop

Rate 2 = 14 seconds to full speed, 7 seconds to stop

Rate 3 = 21 seconds to full speed, 10 seconds to stop

Rate 4 = 28 seconds to full speed, 14 seconds to stop

Rate 5 = 35 seconds to full speed, 17 seconds to stop

Rate 6 = 42 seconds to full speed, 21 seconds to stop

Rate 7 = 49 seconds to full speed, 24 seconds to stop

Rate 8 = 54 seconds to full speed, 27 seconds to stop

Rate 9 = 61 seconds to full speed, 30 seconds to stop

If a consist is active when MOMENTUM is pressed the button will do nothing unless "CONSIST MOMENTUM" is enabled (factory default) in the SET CMD STA menu. Momentum commands will be sent to a limit of 6 locos per Advanced consist.

Notes regarding momentum commands and decoders:

There are special commands for setting *consist* momentum (CV23 and CV24) but many decoders *do not* support these CV's.

CV3 and CV4 are **required** and have standardized values in decoders per RP-9.2.2. Support for consist CV23 and CV24 is **not required** in decoders, this is why we use CV3 and CV4 for consist momentum..

Sound equipped locomotives that verbally speak the value of CVs must be turned off by setting CV 62 to a value of 0 for momentum to work properly. Setting CV 62 to a value of 1 turns the verbal response back on.

USING MACROS TO CONTROL TURNOUTS

MACROS EXPLAINED

Macros are really a list of turnouts controlled by accessory decoders that you wish to operate as a group. There are a total of 256 of macros, each one capable of controlling up to 10 turnouts. Macros may be 'chained' with other macros to create complex routes with hundreds of turnouts.

ENTER THE MACRO NUMBER TO BE EXECUTED

```
LOC: 1023 2:00PM  
MACRO NUMBER: -
```

- Press **MACRO** key.
- Enter the number of the macro (0-256) to be executed
- Press **ENTER**.

MACRO NOT SET UP

```
ERROR: 02:00PM  
-MACRO IS EMPTY-
```

This message will be displayed if no macro has been programmed for the number entered.

MACRO PROGRAMMING

To program a macro see the PROGRAMMING MACRO section, page 68.

PROGRAMMING PROCEDURES

ACCESSING PROGRAMMING MODES

To access the various programming modes, press the **PROG** key. The following messages will be displayed for each press of the **PROG** key. When the desired mode is displayed, press the **ENTER** key to enter that mode. To quickly get to a programming mode, press the **PROG** key and then press the number of the screen. If you have pressed the **PROG** key by mistake, or want to exit out without having to press the **PROG** key several times, press **EXPN**. Refer to the following sections for the individual programming instructions. To escape from any programming session press the **PROG** key.

To program locomotive decoders on the main (OPS mode) press **ENTER**.

```
SEL MODE 02:00PM  
PROGRAM ON MAIN
```

To assign a locomotive/consist to a Cab press **ENTER**. [2]

```
SEL MODE 02:00PM  
ASSIGN LOCO->CAB
```

To start, stop, or set the System Clock press **ENTER** [3]

```
SEL MODE 02:00PM  
SET SYSTEM CLOCK
```

To program on the program track press **ENTER**. [4]
To set command station parameters press

```
SEL MODE 02:00PM  
USE PROGRAM TRK
```

ENTER. [5]
To set the Cab parameters press **ENTER**. [6]

```
SEL MODE 02:00PM  
SET CMD STATION
```

To program accessory decoders on the main

```
SEL MODE 02:00PM  
SET CAB PARAMS
```

press **ENTER**. [7]
To setup macros (routing through turnouts)

```
SEL MODE 02:00PM  
PROG ACCESSORIES
```

press **ENTER**. [8]
To browse through all the advanced consists

```
SEL MODE 02:00PM  
PROGAM MACROS
```

in the system, press **ENTER** [9] To
program accessory decoders on the main

```
SEL MODE 02:00PM  
BROWSE CONSISTS
```

press **ENTER**. [10]

```
SEL MODE 02:00PM  
PROGRAM SIGNALS
```

PROGRAMMING MENUS

TABLE OF CONTENTS

The following is a chart of all of the programming modes and each section within each mode. Refer to the details in the following sections.

PROGRAMMING ON THE MAIN	48
WHAT TO PROGRAM	48
ADDRESS PROGRAMMING (OPTION 1)	48
CV PROGRAMMING (OPTION 2)	48
SET DECODER CONFIGURATION (OPTION 3)	48
SET MOTOR CONTROL PARAMETERS (OPTION 4)	50
SET UP DECODER OUTPUT/FUNCTION MAPPING (OPTION 5)	52
SET UP NCE LIGHTING EFFECTS (OPTION 6)	53
QSI PROGRAMMING (OPTION 8)	53
BINARY CV PROGRAMMING (OPTION 9)	54
BROADCAST PROGRAMMING (OPTION 0)	54
ASSIGNING A LOCO TO A CAB	55
ASSIGN THE LOCO	55
ASSIGN THE CAB	55
SET THE SYSTEM CLOCK	56
STOPPING THE CLOCK	56
SETTING 12 OR 24 HOUR MODE	56
ENTERING THE HOUR	56
ENTERING THE MINUTE	56
ENTERING THE RATIO	56
STARTING THE CLOCK	56
PROGRAMMING TRACK	57
PROGRAMMING OPTIONS	57
STANDARD PROGRAMMING (OPTION 1)	58
DECODER MANUFACTURER	58
DECODER VERSION	58
DISPLAY OF ACTIVE ADDRESS	58
SETTING UP BASIC DECODER CONFIGURATION (CV29)	59
DIRECTION BIT	59
SPEED STEPS	60
ANALOG MODE	60
SPEED TABLE SELECTION	60
ENABLE LONG OR SHORT ADDRESS	60
SETTING UP MOTOR CONTROL PARAMETERS	60
START VOLTAGE	61
MAXIMUM VOLTAGE	61
MID SPEED	61
ACCELERATION	61
DECELERATION	61
MOTOR PWM FREQUENCY	62
NCE TORQUE COMPENSATION KICK RATE	62
NCE TORQUE COMPENSATION KICK DEPTH	62
SET UP DECODER OUTPUT/FUNCTION MAPPING	63
CONFIGURATION VARIABLE (CV) PROGRAMMING (OPTION 1)	63
SET ANY CV (OPTION 2)	64
REGISTER PROGRAMMING (OPTION 3)	64
PAGED PROGRAMMING (OPTION 4)	65
DIRECT PROGRAMMING (OPTION 5)	65
SET UP NCE LIGHTING EFFECTS (OPTION 6)	65
RECOVERY PROGRAMMING (OPTION 7)	65
SETUP COMMAND STATION	66
DISPLAY SOFTWARE VERSION AND DATE	66

NUMBER OF STOP PACKETS	66
NUMBER OF TEMP PACKETS	66
NUMBER OF ACCESSORY PACKETS	66
NUMBER OF HORN OFF PACKETS	66
NUMBER OF PROGRAM PACKETS	67
TEST FOR LOCO IN USE	67
SEND FUNCTION COMMANDS TO CONSIST ADDRESS	67
CONSIST MOMENTUM	67
MOMENTUM MULTIPLIER	67
MOMENTUM DECELERATION RATE	67
EMERGENCY STOP LAYOUT SHUTDOWN	68
RADIO FIX ENABLE	68
AIU BROADCAST ENABLE	68
RS232 PORT BAUD RATE	68
SYSTEM RESET	68
FUNCTION REFRESH RATE	68
MEMORY BACKUP OPTIONS	69
HYPERTERMINAL SETTINGS FOR SYSTEM BACKUP	69
HIGHEST CAB TO PROGRAM ON MAIN	70
HIGHEST CAB TO ASSIGN LOCO	70
HIGHEST CAB TO SET CLOCK	70
HIGHEST CAB TO USE PROGRAM TRACK	70
HIGHEST CAB TO SET COMMAND STATION	70
HIGHEST CAB TO SET ITSELF	70
HIGHEST CAB TO PROGRAM ACCESSORIES	70
HIGHEST CAB TO PROGRAM MACROS	70
HIGHEST CAB TO PROGRAM SIGNALS	70
HIGHEST CAB TO PROGRAM CONSISTS	71
CLEAR ALL CONSISTS	71
CLEAR ALL CAB MEMORY	71
SET CAB PARAMETERS	72
NUMBER OF RECALLS	72
CLEAR RECALLS	72
ANALOG HORN CHANNEL	72
ANALOG AUX CHANNEL	72
ANALOG BIAS	72
ASSIGNING THE HORN/WHISTLE FUNCTION	72
ASSIGNING THE BELL FUNCTION	73
PROGRAM ACCESSORY DECODERS	74
PROGRAM MACROS	75
ENTER THE ACCESSORY ADDRESS/LINKING MACROS	75
BROWSE CONSISTS	77
PROGRAM SIGNAL DECODERS	78
PLAYABLE WHISTLE OR HORN	79

PROGRAMMING ON THE MAIN

Programming on the Main is also called Operations (OPS) Mode programming. OPS programming allows you to change parameters while the loco is on the main track (even while it's *running*). This does not affect other locomotives on the track. You can even change the locomotive address.

```
OPS PROG 02:00PM
PROG LOCO: 003
```

We first begin by telling the system which locomotive to program. If you want to program the locomotive you are currently operating just press **ENTER**. If you wish to program a different locomotive just enter its address at the above prompt.

WHAT TO PROGRAM

After determining which locomotive you wish to program you will see the following display. The Power Pro system provides 9 different OPs mode programming options.

```
LOC:1022 02:00PM
1=ADR 2=CV 3=CFG
```

The first three options are displayed. Press **ENTER** to see more options. For example: If you wish to set the locomotive address press 1, if you want to program CVs press 2.

Descriptions of each programming option are described below.

- 1 SET UP LOCOMOTIVE ADDRESS
- 2 CHANGE ANY CV IN THE DECODER
- 3 SET UP THE DECODER CONFIGURATION (CV29)
- 4 MOTOR CONTROL
- 5 FUNCTION MAP
- 6 NCE EFFECTS
- 7 Not Used
- 8 QSI SOUND
- 9 BIN CV

ADDRESS PROGRAMMING (Option 1)

This option provides a means by which to program the address of your locomotive. Most decoders allow programming of the locomotive address while on the mainline. The first thing to do is decide if you want to program a long or short address into the locomotive.

```
SET ADDR 03:38PM
1=LONG 2=SHORT
```

In DCC there are 2 kinds of addresses (loco numbers), long and short. Short addresses range from 1 to 127 and long addresses range from 0-9999. We normally recommend using long addresses for all your locomotives. Consists require the use of a short address so it is better to conserve short addresses by using long addresses for individual locomotives. Push the digit button that corresponds to the type of address you wish to program. You will then be presented with the display below.

```
SET ADDR 03:38PM
LONG ADDR: -
```

Enter the new address for the locomotive. The new address will be sent to the locomotive and you will be returned to the normal display with the locomotive selected and ready to run. Most decoders allow programming the address while on the mainline. If you are using a locomotive with a sound decoder from QSI you will need to turn off verbal programming acknowledgment (set CV62 to 0) for the address to be set properly. If your locomotive does not allow setting the address on the mainline you will need to set it on the programming track. You can press PROG/ESC to escape out of setting the address without affecting anything in the decoder. No commands are sent until you press **ENTER** after typing in the address.

CV PROGRAMMING (Option 2)

This option allows you to change *any* configuration variable (range of 1-999) in your decoder.

ENTER CONFIGURATION VARIABLE NUMBER

All configuration variables can be set while on the mainline. Just pressing **ENTER** without typing in a number will return you to the main OPS programming prompt. Pressing PROG/ESC will completely exit from programming and return you to the normal display.

```
PROG CV 02:00PM
ENTER CV NUM: _
```

ENTER THE VALUE

The value to be programmed into the CV should now be entered at the prompt below. Pressing **PROG/ESC** before or during number entry will completely exit from programming and return you to the normal display.

```
PROG CV 02:00PM
ENTER VALUE: _
```

SET DECODER CONFIGURATION (Option 3)

This option will setup the various decoder configuration parameters. There are six of these parameters squeezed into one CV. You will be asked a series of questions regarding the basic operation of the locomotive. If you are in doubt about the proper answer just press **ENTER** and you will usually be OK.

DIRECTION BIT - NORMAL OR REVERSE

Press **ENTER** for the locomotive to operate in the normal direction or press **1** to switch the direction of operation.

```
DIR BIT? 02:00PM
ENTER=NORM 1=REV
```

SPEED STEPS - 28 OR 14

Press **ENTER**. All decoders made since 1997 support 28 speeds. NOTE: If you are wondering how to set the decoder for 128 speed operation, you do not have to program anything. 128 speed mode is always enabled in decoders that support 128 speed step operation.

```
SPEED 02:00PM
ENTER=28 1=14 _
```

DC (Analog) MODE

Press **ENTER** to turn DC operation mode off, press **1** to turn DC mode on. We recommend leaving DC mode off for most layouts. This is to prevent all your locomotives from taking off at once in case of a failure in your power station or someone accidentally connecting the track to a DC power supply (it happens more often than you might think).

```
DC MODE 02:00PM
ENTER=NO 1=YES_
```

ADVANCED ACKNOWLEDGE

Press **ENTER** to turn Advanced Acknowledge mode off, press **1** to turn Advanced Acknowledge mode on.

```
ADV ACK? 02:00PM
ENTER=NO 1=YES _
```

NOTE: advanced acknowledgment is not operational in any decoders at this time as the NMRA has not defined how it is to work.

SPEED TABLE SELECTION

If the Standard Speed Table is to be used, press **ENTER**. If the Alternate (uploadable) Speed Table in the decoder is to be used, press **1**.

```
SPEEDTBL 02:00PM
ENTER=STD 1=ALT_
```

ENABLE LONG OR SHORT ADDRESS

The short address is used when operating on DCC systems that do not use long addresses.

```
ADDRESS 02:00PM
ENTER=S 1=LONG:_
```

SET MOTOR CONTROL PARAMETERS (Option 4)

This option can be used to setup the various locomotive motor speed control parameters. You can skip adjusting any of these parameters (CVs) by pressing **ENTER** without entering. The first adjustment is:

START VOLTAGE (CV2)

Start voltage is the amount of voltage the decoder sends to the motor when a speed step 1 command is sent to the locomotive. This is some extra voltage to help get the motor running. You can put in any value from 0-255. If you put in a value of 10 then 10/255 (about 4%) of the full motor voltage will be applied to the motor at speed step 1.

```
OPS PROG 11:22AM
START VOLTS: _
```

In most decoders the start voltage is added to each speed step. A good way to setup the Start Voltage is to first set your throttle to speed 1 then go into this Start Voltage programming and try different values until you get the desired starting speed. This approach can be used with most of the motor speed adjustments. You may exit programming at any time by pressing **PROG/ESC**.

MAXIMUM VOLTAGE (CV5)

This is the amount of voltage applied to the motor at full speed. A value of 255 means send the full available track voltage to the motor. Lower numbers will tell the decoder to

send proportionally less voltage when full speed is called for.

```
OPS PROG 11:22AM
MAX VOLTAGE: -
```

A value of 192 will cut the maximum speed to 192/255 (about 75%) of the track voltage. Most decoders interpret a value of 0 to mean 255.

MID SPEED VOLTAGE (CV6)

This is the amount of voltage applied to the motor when the middle speed step (14 or 64 depending on speed mode) is requested. A value of 128 means to send about ½ the available track voltage (128/255 of the voltage) to the motor.

```
OPS PROG 11:22AM
MID VOLTAGE: -
```

Lower or higher values will send proportionally higher or lower voltages at mid-speed. Most decoders interpret a value of 0 to mean 128.

ACCELERATION (CV3)

With this CV set to 0 the decoder will be in what is commonly called 'direct drive'. The decoder will instantly jump to the speed requested by the throttle. You can add momentum by adjusting this parameter.

```
OPS PROG 11:22AM
ACCELERATION: -
```

A value of 1 will force a delay of .007 seconds between speed steps in 128 speed mode (.032 seconds in 28 speed mode). This is equivalent to .896 seconds (.007 x 128 speeds) to go from speed 0 to full speed. A value of 10 will yield about 8.9 seconds to full speed.

DECELERATION (CV4)

Deceleration works to delay the slowing down of the motor with the same timing as acceleration.

```
OPS PROG 11:22AM
DECELERATION: -
```

MOTOR PWM FREQUENCY (CV9)

DCC decoders almost always drive the motor of the locomotive with Pulse Width Modulation (PWM). This is a series of full voltage pulses that vary in width from very narrow for low motor speed to very wide providing higher power to the motor. How often the pulses are sent is called the frequency.

```
OPS PROG 11:22AM
PWM FREQ: -
```

The frequency is adjustable on some decoders. Settings for this CV vary so consult your decoder manual for the proper value. If your decoder is capable of 'silent' operation usually a 0 is required.

NCE TORQUE COMPENSATION KICK RATE (CV116)

Newer NCE decoders provide Torque Compensation for smooth low speed operation. Torque Compensation gives a steady stream of 'kicks' to the motor when running at very low speeds. You can adjust how *often* the motor is kicked (Kick Rate) and how *hard* it is kicked (Kick Strength). CV116 controls the rate.

OPS PROG 11:22AM
KICK RATE: -

The typical value is 2-4 with the maximum practical value of about 6. The smaller the number the more often the motor gets a brief voltage kick. A value of 0 turns off the kick. A value of 1 gives continuous kicks to the motor (not very useful). When using Torque Compensation set the Start Voltage to 0 for best operation.

NCE TORQUE COMPENSATION KICK DEPTH (CV117)

This is how hard the motor is kicked at low speed. Typical values range from 1 to 40. High quality motors (Kato) need very little kick strength where lower quality motors such as old Athearn and LifeLike need relatively large values (30-50) for slow speed crawling,

OPS PROG 11:22AM
KICK DEPTH: -

Tips for setting up T/C (Torque Compensation):

- Start by setting the locomotive speed to 1 on your throttle.
- Set the Kick Rate to 4.
- Set the Kick Depth to 20 then adjust this value up or down until the locomotive just barely crawls.

It may be easier to set the T/C with the body shell removed from the locomotive so that you can see the flywheels turn. When you get fairly good slow speed operation go back to the Kick Rate and try bumping the value up by 1 or 2 to see if the operation improves.

DECODER OUTPUT/FUNCTION MAPPING (Option 5)

General Discussion of function mapping

Function mapping is used to customize which lighting outputs (or sound effects) are controlled by which function keys on your handheld throttle. Each function command, F0 through F12, is assigned a unique CV that allows the corresponding function command to be redirected to up to 14 different lighting outputs or sound effects.

A single function key can control more than one output if desired.

It is also possible for one output to be controlled by multiple function keys. In this case, the output will be turned on when any of the corresponding function keys are active.

That output will turn off only when all relevant inputs have also been turned off.

Note that all function commands cannot be mapped to all outputs. The LCD display on your ProCab will indicate only those outputs that can be mapped to each function command.

The F0 function has two CVs - one for forward direction and one for reverse. Function outputs mapped to these CVs will be directional unless the same output is mapped to both CVs. CVs 33 and 34 are both for the F0 function.

On NCE decoders CV33 and CV34 do not provide directionality (see SETUP NCE LIGHTING EFFECTS below) but otherwise operate the same as above. With NCE decoders direction of operation for function outputs is provided by the lighting effects CVs 120 through 127.

Lenz and TCS decoders do not follow NMRA standard function mapping procedures. When you select function mapping you are prompted for the function number to map.

PRESS FUNCTION
NUMBER TO MAP

The top line of the LCD displays the function number and the output numbers that can be controlled by the function.

```
F2      12345678
OUTPUTS: 4
```

Pressing a digit key will enable the output on the decoder when the function is activated. Pressing the same digit key again will disable the output. In the display above the 4 key has been pressed so that output number 4 will activate when ever the F2 button is pressed on your handheld cab. If you were to press another digit such a 6, both output 4 and output 6 will be controlled by pressing F2.

When mapping functions higher than 3, the top line of the LCD will use small numbers to indicate the output numbers 10 through 14. To enable/disable these high numbers press the digit key that is 10 less than the output number. Example: press 0 for output 10, 1 for output 11, etc. Pressing PROG/ESC will exit from mapping at any time.

SETUP NCE LIGHTING EFFECTS (Option 6)

You can use this option to customize the lighting effects for your NCE decoder equipped locomotives. This programming option will only work with NCE decoders.

```
NCE EFX 07:04
OUTPUTNUMBER: -
```

Function outputs are numbered from 1 to 14. Do not confuse *Output* numbers with *Function* numbers. The headlight is always output 1 and the reverse light is usually output 2. You are prompted for the output number to setup. Press the output number followed by ENTER.

```
OUTPUT NUMBER:03
USE THUMBWHEEL
```

Use the thumbwheel or up/down speed buttons to scroll through the different lighting effect options. Press ENTER when you get the one you want.

```
DIR OF OPERATION
1=FW 2=RV 3=BOTH
```

Next press 1,2 or 3 to select the 'directionality' of the output. If you want the output active only in the forward direction of travel - press 1. Press 2 for the effect to operate only when travelling in reverse. 3 activates the output no matter which direction the locomotive is travelling.

```
REGULAR BULB OR
LED 1=BULB 2=LED
```

Last, press 1 if the output has a regular incandescent bulb attached. Press 2 if the output has an LED connected. LEDs behave differently when dimmed than incandescent bulbs. Pressing 1 or 2 informs the decoder which set of lighting characteristics to use for this output.

QSI PROGRAMMING (Option 8)

QSI sound decoders use indexed programming of CV51,CV52,and CV56. You are asked for an index number before you are asked for the CV value. CV49 is then automatically set with the index value before the original CV is set with the desired data. When programming CV56 you are asked for primary and secondary index numbers before you are asked for the CV value. CV49 and CV50 are then automatically set with the index numbers before CV53 is set with the desired data. All other CV's are programmed in the normal manner.

BINARY CV PROGRAMMING (Option 9)

Use this option if you need to build up the value for a CV bit-by-bit. Enter the CV number you wish to program.

```
BIN PROG 02:10AM
ENTER CV NUM: -
```

Then press bit number (top line of LCD has bit numbers) to toggle the corresponding individual bits on the lower line of the LCD that make up a binary byte. In the example below the 1,3 and 7 keys have been pressed to set the corresponding bits in the byte. To set the value of a bit back to 0 press the bit number again.

```
CV: 060 76543210
BITS: 10001010
```

When you get the value built up to the number you desire, press **ENTER** to program the CV.

BROADCAST PROGRAMMING (Option 0)

This forces the OPs programming address to short address 0. Use of this feature can be very dangerous as it **"WILL"** program **ALL** decoders on the layout at once.

The system will force you to have a valid loco address selected before you can enter PROGRAM ON THE MAIN. When you select Option 0 the top line of the LCD will display

```
LOC:000 02:10AM
1=ADR 2=CV 3=CFG
```

indicating you are now in Broadcast programming mode.

Use caution - ALL programming mode options are available to you at this point.

When you exit the PROGRAM ON THE MAIN short address 0 will still be selected so you must enter a valid address to perform any normal system tasks.

ASSIGNING A LOCO TO A CAB (shortcut = PROG 2)

This selection passes a loco from one cab to another. This is especially useful when the other operator is a novice or has a Basic Cab. The locomotive/consist is passed to the assigned cab and the locomotive/consist controlled by the other cab is passed back to the original cab. In effect the locomotives controlled by the cabs are "swapped". This way you will not accidentally 'lose' a locomotive in the system.

ASSIGN THE LOCO

Enter the loco/consist number you want to assign to another cab, then press **ENTER**. If you want to assign the loco you are currently running just push **ENTER**.

```
ASSIGN    02:00PM  
WHICH LOCO: _003
```

ASSIGN THE CAB

You need to know the address of the cab you want to 'receive' the loco you are assigning. Enter the Cab number then press **ENTER**.

```
LOC:1234 02:00PM  
TO WHICH CAB? _
```

This operation is also useful to transfer an old style consist to a smaller cab without the capability of setting up consists.

SET THE SYSTEM CLOCK (shortcut = PROG 3)

This allows the operator to start/stop the clock, set it, choose 12 or 24 hour operation, or change the fast clock ratio.

STOPPING THE CLOCK

Press **1** to stop the clock, press **ENTER** to leave the clock running and continue with clock programming. If the clock is already stopped, you will be prompted to start it.

```
STOP?    02:00PM  
ENTER=NO 1=STOP
```

SETTING 12 or 24 HOUR MODE

Press **1** for 12 hour mode, press **ENTER** for 24 hour mode.

```
SET TIME 02:00PM  
1=12HR  2=24HR  _
```

ENTERING THE HOUR

Enter the starting hour in 24 hour format. For times in the A.M. use 0 to 11. For times in the P.M. use 12 to 23. Press **ENTER**.

```
SET TIME 02:00PM  
ENTER HOURS:  _
```

ENTERING THE MINUTE

Enter the starting minute. Use 0 through 59. Press **ENTER**.

```
SET TIME 02:00PM  
ENTER MINUTES:  _
```

ENTERING THE RATIO

Enter the ratio that the clock should run at with 1 being the normal speed. The ratio can be any number from 1 (1:1) to 15 (15:1). Press **ENTER**.

```
SET TIME 02:00PM  
ENTER RATIO:  _
```

STARTING THE CLOCK

If the clock was stopped, entering SET THE SYSTEM CLOCK will display this screen to let you start (or restart) the clock. Press **1** to start the clock, press **ENTER** to leave the clock stopped and continue with clock programming (see above).

```
START?    02:00PM  
ENTER=NO 1=START
```

USE PROGRAM TRACK (shortcut = PROG 4)

Locomotive decoders remember their operating parameters such as the address, start voltage and lighting effect setups in the decoder's memory. Each storage location is called a Configuration Variable, or CV for short. There is usually a CV for each programmable parameter. The Power Pro allows you to change any or all of the CVs in the loco, including the address. These variables will remain as programmed until you change them. Programming on the Main (covered earlier in this manual) is very useful for modifying one, two or a few CVs while the locomotive is out on the layout. The Program Track is useful for more intensive initial setup of a locomotive. The biggest advantage of the program track is the ability to read out the values of CVs already setup in the locomotive decoder.

Please note: The programming track does not supply enough power to run your locomotive. It has enough power to program the decoder but not enough to cause damage to a miswired decoder or run a motor. You can only run trains on the main track. We recommend that you always try out a newly installed decoder on the Program Track first. If you can 'read' a decoder on the Program Track you can reasonably expect that it is wired correctly and working properly.

PROGRAMMING OPTIONS

Just as with Programming on the Main there are several menu options you can select. The Power Pro system provides 7 different Program Track options. Descriptions of each programming option are described below.

- 1 = STANDARD DECODER SETUP, including
Address, Configuration and Function Mapping.
- 2 = CHANGE ANY CV IN THE DECODER
Reads and programs CVs 1-999.
- 3 = SET UP THE DECODER CONFIGURATION (CV29)
Change direction of operation, analog mode on/off, 14 or 28 speed mode,
long or short address, factory or custom speed table.
- 4 = PAGED MODE PROGRAMMING
Force the system to use paged mode programming.
- 5 = DIRECT MODE PROGRAMMING
Force the system to use direct mode programming.
- 6 = NCE EFFECTS
Setup NCE lighting effects.
- 7 = RECOVERY PROGRAMMING
Reprograms selected decoder CVs in an attempt to get an 'insane' decoder
back to somewhat normal operation.

The first three options are displayed below. Press ENTER to see more options. For example: If you wish to program the "Standard" locomotive parameters, press 1, if you want to program decoder CVs press 2.

```
PROG TRK 02:00PM  
1=STD 2=CV 3=REG
```

This screen allows the user to select the method of programming to suit the decoder you are using. There are 7 programming options when using the program track. STD programming (option 1) will automatically determine whether to use the Direct or Paged

programming methods. Paged programming is used by older decoders and can take up to fifteen seconds to read each CV. Direct mode is newer and generally reads CVs in one to two seconds. For various reasons you may wish to 'force' the programming method to one or the other types. You can press 4 for paged programming or press 5 for direct programming. Standard sets the most common decoder parameters.

STANDARD PROGRAMMING (Option 1)

This option automatically determines if the decoder supports Direct or Paged programming and uses the appropriate method for subsequent programming operations. Use this option for initial setup of your decoder. You will be advised about the manufacturer and the version of the decoder software. You will also be able to setup the decoder address, basic configuration, motor control, NMRA standard function mapping and finally any additional CVs you may wish to program.

DECODER MANUFACTURER

This is the NMRA assigned manufacturer number of the decoder. All NCE decoders respond with 11. Press ENTER to continue.

```
MAIN OFF 02:00PM
MANUFACTURER:011
```

You may get this error message:

```
MAIN OFF 02:00PM
CAN NOT READ CV
```

This means the decoder did not respond to attempts to read this parameter value in the decoder. There are several things that can cause a failure to read: a miswired decoder, broken or missing track pickup wires, the motor is not connected to the decoder, defective decoder, wires to the program track are disconnected, etc. All decoders require that a motor (or similar 'load') be connected to the decoder for proper reading on the program track. Decoders that draw too much power from the program track can also cause this message. Most sound decoders draw large amounts of current. The Power Pro can supply the NMRA limit of ¼ Amp of current for initial 'charging' of these decoders and 160mA of continuous current for normal program track operations. If the decoder exceeds these capabilities you will get the error message. Press ENTER to continue. You will probably still be able to program by ignoring the error. Press ENTER, then proceed in the usual manner.

DECODER VERSION

This display indicates the programming method in use on the top line and the version number of the software in the decoder on the bottom line. Press ENTER to continue.

```
DIR MODE 02:00PM
DECODER VER: 041
```

DISPLAY OF ACTIVE ADDRESS

The current active address (long or short) is indicated on the top line of the display. If you wish to change the decoder address press 1. Any other button will skip programming the address and continue standard programming.

```
ACTIVE ADR:SHORT
SETUP ADDR 1=YES
```

ENTERING THE DECODER (LOCOMOTIVE) ADDRESS

The short address is displayed first. If you wish to change it type in the new address and press **ENTER**. If you wish to keep it unmodified just press **ENTER** to skip to the display of the long address.

```
ACTIVE ADR: SHORT
SHORT ADDR: 003
```

If you put in a new address you will see the following LCD screen asking if you wish to make this address the primary address. Only one address can be the primary address – the long or the short. You cannot have both active at the same time. The decoder will not allow it.

The long address is displayed next. If you wish to change it type in the new address and press **ENTER**. If you wish to keep it unmodified just press **ENTER** to skip to continue programming.

```
SETUP ADDRESS
LONG ADDR: 1044
```

If you enter a new long address you will be asked if you want to activate it. Press 1 for yes. Any other key continues with programming.

```
ACTIVATE
THIS ADDR: 1=YES
```

NOTES ON ADDRESSES:

The short address is available for use on layouts using short addresses. If the short address is to be the primary address you should use the last two digits of the loco number. Short addresses range from 1 to 127.

For the long address, any number from 0 through 9999 can be used. You need to distinguish long addresses from short when assigning an address below 128 by entering a zero as the first character.

Example: short address = 64
long address (below 128) = 064

We recommend that if a long address is used, leave the short address at 3. This has two advantages. One, if the long address is forgotten, the short address is always 3. Two, advanced consist addresses share the same 1 to 127 address range available to the short addresses. Using the same address for an Advanced Consist and another existing loco will cause unpredictable results.

SETTING UP BASIC DECODER CONFIGURATION (CV29)

This option will setup various decoder configuration parameters. There are six of these parameters squeezed into one CV. Press 1 if you want to set these parameters. Any other key will skip to Motor Control Setup.

```
SET CFG?
ENTER=NO 1=YES
```

You will be asked a series of questions regarding the basic operation of the locomotive. If you are in doubt about the proper answer just press enter and you will usually be OK.

DIRECTION BIT - NORMAL OR REVERSE

Press **ENTER** for the locomotive to operate in the normal direction or press **1** to switch the direction of operation.

```
DIR BIT? 02:00PM
ENTER=NORM 1=REV
```

SPEED STEPS - 28 OR 14

If the decoder in this locomotive is an early 14 step decoder then press 1. (all decoders made since 1997 support 28 speeds). NOTE: If you are wondering how to set the decoder for 128 speed operation, you do not have to program anything. 128 speed mode is always enabled in decoders that support 128 speed step operation.

```
SPEED 02:00PM
ENTER=28 1=14 _
```

DC (Analog) MODE

Press **ENTER** to turn DC operation mode off, press 1 to turn DC mode on. We recommend leaving DC mode off for most layouts.

```
DC MODE 02:00PM
ENTER=NO 1=YES _
```

This is to prevent all your locomotives from taking off at once in case of a failure in your power booster or someone accidentally connecting the track to a DC power supply (it happens more often than you might think).

ADVANCED ACKNOWLEDGE

Press **ENTER** to turn Advanced Acknowledge mode off, press 1 to turn Advanced Acknowledge mode on.

```
ADV ACK? 02:00PM
ENTER=NO 1=YES _
```

NOTE: advanced acknowledgment is not operational in any decoders at this time as the NMRA has not defined how it is to work.

SPEED TABLE SELECTION

If the Standard Speed Table is to be used, press **ENTER**. If an Alternate (uploadable) Speed Table in the decoder is to be used, press 1.

```
SPEEDTBL 02:00PM
ENTER=STD 1=ALT_
```

ENABLE LONG OR SHORT ADDRESS

The short address is used when operating on DCC systems that do not use long address.

```
ADDRESS 02:00PM
ENTER=S 1=LONG:_
```

SETTING UP MOTOR CONTROL PARAMETERS

This option can be used to setup the various locomotive motor speed control parameters. You can skip adjusting any of these parameters (CVs) by pressing **ENTER**. Press 1 to adjust motor control.

```
SET UP MOTOR
CONTROL? 1=YES
```

The first adjustment is:

START VOLTAGE (CV2)

Start voltage is the amount of voltage the decoder sends to the motor when a speed step 1 command is sent to the locomotive. This is some extra voltage to help get the motor running. You can put in any value from 0-255. If you put in a value of 10 then 10/255 (about 4%) of the full motor voltage will be applied to the motor at speed step 1. In most decoders the start voltage is added to each speed step.

```
OPS PROG 11:22AM
START VOLTS: -
```

A good way to setup the Start Voltage is to first set your throttle to speed 1 then go into this Start Voltage programming and try different values until you get the desired starting speed. This approach can be used with most of the motor speed adjustments. You may exit programming at any time by pressing PROG/ESC.

MAXIMUM VOLTAGE (CV5)

This is the amount of voltage applied to the motor at full speed. A value of 255 means send the full available track voltage to the motor. Lower numbers will tell the decoder to send proportionally less voltage when full speed is called for.

```
OPS PROG 11:22AM
MAX VOLTAGE: -
```

A value of 192 will cut the maximum speed to 192/255 (about 75%) of the track voltage. Most decoders interpret a value of 0 to mean 255.

MID SPEED VOLTAGE (CV6)

This is the amount of voltage applied to the motor when the middle speed step (14 or 64 depending on speed mode) is requested. A value of 128 means to send about ½ the available track voltage (128/255 of the voltage) to the motor.

```
OPS PROG 11:22AM
MID VOLTAGE: -
```

Lower or higher values will send proportionally higher or lower voltages at mid-speed. Most decoders interpret a value of 0 to mean 128.

ACCELERATION (CV3)

With this CV set to 0 the decoder will be in what is commonly called 'direct drive'. The decoder will instantly jump to the speed requested by the throttle. You can add momentum by adjusting this parameter.

```
OPS PROG 11:22AM
ACCELERATION: -
```

A value of 1 will force a delay of .007 seconds between speed steps in 128 speed mode (.032 seconds in 28 speed mode). This is equivalent to .896 seconds (.007 x 128 speeds) to go from speed 0 to full speed. A value of 10 will yield about 8.9 seconds to full speed.

DECELERATION (CV4)

Deceleration works to delay the slowing down of the motor with the same timing as acceleration.

```
OPS PROG 11:22AM
DECELERATION: -
```

MOTOR PWM FREQUENCY (CV9)

DCC decoders almost always drive the motor of the locomotive with Pulse Width Modulation (PWM). This is a series of full voltage pulses that vary in width from very narrow for low motor speed to very wide providing higher power to the motor.

```
OPS PROG 11:22AM
PWM FREQ: -
```

How often the pulses are sent is called the frequency. The frequency is adjustable on some decoders. Settings for this CV vary so consult your decoder manual for the proper value. If your decoder is capable of 'silent' operation usually a 0 is required.

NCE TORQUE COMPENSATION KICK RATE (CV116)

If your decoder supports NCE torque compensation this menu item will be displayed. If not you will be sent to SET UP FUNCTION MAPPING.

NCE decoders since version 3.5 provide Torque Compensation for smooth low speed operation. Torque Compensation gives a steady stream of 'kicks' to the motor when running at very low speeds. You can adjust how *often* the motor is kicked (Kick Rate) and how *hard* it is kicked (Kick Strength).

```
OPS PROG 11:22AM
KICK RATE: -
```

CV116 controls the rate. The typical value is 2-4 with the maximum practical value of about 6. The smaller the number the more often the motor gets a brief voltage kick. A value of 0 turns off the kick. A value of 1 gives continuous kicks to the motor (not very useful). When using Torque Compensation set the Start Voltage to 0 for best operation.

NCE TORQUE COMPENSATION KICK DEPTH (CV117)

This is how hard the motor is kicked at low speed. Typical values range from 1 to 40. High quality motors (Kato) need very little kick strength where lower quality motors such as old Athearn and LifeLike need relatively large values (30-50) for slow speed crawling.

```
OPS PROG 11:22AM
KICK DEPTH: -
```

Tips for setting up T/C (Torque Compensation):

- Start by setting the locomotive speed to 1 on your throttle.
- Adjust the Kick Rate to 4.
- Set the Kick Depth to 20 then adjust this value up or down until the locomotive just barely crawls.

It may be easier to set the T/C with the body shell removed from the locomotive so that you can see the flywheels turn. When you get fairly good slow speed operation go back to the Kick Rate and try bumping the value up by 1 or 2 to see if the operation improves.

SETUP DECODER OUTPUT/FUNCTION MAPPING

General Discussion of function mapping

Function mapping is used to customize which decoder lighting outputs (or sound effects) are controlled by which function keys on your handheld throttle. Each function command, F0 through F12, is assigned a unique CV that allows the corresponding function command to be redirected to up to 14 different lighting outputs or sound effects. A single function key can control more than one output if desired. It is also possible for one output to be controlled by multiple function keys. In this case, the output will be turned on when any of the corresponding function keys are active. That output will turn off only when all relevant inputs have also been turned off.

Note that all function commands cannot be mapped to all outputs. The LCD display on your ProCab will indicate only those outputs that can be mapped to each function command.

The F0 function has two CVs - one for forward direction and one for reverse. Function outputs mapped to these CVs will be directional unless the same output is mapped to both CVs. CVs 33 and 34 are both for the F0 function. On NCE decoders CV33 and CV34 do not provide directionality (see SETUP NCE LIGHTING EFFECTS below) but otherwise operate the same as above. With NCE decoders direction of operation for function outputs is provided by the lighting effects CVs (120 through 127). Lenz and TCS decoders do not follow NMRA standard function mapping procedures.

When you select function mapping you are prompted for the function number to map.

```
PRESS FUNCTION
NUMBER TO MAP
```

The top line of the LCD displays the function number and the output numbers that can be controlled by the function. The lower line displays the currently controlled outputs. Pressing a digit key will enable the output on the decoder when the function is activated. Pressing the same digit key again will disable the output. In the display below, the 4 key has been pressed so that output number 4 will activate when ever the F2 button is pressed on your handheld cab. If you were to press another digit such a 6, both output 4 and output 6 will be controlled by pressing F2.

```
F2      12345678
OUTPUTS: ---4----
```

When mapping functions higher than 3, the top line of the LCD will use small numbers to indicate the output numbers 10 through 14. To enable/disable these high numbers press the digit key that is 10 less than the output number.
Example: press 0 for output 10, 1 for output 11, etc.

Pressing **PROG/ESC** will exit from mapping at any time.

CV PROGRAMMING

This option allows you to change *any* configuration variable (range of 1-999) in your decoder. Press PROG/ESC at any time to exit.

ENTER CONFIGURATION VARIABLE NUMBER

All configuration variables can be set while on the mainline. Just pressing **ENTER** without typing in a number will return you to the main OPS programming prompt. Pressing **PROG/ESC** will completely exit from programming and return you to the normal display.

```
PROG CV 02:00PM
ENTER CV NUM: _
```

ENTER THE VALUE

The value to be programmed into the CV should be entered at the prompt below. Pressing PROG/ESC before or during number entry will completely exit from programming and return you to the normal display.

```
PROG CV 02:00PM
ENTER VALUE: _
```

SET ANY CV (Option 2)

This option allows you to change *any* configuration variable (range of 1-999) in your decoder. Press **PROG/ESC** at any time to exit.

```
PROG CV 02:00PM
ENTER CV NUM: _
```

ENTER CONFIGURATION VARIABLE NUMBER

All configuration variables can be set while on the mainline. Just pressing **ENTER** without typing in a number will return you to the main OPS programming prompt. Pressing **PROG/ESC** will completely exit from programming and return you to the normal display.

ENTER THE VALUE

The value to be programmed into the CV should be entered at the prompt below. Pressing PROG/ESC before or during number entry will completely exit from programming and return you to the normal display.

```
PROG CV 02:00PM
ENTER VALUE: _
```

REGISTER PROGRAMMING (Option 3)

The programming section is included to make setting of MRC and old Lenz Decoders possible. Refer to the document that is included with the Decoder for register information.

ENTER THE REGISTER TO PROGRAM

Enter the register number and press **ENTER**. The current value of that register will be read from the Decoder and displayed. If you wish to modify the value type in a new number and press **ENTER**.

```
PROG TRK
REGISTER? _
```

If you want to keep the value just press **ENTER** without putting in any numbers. Registers used with decoders that require register programming

CV #	Description	Register #
1	Short Address (0-99 valid)	1
2	Start Voltage (0-15 valid)	2
3	Acceleration (0-15 valid)	3
4	Deceleration (0-15 valid)	4
29	Configuration byte (set to 6)	5

PAGED PROGRAMMING (Option 4)

Option 4 forces the system to use Paged mode while doing Standard Programming. Almost all decoders support Paged Mode.

DIRECT PROGRAMMING (Option 5)

Option 5 forces the system to use Direct mode while doing Standard Programming. Older decoders (built prior to 1/1/2001) do not support Direct Mode programming.

SETUP NCE LIGHTING EFFECTS (Option 6)

You can use this option to customize the lighting effects for your NCE decoder equipped locomotives. This programming option will only work with NCE decoders.

```
NCE EFX 07:04AM
OUTPUT NUMBER:
```

Function outputs are numbered from 1 to 14. Do not confuse *Output* numbers with *Function* numbers. The headlight is always output 1 and the reverse light is usually output 2. You are prompted for the output number to setup. Press the output number followed by **ENTER**.

Use the thumbwheel or up/down speed buttons to scroll through the different lighting effect options. Press **ENTER** when you get the one you want.

```
OUTPUT NUMBER:03
USE THUMBWHEEL
```

Next press 1,2 or 3 to select the 'directionality' of the output. If you want the output active only in the forward direction of travel - press 1. Press 2 for the effect to operate only when travelling in reverse. 3 activates the output no matter which direction the locomotive is travelling.

```
DIR OF OPERATION
1=FW 2=RV 3=BOTH
```

Last, press 1 if the output has a regular incandescent bulb attached. Press 2 if the output has an LED connected. LEDs behave differently when dimmed than incandescent bulbs. Pressing 1 or 2 informs the decoder which set of lighting characteristics to use for this output.

```
REGULAR BULB OR
LED 1=BULB 2=LED
```

RECOVERY PROGRAMMING (Option 7)

The programming section is included to allow the user to set *all* registers of the Decoder to the values that were programmed into it at the factory.

```
RECOVERY
PROGRAM 1=YES
```

RECOVERY PROGRAM

Press 1 to enter Recovery mode. This will reprogram NCE decoders (and most others) to their original factory values. But will set addresses, motor control CVs and Function Mapping CVs to a useful state so that you can get control of a decoder. As each CV is programmed the CV number is displayed.

SETUP COMMAND STATION (Shortcut = PROG 5)

This allows the operator to view the Command Station's version number and set various system (not decoder) parameters. If you press "28882" at the "SET CMD STATION" prompt the command station will be reset to all original factory settings.

DISPLAY SOFTWARE VERSION AND DATE

This screen is important when the time comes to call or write about a question or a problem.

```
VERSION: 01:30AM  
WED MAR 1 2007
```

The following screens are available should a need arise to change any of the factory settings. There is probably no reason to ever change these settings. If you get things REALLY messed up you can reset the system to original factory settings (see paragraph above).

NUMBER OF STOP PACKETS

This adjusts how many times a stop command is sent to the Loco. If you have a large layout or run more than about 40 different locomotives in a session we recommend setting this to 8. This will automatically purge non-necessary speed 0 commands from being sent to the track increasing system response to throttle commands.

```
NUMBER 02:00PM  
OF STOP PKTS 008
```

If set to zero all speed 0 commands will continue to be circulated for every locomotive that has been controlled (but now is stopped) since the system was last turned on. Factory default is 8. Press ENTER to skip setting this parameter.

NUMBER OF TEMP PACKETS

This adjusts the number of Function control commands that are sent when a Function control button is pressed. Factory default is 5. Press ENTER to skip setting this parameter.

```
NUMBER 02:00PM  
OF TEMP PKTS 005
```

NUMBER OF ACCESSORY PACKETS

This adjusts the number of accessory control commands sent when an accessory or signal is controlled. Factory default is 4. Press ENTER to skip setting this parameter.

```
NUMBER 02:00PM  
OF ACC PKTS: 004
```

NUMBER OF HORN OFF PACKETS

This adjusts the number of times a "horn off" packet is sent when the HORN button is released. The factory default is 2 but can be set as high as 16. Press ENTER to skip setting this parameter.

```
NUMBER 02:00PM  
HORN OFF PKT 002
```

NUMBER OF PROGRAM PACKETS

This adjusts the number of times a programming command is sent when programming a locomotive on the mainline. Factory default is 4. Press **ENTER** to skip setting this parameter.

```
NUMBER    02:00PM
OF PROG PKTS 004
```

TEST FOR LOCO IN USE

If set to YES, a warning will be issued if you select a loco that is in use by someone else. If set to NO, no warning is issued. Factory default is no. Press **ENTER** to skip setting this parameter.

```
TEST FOR LOCO IN
USE?      1=Y 0=N 0
```

SEND FUNCTION COMMANDS TO CONSIST ADDRESS

Function commands are normally sent to the lead loco of an advanced consist. They can also be sent to the consist address so that other locomotives in consist can react to these commands if desired. The factory default is yes. Press **ENTER** to skip setting this parameter.

```
SEND FUNCTION TO
CON?      1=Y 0=N 1
```

CONSIST MOMENTUM

You can disable the momentum button on all handheld cabs that are operating a consist. The buttons are enabled by factory default. Press **ENTER** to skip setting this parameter.

```
SEND FUNCTION TO
CON?      1=Y 0=N 1
```

MOMENTUM MULTIPLIER

When you press the MOMENTUM button you are prompted for a single digit indicating how much momentum you want for the loco/consist you are controlling. Momentum CVs have a range of 0-255 while the button asks for values from 0-9.

```
MOMENTUM BUTTON
MULTIPLIER: 08
```

The value you enter for the momentum button is multiplied by this parameter (factory default of 8) and sent to CV3 in the locomotive. This parameter adjusts the multiplication factor. You can set it from 0-25. Press **ENTER** to skip setting this parameter.

MOMENTUM DECELERATION RATE

The deceleration rate (CV4) when pressing the momentum button can be either half the value sent for acceleration (CV3) or the full value sent to CV3. Factory default is ½. Press **ENTER** to skip setting this parameter.

```
MOMEN DECEL RATE
1=FULL 0=HALF 0
```

EMERGENCY STOP LAYOUT SHUTDOWN

When you press the Emergency Stop button three times the layout power will be shut down and the address of the cab that shutdown the layout is broadcast to all other cabs. Only the cab that shut down the layout can start it up again by pressing ENTER. The shutdown can be disabled. The factory default is enabled. Press **ENTER** to skip setting this parameter.

```
ESTOP      SHUTDOWN
ENABLE 1=Y 0=N 1
```

RADIO FIX ENABLE

If on, steps are taken in the command station to prevent runaways when using radio cabs. The command station notices if speed buttons or a pot is being used on a cab by cab basis. If speed buttons are in use a bit is set and any "full speed" pot commands (the most common kind of erroneous radio command) are ignored thus preventing most runaways.

```
RADIO FIX
ENABLE 1=Y 0=N 1
```

You may need to disable the "fix if you are using a CAB04e with both "halves" of the cab set to the same cab address AND one half is set to yard mode while the other is set to normal mode or the ProCab set to yard mode. If you have an older ProCab with a potentiometer (1994-1997) you will probably have to disable this feature. It is on by factory default. Press **ENTER** to skip setting this parameter.

AIU BROADCAST ENABLE

The system can be set to have any connected AIU (Auxiliary Input Unit) automatically outputs its status via the RS232 port on the system box whenever an AIU input changes. This is disabled by default. Press **ENTER** to skip setting this parameter.

```
AIU      BROADCAST
ENABLE 1=Y 0=N 0
```

RS232 PORT BAUD RATE

You can set the system box RS-232 Baud Rate to 9600, 19,200 or 38,400 bits per second. Press the appropriate number to select the baud rate you desire. Factory default is 9600. Press **ENTER** to skip setting this parameter.

```
BAUD RATE 1=9600
2=19.2    3=38.4 1
```

RESET SYSTEM

Selecting this option will reset the system box back to original factory settings. You are asked to press 2 different buttons to make sure you really want to reset. All consist, macros and system set up parameters will be lost. Press **ENTER** to skip setting this parameter.

```
RESET      SYSTEM?
PRESS 6 FOR YES
```

FUNCTION REFRESH

This parameter enables Function (F0-F12) commands to be repeated on the rails after the "normal" number (TEMP PKTS... see TEMP PKTS above) of commands are sent. If non-zero, Function Group 1, Function Group 2 and Function Group 3 commands are

generated and sent out over the rails for the current active locomotive on each cab. The rate of sending these packets is approximately $.004 * n$ seconds (where $n = \text{value}$). Example: $n = 250$ refreshes all function group one packets about once each second. This should only be used when using Decoders (such as LENZ and TCS) that do not remember their Function status after a power interruption. All NCE and some premium Digitrax decoders remember their function status.

FUNCTION REFRESH
ENGAGE 1=Y 0=N

If you use these brands of decoders exclusively you do not need to set this to anything other than zero. It is recommended that this value be set above 400, numbers below 100 will not be accepted. Factory default is 0. Press **ENTER** to skip setting this parameter.

MEMORY BACKUP OPTIONS

You can backup the memory of your Power Pro to a computer using three options. You must connect your Power Pro to a computer using and RS-232 cable or RS-232 to USB cable to backup your system memory.

Most PCs are supplied with a program called Hyperterminal that can be used to capture setup data from the Power Pro system memory.

HYPERTERMINAL SETTINGS FOR SYSTEM BACKUP:

CONNECT TO -> CONFIGURE menu

9600 or 19200 baud (38400 only works right on some computers)
No parity
8 data bits
1 Stop bit
Flow Control - none

SETTINGS -> TERMINAL MODE

ANSI

SETTINGS -> ASCII setup

Echo typed characters locally
Append line feeds to incoming line ends
Line Delay: 10mS

Use "Capture Text" to receive backup data and save it to the PC disk.

There are three backup options:

Macro backup - saves all 256 macros.

5120 memory locations from 0xC800 to 0xDBFF

System backup - saves the system setup (SET CMD STA menus stuff)

80 memory locations from 0xDC00 to 0xDC4F

Consist backup - saves the advanced consist tables

1536 memory locations from 0xF500 to 0xFAFF

The data is sent as an ASCII file to the terminal program.

Format for the data is:

:aaaa dddd dddd dddd dddd (macro and consist data) or

:aaaa dd dd dd dd dd dd dd (system data)

:aaaa = RAM address in hex (high byte first)

dd or dddd = 8 or 16 bit data (high byte first if 16 bit)

The data is formatted for easy(?) modification with a text editor. Well, easy if you know how the data in RAM is setup and understand hex.

Macro data: Each line of the Macro data contains one macro. There are 10 two byte macro commands on each line. Macro 0 is at memory location C800. Addresses are in DCC format (Refer to RP-9.2.1).

System data: Each line of the system data has 16 bytes of individual system setup 'flags'.

Consist data: Each line of the Consist data holds 8 locomotive addresses. Locations F500-F5FF hold lead loco addresses. The first two bytes are consist address 0 (not used) addresses are in DCC format (bits 6,7 of high byte set if long address). Locations F600-F6FF hold rear loco addresses. The first two bytes are consist address 0 (not used) addresses are in DCC format (bits 6,7 of high byte set if long address) . Locations F700-FBFF hold mid consist loco addresses. The first 8 bytes are up to 4 locos in consist address 0 (not used) addresses are in DCC format (bits 6,7 of high byte set if long address).

HIGHEST CAB TO PROGRAM ON MAIN

This sets the highest Cab address that will be able to access programming on the Main. Cabs above this setting will skip the PROGRAM ON MAIN menu selection. 00 = all Cabs have access. This and the following command station setup parameters are useful for clubs that have a lot of members but want to limit which of those members can access various system options during an operating session. Press **ENTER** to skip setting this parameter.

HIGHEST CAB TO ASSIGN LOCO

This sets the highest Cab address that will be able to access the Assign Loco to Cab menu. Cabs above this setting will skip the ASSIGN LOCO → CAB menu selection. 00 = all Cabs have access. Press **ENTER** to skip setting this parameter.

HIGHEST CAB TO SET CLOCK

This sets the highest Cab address that will be able to access the Set Clock menu. Cabs above this setting will skip the SET SYSTEM CLOCK menu selection. 00 = all Cabs have access. Press **ENTER** to skip setting this parameter.

HIGHEST CAB TO USE PROGRAM TRACK

This sets the highest Cab address that will be able to access the programming Track. Cabs above this setting will skip the USE PROGRAM TRK menu selection. 00 = all Cabs. Press **ENTER** to skip setting this parameter.

HIGHEST CAB TO SET COMMAND STATION

This sets the highest Cab address that will be able to Set Up the Command Station. Cabs above this setting will skip the SET CMD STATION menu selection. 00 = all Cabs. Press **ENTER** to skip setting this parameter.

HIGHEST CAB TO SET ITSELF

This sets the highest Cab address that will be able to access the Set Cab Parameters menu. Cabs above this setting will skip the SET CAB PARAMS menu selection. 00 = all Cabs have access. Press **ENTER** to skip setting this parameter.

HIGHEST CAB TO PROGRAM ACCESSORIES

This sets the highest Cab address that will be able to program Accessories while they are attached to the main track. Cabs above this setting will skip the PROG ACCESSORIES menu selection. 00 = all Cabs. Press **ENTER** to skip setting this parameter.

HIGHEST CAB TO PROGRAM MACROS

This sets the highest Cab address that will be able to program macros. Cabs above this setting will skip the PROGRAM MACROS menu selection. 00 = all Cabs. Press **ENTER** to skip setting this parameter.

HIGHEST CAB TO PROGRAM SIGNALS

This sets the highest Cab address that will be able to program signal decoders while they are attached to the main track. Cabs above this setting will skip the PROG SIGNALS menu selection. 00 = all Cabs. Press **ENTER** to skip setting this parameter.

HIGHEST CAB TO PROGRAM CONSISTS

You can set the highest cab number to set up, kill, or modify consists. A value of 0 allows all cabs access.

CLEAR ALL ADVANCED CONSISTS

This will kill ALL advanced consists contained in the system. It will clear lead, rear and mid consist locomotive addresses. A broadcast command is sent to ALL locomotives on the track to set CV 19 to 0

The cab will still show CON: until a new locomotive is selected.
. Press **1** to clear the consists.

CLEAR ALL CAB MEMORY

This will clear memory in a system. It will clear out all currently selected locomotives, all recalls, function status, speed and direction information for every cab. Cab address 2 will have locomotive 3 selected automatically, all other cabs will have short address 0 selected. Consists, Macros and Computer cab information will be preserved.

SET UP THE CAB PARAMETERS (Shortcut = PROG 6)

This allows the operator to set the Cab Address, the control method (yard or regular), ballistic tracking of the cab and which functions are activated when the Horn/Whistle and Bell keys are pressed.

NUMBER OF RECALLS

This adjusts the number of recall "slots" that are cycled through when the **RECALL** key is pressed. Enter a number of Recalls from 1 - 6 and press **ENTER**. This can be set differently for each Cab. (factory default is 2) Press **ENTER** to skip setting this parameter.

```
NUMBER 02:00PM  
OF RECALLS: 02
```

CLEAR RECALLS

Clears the current **RECALL** storage. Press 1 to clear out the **RECALL** slots, press **ENTER** to leave them alone. Press **ENTER** to skip setting this parameter.

```
CLEAR 02:00PM  
RECALLS 1=YES:
```

ANALOG HORN CHANNEL (default is 0)

```
ANALOG 02:00PM  
HORN CHANNEL -
```

If you have a decoder that supports a "playable" whistle such as a SoundTraxx Tsunami, enter the analog "channel number" that the decoder uses for whistle. You can play the whistle by holding the HORN/WHISTLE button while moving the thumbwheel. If the channel is set to 0 no analog commands will be sent.

ANALOG AUX CHANNEL (default is 0)

```
ANALOG 02:00PM  
AUX CHANNEL: -
```

ANALOG BIAS (default is 0)

```
ANALOG 02:00PM  
BIAS (0-15) -
```

This is the starting point or "level" (0-15) at which analog commands will start.

ASSIGNING HORN TO FUNCTION

```
ASSIGN 02:00PM  
HORN TO FUNC: 2
```

Enter the function number that should be activated when the Horn key is pressed. The NMRA suggests using 2, however any function number may be used. Press **ENTER** to skip setting this parameter.

ASSIGNING BELL TO FUNCTION

Enter the function number that should be activated when the Bell key is pressed. We recommend using 1, however any function number may be used.

```
ASSIGN 02:00PM  
BELL TO FUNC: 1
```

Older Soundtraxx **Steam** decoders use Function #3 for the Bell. The steam decoders can have the bell "re-mapped" to Function #1 (Diesel decoders can not re-map the bell to Function #3). Press **ENTER** to skip setting this parameter.

PROGRAM ACCESSORY DECODERS (Shortcut = PROG 7)

This allows the operator to set Accessory Decoder CVs while they are connected to the Track (Accessory Programming on the Main).

ENTER THE ACCESSORY ADDRESS

Enter the Accessory Decoder address and press **ENTER**.

```
PROG ACC 02:00PM
ACC. ADDR: _
```

ENTER THE CV NUMBER

Enter the CV number that you want to program and press **ENTER**.

```
PROG ACC 02:00PM
ENTER CV NUM: _
```

ENTER THE CV VALUE

Enter the value you want in the CV and press **ENTER**.

```
PROG ACC 02:00PM
ENTER VALUE: _
```

Accessory OPs programming now issues both the old "legacy" (5 byte) OPs command for accessories plus the "new" accessory OPs command (6 byte).

The old command could only address accessory decoders in groups of four. The new command can address one single decoder address. For the new command to work your accessory decoder must support the new packet.

PROGRAM MACROS (Shortcut = PROG 8)

This allows the operator to program Macros (switch lists).

SELECT MACRO PROGRAM OR REVIEW

Press 1 to program a Macro or press 2 to review a programmed Macro. If 1 is pressed the following screen is displayed.

```
MACRO: 02:00PM  
1=PROG 2=REVIEW
```

ENTER THE MACRO NUMBER

Enter the Macro number that you want to program (0-255), and press **ENTER**.

```
MACRO: 02:00PM  
MACRO NUMBER: _
```

ENTER THE ACCESSORY ADDRESS/LINKING MACROS

Enter the Accessory Address that you want to control, and press **ENTER**. A macro can be linked to another macro by entering an accessory address of 9999 at this point. You will be prompted for the macro number to link.

```
MAC: 000 02:00PM  
ACCESSORY #: _
```

You can chain as many macros together as you like but use caution. If you chain macros in a 'circular' fashion the system will appear to crash (it is busy sending macros continuously) until you press PROG/ESC on the cab that issued the macro. If a computer is used the only solution is to cycle the power to the system and fix the circular reference.

SELECT THE TURNOUT POSITION

Press 1 for Normal or 2 for Route.

```
MAC: 000 02:00PM  
ACC: 001 1=N 2=R
```

The above two screens will repeat up to 10 times to allow you to enter up to 10 accessories. After 10 accessories have been entered the SELECT MACRO PROGRAM OR REVIEW screen will be displayed. If you want to enter less than 10 accessories, leave the accessory # blank (just press **ENTER**).

If 2 is pressed on the SELECT MACRO PROGRAM OR REVIEW screen, the following screen is displayed.

ENTER THE MACRO NUMBER TO BE REVIEWED

Enter the Macro number that you want to review (0-255), and press **ENTER**.

```
REVIEW: 02:00PM  
MACRO NUMBER: _
```

REVIEW MACRO

The Accessory number and output will be shown. Press **ENTER** to see the next Accessory in the Macro. If there are no more Accessories in the Macro, the following screen will be displayed.

```
MAC: 000 02:00PM  
ACCESSORY: 001=N
```

REVIEW END OF MACRO

After **ENTER** is pressed, the SELECT MACRO PROGRAM OR REVIEW screen will be displayed.

```
MACRO: 02:00PM  
END OF MACRO
```

BROWSE CONSISTS (Shortcut = PROG 9)

This option lets you see what advanced consists are currently in the memory of the system.

Press **ENTER** at the "BROWSE CONSISTS" prompt. The LCD will display the highest numbered consist in the system memory. It will look something like:

```
CON: 127 10:42AM  
LEAD:2190 R:4484
```

Use the speed buttons or thumbwheel to scroll the next higher or lower consist in the list. When you get to the end of the list it will roll over to the 'other' end. Pressing **ENTER** will show any mid consist locomotives of the displayed consist.

Pressing **ENTER** while the Lead/Rear locomotives are displayed will show any mid-consist locomotives. (The system will remember up to 4 mid-consist locos per advanced consist). Press **ENTER** again to view the next consist.

Pressing **SEL LOCO** will exit browsing and select the displayed consist for running.

Pressing **CLEAR** then pressing 1 at the "KILL CON?" prompt will kill the displayed consist.

Press **PROG/ESC** at any time to exit browsing.

PROGRAM SIGNAL DECODERS (Shortcut = PROG 0)

This allows the operator to setup Signal Decoders while they are connected to the Track (Signal Programming on the Main). Address 2044 is the broadcast address for signal decoders.

ENTER THE SIGNAL ADDRESS

Enter the Decoder address and press ENTER.

```
PROG ACC 02:00PM  
SIGNAL NUM: -
```

ENTER THE CV NUMBER

Enter the CV number that you want to program and press ENTER.

```
PROG ACC 02:00PM  
ENTER CV NUM: -
```

ENTER THE CV VALUE

Enter the value you want in the CV and press ENTER.

```
PROG ACC 02:00PM  
ENTER VALUE: -
```

PLAYABLE WHISTLE OR HORN

If you have advanced sound decoders such as SoundTraxx™ Tsunami™ or Digitrax Sound FX™ you can set up your NCE Pro Cab or Cab 04e to access the playable whistle/horn feature of the decoder. You will play the whistle/horn by holding down the **HORN/WHISTLE** button while operating the thumbwheel or knob. When you release the **HORN/WHISTLE** button you will be returned to speed control. The ballistic tracking of the thumbwheel applies to the whistle/horn as well as speed control. If you move the thumbwheel fast the whistle/horn will reach maximum pitch faster. You may want to adjust the ballistic tracking in the cab for a better feel.

In factory default configuration the **HORN/WHISTLE** button sends only momentary function on/off commands. To enable sending of playable whistle/horn commands you must set the ANALOG HORN CHANNEL (in the SET CAB PARAMS menu) to match the analog horn channel of the decoder. Values from 0-255 are valid. If 0 is chosen no analog commands will be sent. The playable whistle/horn channel is normally 127.

Once the analog horn channel is set to the proper channel you should set the ANALOG BIAS. This is the starting pitch value for playing the whistle or horn. Values can be from 0-15, we normally use 8. If you leave the bias set to 0 the whistle will always start at its lowest pitch.

You can have different analog channels on each cab. Every cab can also have its own bias point as well to match each operator's personal taste.

If configured for playable whistle/horn the **HORN/WHISTLE** button simultaneously sends analog commands along with normal function on/off commands. This allows you to sound the whistle/horn on non-playable whistle/horn decoders or play the whistle/horn on advanced decoders without having to change the whistle/horn settings of the cab when running different locomotives.

Enabling the playable whistle/horn on sound decoders:

SoundTraxx™ Tsunami™ - Set CV 47 = 127

Digitrax™ Sound FX™ - Set CV 150 = 1

ESU™ V3.5+ - See the ESU decoder manual

Alternate Playable Whistle or Horn using the OPTION button

The **OPTION** button can also be used to control playable whistles/horns when programmed for AUX analog operation.

The analog channel for the **OPTION** button can be chosen under the SET CMD STATION menu. Values from 0-255 are valid. If 0 is chosen, no analog commands will be sent. You can play the whistle/horn in the same manner as when the HORN/whistle button is set for playable whistle/horn. Hold the **OPTION** button down while operating the thumbwheel. When you release the button you will be returned to speed control.

You must program the **OPTION** button of the Pro Cab to 123 for this feature to work.

Programming the **OPTION** button:

- Unplug the Pro Cab
- Hold down the **SELECT LOCO** button while plugging in
- Press **ENTER** (about 5 times) until you are prompted for the **OPTION** button value
- PUT in 123 and press **ENTER**
- Press **PROG/ESC** to get back to operations mode

RS232 SERIAL COMPUTER INTERFACE

CABLE

You can use a Male 9 pin D connected to a Female 9 pin D with ribbon cable, or use a 9 pin D extension cable.

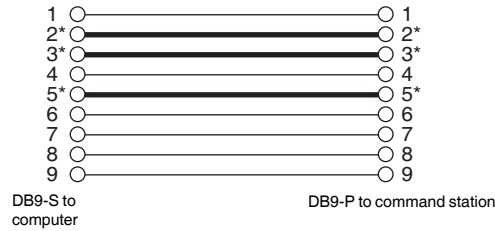

Note: The signals marked with an "*" are the only ones that are necessary.

USB TO SERIAL ADAPTER CABLE

It is possible to use a USB to Serial Adapter cable with your system. Most adapters are known to work.

COMMUNICATIONS PARAMETERS

The factory default baud rate is 9600 baud. You can use the SET CMD STA menu to change the baud rate to 19200 or 38400. The rest of the communications parameters are 8 bits, No parity, and One stop bit. If you are using a terminal program on a PC, set it to echo characters. The characters sent to the Command Station are not echoed.

ASCII COMMAND SET

The ASCII command set is no longer supported except for programming track related commands. These commands are no longer listed as they will be deleted in the next revision of the system software. Use the binary command set.

BINARY COMMAND SET

The RS-232 port binary commands are designed to work in a computer friendly way.

Command format is: <command number> <data> <data> ...

Commands range from 0x80 to 0xBF

Commands and formats supported:

Commands 0xAD to 0xBF are not used and return '0'

Errors returned:

'0'= command not supported

'1'= loco address out of range

'2'= cab address out of range

'3'= data out of range

'4'= byte count out of range

'!'= command completed successfully

For a complete description of Binary Commands see: www.ncecorporation.com/pdf/bincmds.pdf

CMD FORMAT	DESCRIPTION	# OF BYTES RETURNED	POSSIBLE RESPONSES
0x80	NOP, dummy instruction	(1)	!
0x81 xx xx yy	assign loco xxxx to cab cc	(1)	!, 1, 2
0x82	read clock	(2)	<hours><minutes>
0x83	Clock stop	(1)	!
0x84	Clock start	(1)	!
0x85 xx xx	Set clock hr./min	(1)	!, 3
0x86 xx	Set clock 12/24	(1)	!, 3
0x87 xx	Set clock ratio	(1)	!, 3
0x88 xxxx	Dequeue packet by loco addr	(1)	!, 1, 2
0x89	Enable main trk, kill prog	(1)	!
0x8A yy	Return status of AIU yy	(4)	<current hi byte> <current lo byte> <change hi byte> <change lo byte>
0x8B	Kill main trk, enable prog	(1)	!
0x8C	dummy inst. returns"! " followed CR/LF	(3)	!0x0D, 0x0A
0x8D xxxx mm	Set speed mode of loco xxxx to mode mm, 1=14, 2=28, 3=128	(1)	!, 1, 3 <speed mode, 0 to 3>
0x8E aaaa nn <16 data bytes>	Write nn bytes, start at aaaa Must have 16 data bytes, pad them out to 16 if necessary	(1)	!, 4

CMD FORMAT	DESCRIPTION	# OF BYTES RETURNED	POSSIBLE RESPONSES
0x8F aaaa	Read 16 bytes, start at aaaa	(16)	16 bytes
0x90 cc xx...	Send 16 char message to Cab ccLCD line 3. xx = 16 ASCII char	(1)	!, 2
0x91 cc xx	Send 16 char message to cab cc LCD line 4. xx=16 ASCII	(1)	!, 2
0x92 cc xx	Send 8 char message to cab cc LCD line 2 right xx=8 char	(1)	!, 2
0x93 ss <3 byte packet>	Queue 3 byte packet to temp_Q send ss times	(1)	!
0x94 ss <4 byte packet>	Queue 4 byte packet to temp_Q send ss times	(1)	!
0x95 ss <5 byte packet>	Queue 5 byte packet to temp_Q send ss times	(1)	!
0x96 ss <6 byte packet>	Queue 6 byte packet to temp_Q send ss times	(1)	!
0x97 aaaa xx	Write 1 byte to aaaa	(1)	!
0x98 aaaa xx xx	Write 2 bytes to aaaa	(1)	!
0x99 aaaa<4 data bytes>	Write 4 bytes to aaaa	(1)	!
0x9A aaaa<8 data bytes>	Write 8 bytes to aaaa	(1)	!
0x9B yy	Return status of AIU yy (short form of command 0x8A)	(2)	<current hi byte> <current lo byte>
0x9C xx	Execute macro number xx	(1)	!, 0, 3
0x9D aaaa	Read 1 byte from aaaa	(1)	1 byte
0x9E	Enter programming track mode	(1)	!=success 3=short circuit
0x9F	Exit programming track mode	(1)	!=success
0xA0 aaaa xx	Program CV aa with data xx in paged mode	(1)	!=success 0=program track no
0xA1 aaaa	Read CV aaaa in paged mode Note: cv data followed by ! for OK. 0xFF followed by 3 for can't read CV	(2)	!, 0, 3
0xA2<4 data bytes>	Locomotive control command See Page 77	(1)	!, 1

CMD FORMAT	DESCRIPTION	# OF BYTES RETURNED	POSSIBLE RESPONSES
0xA3 <3 byte packet>	Queue 3 byte packet to TRK_Q (replaces any packet with same address if it exists)	(1)	!, 1
0xA4 <4 byte packet> 0xA4 xx xx...	Queue 4 byte packet to TRK_Q (replaces any packet with same address if it exists)	(1)	!, 1
0xA5 <5 byte packet> 0xA5 xx xx...	Queue 5 byte packet to TRK_Q (replaces any packet with same address if it exists)	(1)	!, 1
0xA6 rr dd	Program register rr with dd	(1)	!=success 0=program track no
0xA7 rr	Read register rr. Note: cv data followed by ! for OK. 0xFF followed by 3 for can't read CV	(2)	!, 3 0=program track no
0xA8 aaaa dd	Program CV aaaa with dd in direct mode.	(1)	!=success 0=program track no
0xA9 aaaa	Read CV aaaa in direct mode. Note: cv data followed by ! for OK. 0xFF followed by 3 for can't read CV	(2)	!, 3 0=program track no
0xAA	Return software revision number. Format: VV.MM.mmm	(3)	3 data bytes
0xAB	Perform soft reset of command station (like cycling power)	(0)	Returns nothing
0xAC	Perform hard reset of command station. Reset to factory defaults (Note: will change baud rate to 9600)	(0)	Returns nothing
0xAD <4 data bytes>	Accy/signal and macro commands See Page 77	(1)	!, 1
<p>NOTE: A single byte of 0 will be returned if not in programming mode for commands 0x9F, 0xA0, 0xA1 and 0xA6 through 0xA9.</p> <p>Errors returned: '0'=Command not supported '1'=Loco/Accy/Signal address out of range '2'=Cab address or OP code out of range '3'=Data out of range '4'=Byte count out of range '!'=Command completed successfully</p> <p>Enter: BIN_BUFF contains completed binary command.</p> <p>Exit: Action performed based on command RS232FLAGS bits 0 and 1 cleared to 0 BINSVPTR set to BIN_BUFF BIN_RXCOUNT and BIN_RXEXPECTED cleared to 0</p>			

0xA2 sends speed or function packets to a locomotive.

Command Format: 0xA2 <addr_h> <addr_l> <op_1> <data_1>

Addr_h and Addr_l are the loco address in DCC format.
If a long address is in use, bits 6 and 7 of the high byte are set.

Example: Long address 3 = 0xc0 0x03
Short address 3 = 0x00 0x03

op_1	data_1	Operation description
01	0-7f	Reverse 28 speed command
02	0-7f	Forward 28 speed command
03	0-7f	Reverse 128 speed command
04	0-7f	Forward 128 speed command
05	0	Estop reverse command
06	0	Estop forward command
07	0-1f	Function group 1 (same format as DCC packet for FG1)
08	0-0f	Function group 2 (same format as DCC packet for FG2)
09	0-0f	Function group 3 (same format as DCC packet for FG3)
0a	0-7f	Set reverse consist address for lead loco
0b	0-7f	Set forward consist address for lead loco
0c	0-7f	Set reverse consist address for rear loco
0d	0-7f	Set forward consist address for rear loco
0e	0-7f	Set reverse consist address for additional loco
0f	0-7f	Set forward consist address for additional loco
10	0	Del loco from consist
11	0	Kill consist
12	0-9	Set momentum
13	0-7f	No action, always returns success
14	0-7f	No action, always returns success
15	0-ff	Functions 13-20 control (bit 0=F13, bit 7=F20)
16	0-ff	Functions 21-28 control (bit 0=F21, bit 7=F28)
17	0-3f	Assign this loco to cab number in data_1
18-7f		reserved reserved

Returns: ! = success
1 = bad loco address

0xAD sends accessory or signal packets

Command Format: 0xAD <addr_h> <addr_l> <op_1> <data_1>

The address range is 1-2047
Addr_h and Addr_l are the accessory/signal address (NOT in DCC format).

Example: Accessory Address 513 = 0x02 0x01 (hi byte first)
Accessory Address 6 = 0x00 0x06 (hi byte first)

NOTE: accy/signal address 0 is not a valid address
address 2044 is the broadcast address

Op_1	Data_1	Operation description
01	0-255	NCE macro number 0-255
02	0-255	Duplicate of Op_1 command
03	0	Accessory Normal direction (ON)
04	0	Accessory Reverse direction (OFF)
05	0-1f	Signal Aspect 0-31
05-7f	reserved	reserved

Returns: ! = success
1 = bad accy address

HELPFUL HINTS FOR OPERATION

- Passing an old style consist: Use **ASSIGN LOCO TO CAB** to transfer an old style consist to any other Cab on the system. This causes a *swap* between the active loco/consist on your Cab and the active loco/consist on the target Cab.
- Nesting consists: Say a heavy freight is approaching a long grade and helpers are needed. The train's locomotives are an advanced consist. The two GP9 pushers are also consisted using an advanced consist. The pusher consist is brought out of the siding at the base of the grade and put in place. A "old style" consist is now set up using the freight's lead loco number and the pusher's lead loco number. You can now operate the entire train to the grade crest as one unit. Upon reaching the cutoff siding at the crest the "old style" consist is killed and the pushers are selected to move to the siding. The freight consist continues on while the pushers drift back down the hill.
- When setting up an old style Consist, you may want to use a Loco number that does not exist for the first Loco (Consist address). This will allow you to put the actual lead loco in recall to operate the headlight, and the sound loco to operate the Horn and Bell.
- If a cab does not respond after plugging it in, press the **ENTER** key a couple of times. This will cause it to exit from any mode it was in when it was unplugged.
- When making your own cables using RJ plugs be SURE the connectors are "flipped" over at opposite ends of the wire. See the illustration on page 25 for proper cab bus cabling.

Power booster

- Your power booster can put out considerable power. Sufficient input power is required for it to perform to its optimum. Proper AC wiring and fusing of the transformer is required to prevent melted wiring or possibly a fire.
- Your power booster is internally protected by an automatic shutdown circuit. After shutdown in the presence of a short circuit it will automatically restore power after 2 seconds.
- The 5 Amp power booster is factory set to put out 14.25 volts to the track. This voltage is adjustable from 10 to 18 volts, see the Power Booster portion of this manual for instructions on adjusting the voltage. The voltage delivered to the motor or lights of a locomotive will typically be about 1 volts less than the voltage on the track.

Using the ProCab

- In DCC there are 2 kinds of addresses (loco numbers), long and short. When entering the address of the loco you wish to control long addresses from 1 to 127 are entered by preceding the actual number by a zero. Short addresses are entered without a leading zero. Long addresses in the range of 1 -127 are displayed on your cab with an asterisk before the loco number. ie: "*"042" indicates the long address for loco forty-two and "042" indicates the short address. Most modern decoders made since 1997 support long (4 digit) addresses. Older Lenz, Digitrax and MRC decoders only support the short address.
- When entering numbers if you make a mistake there is no "erase" or "backup" key. If you keep pressing digits the display will clear allowing you to start entering your number over again.
- If you wish to abandon what you are doing when in the middle of entering a number push the "PROG/ESC" key and you will be returned to normal operation.
- During various operations where you are doing something other than normal loco operation such as "set up consist" or "select accessory" speed control of the loco is not available, however the Emergency Stop will still work if you need to stop your loco.
- programming on the programming track the command station first reads the value of a location (such as "short address" or "acceleration") and displays it on your cab. If you wish to accept this value just press ENTER to continue or type in a new number if you want to change it.

Programming Track

- The command station checks for a short circuit on the programming track before applying power. If your loco has lights or other current drawing devices wired directly to the track instead of a decoder function output the command station will probably think it has a short and will say "SHORT DETECTED" each time you start to program this loco. If you wish you will be allowed to override the short and continue. This short detection is there to protect decoders from damage if they are miswired. For this reason we always try a new decoder installation on the programming track first instead of putting it directly on the layout. If the programming works the installation is most likely correct.
- If you have tried to use "STD" programming the MRC decoder will not respond until you program it using REGister mode.
- Older MRC decoders can be easily programmed using "REG" programming (option 3 at the "PROG TRK" menu).

TROUBLE SHOOTING

- Locomotive was running yesterday but today it just sits there - The headlight and other functions are controllable but it won't run. This sometimes happens when you clear a consist but for some reason the decoder misses the command. Use the **DEL LOCO** button to "re-delete" the locomotive. Alternatively use programming on the main to set CV19 to 0 (same thing as clearing the consist).
- Head Light goes on and off as I change speed - You are operating a loco with an older 14 step decoder in the 28 step mode and the head light is ON only in the even speed steps.
- The programmability of the decoders gives the modeler a *lot* of flexibility. However, this can lead to some unpredictable results. Here are a few tips to get you out of some situations:
 - Loco won't respond - Check that the short/long address bit is set correctly in the CFG variable (CV 29).
 - The loco might be in a consist - Press **DEL LOCO**, the locomotive number then **ENTER**.
 - Make sure CV3, 4, 23, 24 are set to a small enough value to allow the loco to accelerate at a reasonable rate
 - Loco won't run on an analog (DC) layout - Check that the DC mode bit is set in the CFG variable (CV 29).



Copyright & Trademarks

Copyright © 1994-2007 NCE Corporation. The identifying product terms Power Pro, PH-Pro, ProCab, and SmartCab are trademarks of NCE Corporation. The look and feel of this software and its interaction with the user through the ProCab or SmartCab is copyright NCE Corporation. The distinctive shape of the ProCab with LCD and/or thumbwheel is a trademark of NCE Corporation. Digitrax® is a registered trademark of Digitrax® Inc. All other non-NCE brands and product names mentioned are likely to be trademarks or registered trademarks of their respected companies.

Limited Warranty

NCE guarantees that every Power Pro DCC System is free from physical defects in material and workmanship for a period of 1 year.

Within the first year full repair or replacement will be made to the original purchaser of any item that has failed due to manufacturer defect. Should the item no longer be produced and the item not repairable a similar item will be substituted at the manufacturer's discretion. The customer pays only shipping to the NCE Warranty Center. Please save your original receipt as a photocopy of it may be requested. NCE returns the items UPS ground unless other arrangements are made in advance.

After the first year a fair and reasonable service charge may be placed on each failed item returned for repair. Should the item no longer be produced and the item not repairable a similar item will be substituted at the manufacturer's discretion. The customer pays shipping to and from the NCE Warranty Center.

This warranty is not valid if the customer has intentionally misused, miswired, performed any unauthorized alterations to the product or removed any product protection devices (such as heat shrink wrapping from decoders). In this case a service charge will be applied for all repairs and replacements. To protect the warranty, please contact the Warranty Center for authorization prior to altering any product. In no event will NCE's liability exceed the price paid for the product from direct, indirect, special, incidental or consequential damages resulting from the use of the product, it's accompanying software or its documentation. NCE makes no warranty or representation, expressed, implied or statutory with respect to its products or the contents or use of this documentation and accompanying software and specifically disclaims its quality, performance, merchantability, or fitness for any particular purpose. NCE reserves the right to revise or update its products, software, or documentation without obligation to notify any individual or entity.

Please contact the Warranty Center for specific shipping instructions and any service charges before returning any product for service. Address all inquiries to:

NCE Warranty Center
899 Ridge Road
Webster, New York 14580
Phone: 585-671-0370 Fax: 585-671-9337

Please check our web site: www.ncedcc.com to ensure that you have our latest address.

FCC Statement

This NCE product has been tested to comply with the limits for a Class B digital device, pursuant to Part 15 of the FCC rules. These limits are designed to provide reasonable protection against harmful interference in a residential installation. This equipment generates, uses and can radiate radio frequency energy and, if not installed and used according to the instructions, may cause harmful interference to radio communications. However, there is no guarantee that interference will not occur in a particular installation. Keep in mind that by FCC rules, **all** electronic equipment must accept any interference, including interference that may cause undesired operation. If this equipment does cause harmful interference to radio, or television reception, which is found by turning the equipment off and on, the user is encouraged to correct the interference by one or more of the following measures:

- Reorient or relocate the receiving antenna
- Increase the separation between the equipment and the device
- Connect the equipment to an outlet other than the receiver's
- Consult a dealer or an experienced radio/TV technician for assistance

About NCE

NCE has been manufacturing DCC Products on an OEM basis since 1993. Originally we offered only "chip sets" that contained software enabling other DCC manufacturers to build DCC systems. As time went on some of those manufacturers asked us to first supply partial assemblies then complete assemblies in addition to the chip sets. This has helped NCE to grow into a full time electronic design and manufacturing firm devoted entirely to the development and sale of products for the control of model railroads. We build an amazing array of products for both our own customers and other DCC manufacturers. We keep labor costs low by utilizing modern automated robotic assembly for most products.

Our product designer is Jim Scorse. Jim models the Erie Railroad in O-Scale and has a long history in model railroading. He has numerous patents in the area of digital imaging, video and computer network data communications over noisy channels. Jim is active in the Layout Design SIG as well as 32 years with the "Tuesday Night Gang", (round robin model railroad club) and is probably one of the only active model railroaders among all the DCC manufacturers.

NOTES

Loco	Decoder Make/Model	Mfr#	Ver#	Address	CV2	CV5	CV6	CV29	CV95

Loco	Decoder Make/Model	Mfr#	Ver#	Address	CV2	CV5	CV6	CV29	CV95

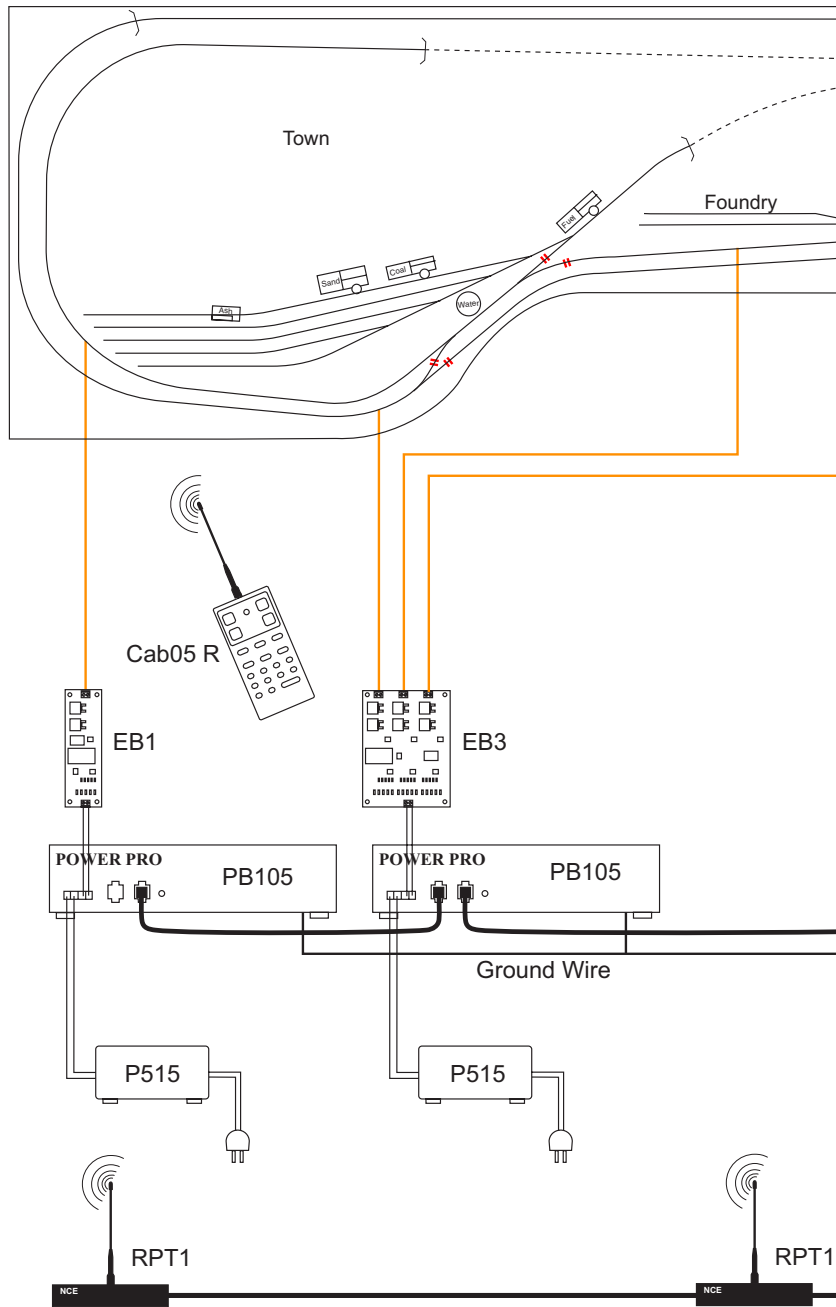

TIP: Rick Lake of St. Louis passes along this simple but quite innovative suggestion that his wife, Venita came up with. When wiring a railroad, use an old or not too special box car and paint one side red and the other side blue. You could also place a tag with a + sign on one side and a - sign on the other. This way, when dropping leads down to your track bus polarity is assured by using the indication on the box car. Why didn't WE think of that? Thanks Venita!!

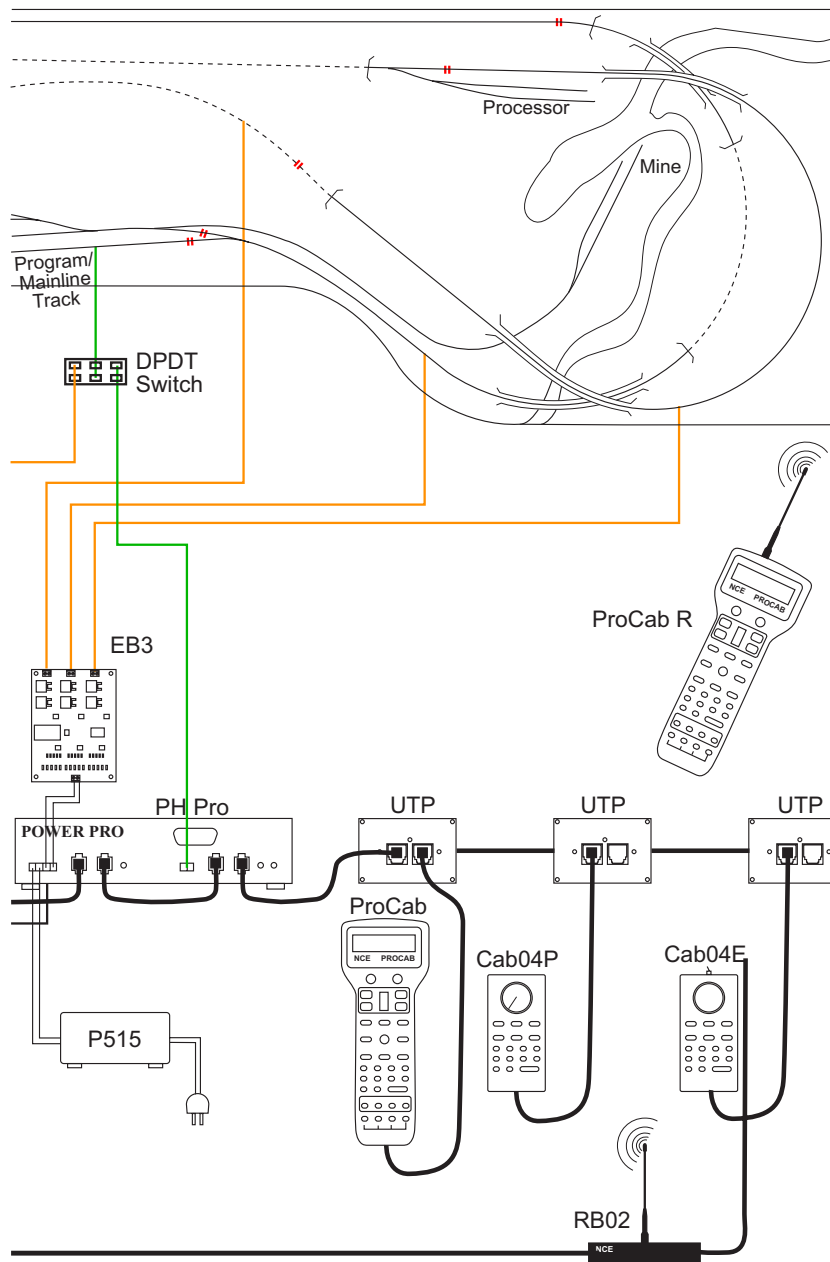

Advanced Layout Wiring

MENU NAVIGATION CHART - PT. 1

Press PROG/ESC key to cycle through menu listings, then press ENTER to cycle through listing choices.

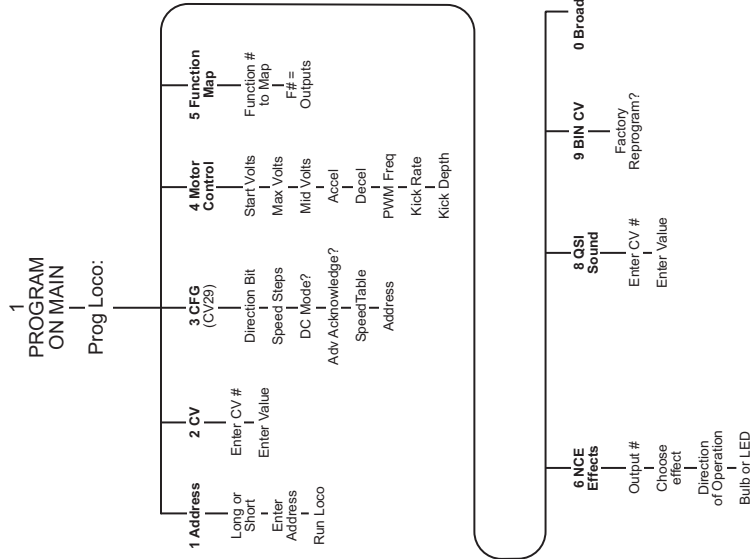

MENU NAVIGATION CHART - Part 2

Press PROG/ESC Key to cycle through menu listings, then press ENTER to cycle through listing choices

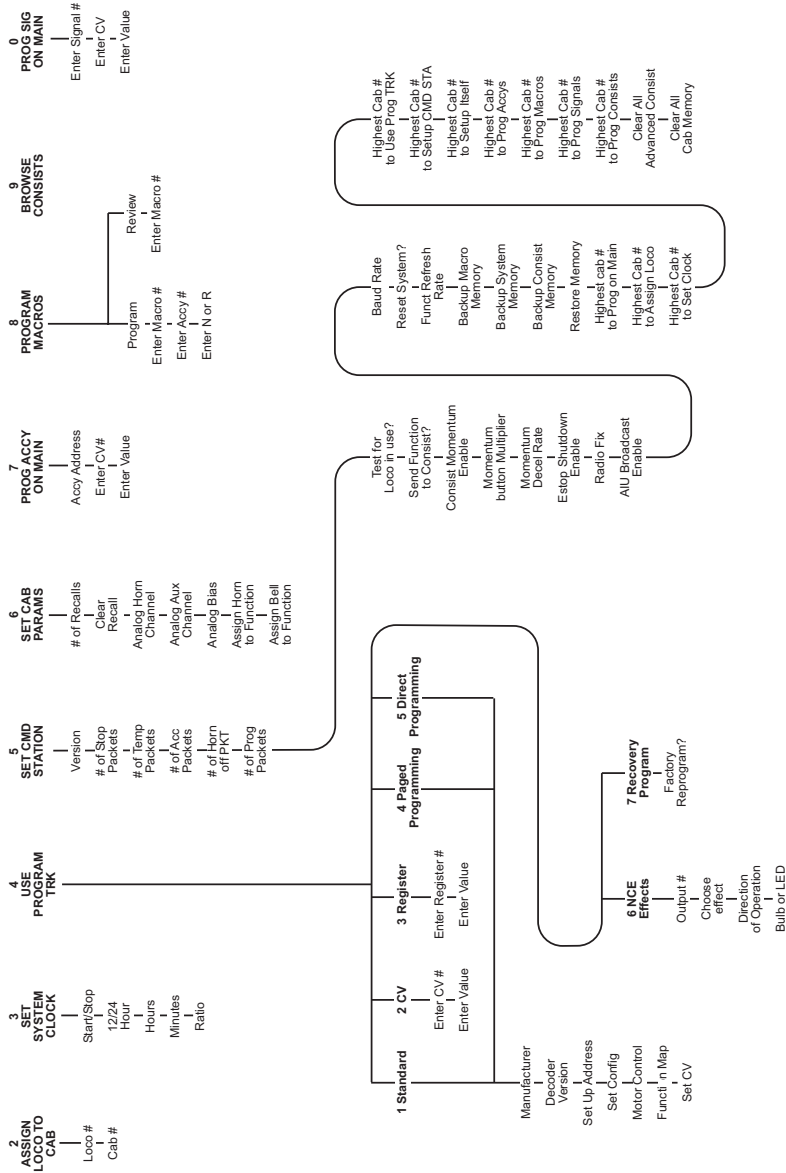



**NCE Corporation
899 Ridge Road
Webster, NY 14580
(585) 671-0370
ncedcc.com**



05240300