

Power Cab System Reference Manual

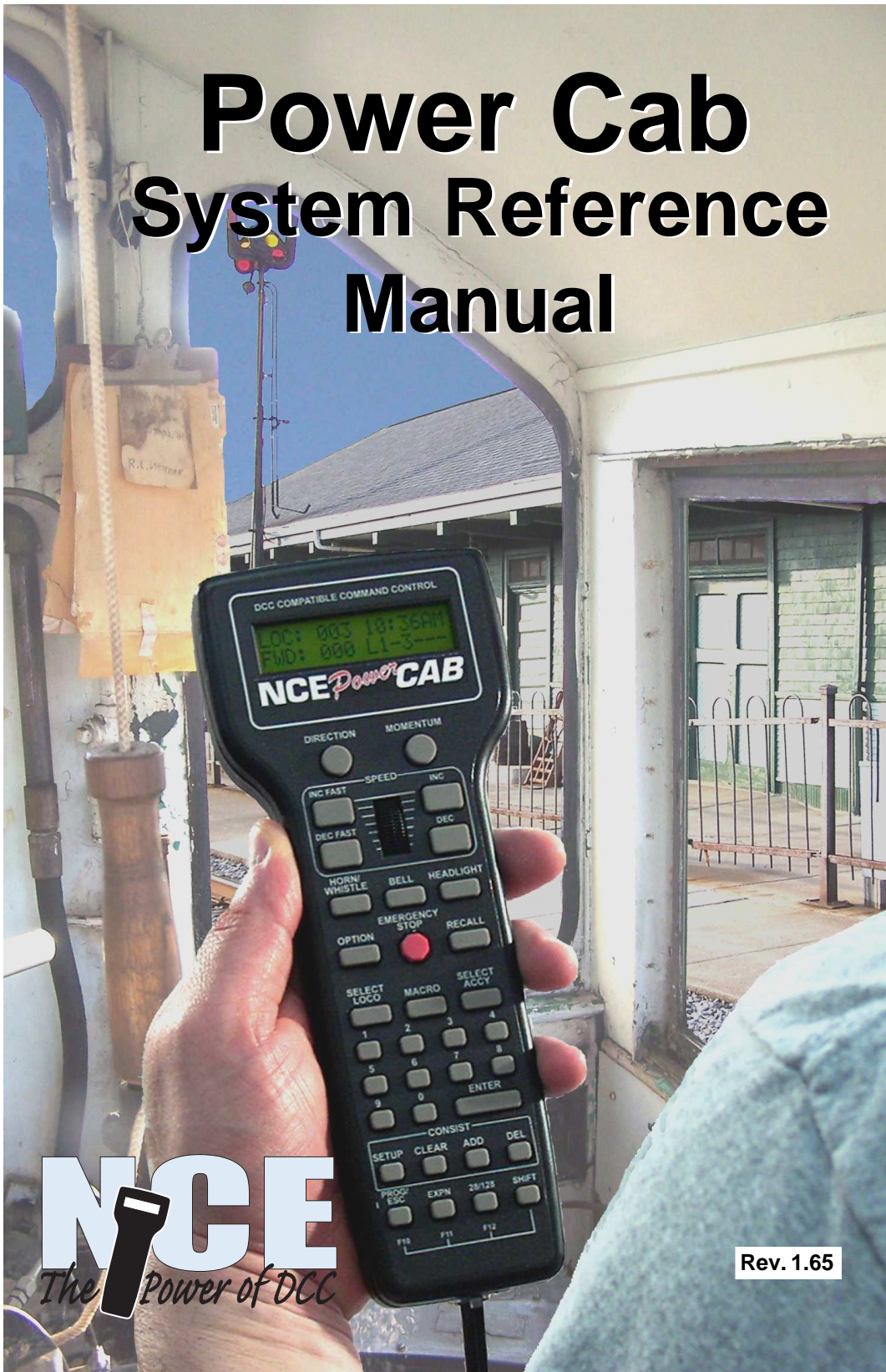

NCE
The Power of DCC

Rev. 1.65

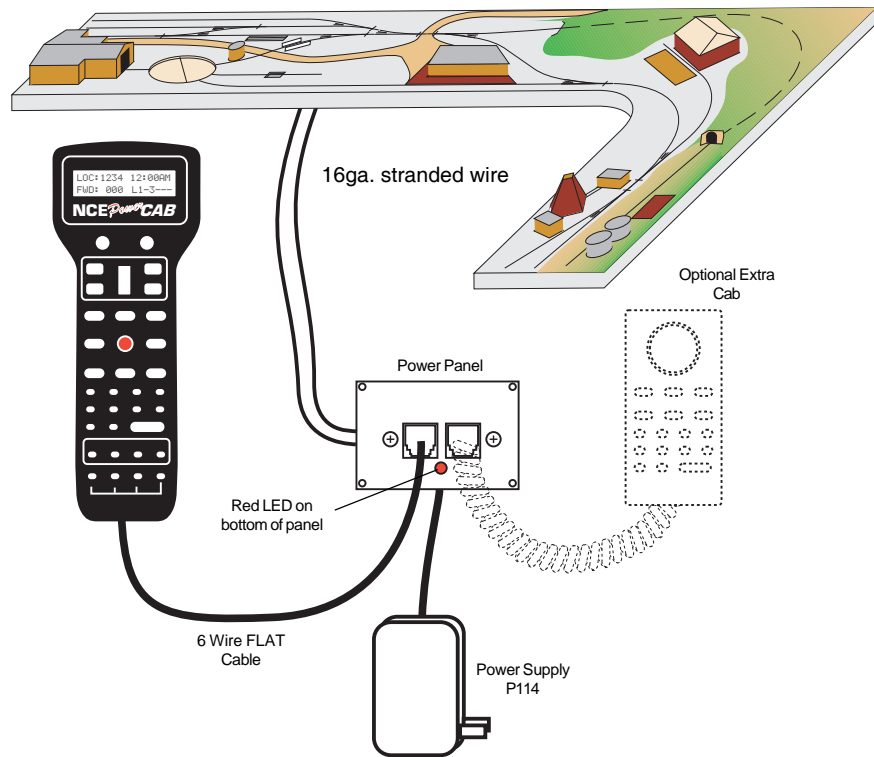

Basic Set Up of the Power Cab System

Your Power Cab™ is a full featured DCC system. It must be used with the 6 wire, **FLAT** cable supplied. All features described in this manual are available to you when used in the Power Cab™ mode. If you own or operate with a PowerHouse™ or Power Pro™ NCE system, you can use the Power Cab™ as a Pro Cab™ using the 4 wire coiled cord that is also supplied. An NCE P114 power supply (13.8VDC Regulated) is the supplied transformer for your system.

Quick Start

Contents of the Power Cab™ System:

Power Cab™	Power Panel (marked PCAB-PP)
Seven foot flat cable	Coil Cord (4 wire) to use as a Pro Cab
Power Supply	Power Cab™ system reference manual

We recommend that you follow the instructions below to connect your system to a small test track first. After your system is checked out completely and known to be working then consider the final installation locations for components and connections to the track.

TRYING OUT YOUR POWER CAB™:

- #1 Assemble the Power Panel by screwing the black plate to the circuit board with screws provided.
- #2 Connect the long 7 foot flat cable from the Power Cab™ into the socket marked (on the drawing) POWER CAB™ (with the LED below the jacks) use the left socket).
- #3 Use a small, flat screw driver to attach the test track feeder wires to the small two place connector. Make sure that there are no shorts or frayed wires between the connections.
- #4 If you have a locomotive with a DCC decoder already installed place it on the track.
- #5 Plug the power supply into the socket marked POWER. Plug the power supply into a wall outlet. If the red light of the panel lights up you are ready to go. If it blinks on and off your have a short, shut off power
- #6 The display of the cab should look something like

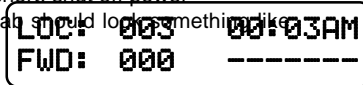

This is what we call the 'NORMAL DISPLAY'. The fast clock in the upper right hand corner will most likely show a different time.

The following cab buttons must be pressed in the proper sequence to acquire control of the locomotive #3 (in the above example locomotive #3 is already selected):

Note: By convention, locomotive decoders usually have their short address set to 3 at the factory.

- a. Press **SELECT LOCO** button once.
- b. Press the "3" button once. DO NOT press 0 then 3.
- c. Press **ENTER**.

TIP #1 If you make a mistake while entering numbers on the cab just keep pressing more numbers until the number entry field clears, then enter the correct numbers.

TIP #2 Whenever the cab is waiting for you to enter data (a flashing black square is on the screen at the point where the numbers will go) you can press the **PROG/ESC** key to "escape" what you were doing and return to normal operation mode.

TIP #3 Whenever you have pressed a button (such as **SELECT LOCO**) and you want to keep what ever number that is already on the screen just press **ENTER**.

- #7 To operate the locomotive, the following controls are used:
 - a. The thumbwheel will increase/decrease speed. The speed control buttons that flank the thumbwheel on either side may also be used as desired to control the loco speed.
 - b. Pressing the **DIRECTION** button will cause the loco direction to reverse.

CONGRATULATIONS! You are now operating a locomotive with DCC control. In most cases, less than ten minutes has elapsed since you started reading this Quick Start Guide.

COMPLETING THE QUICK START

Operating one locomotive is fun — for awhile. But operating two locomotives is a lot more fun for a much longer time. Advancing beyond this simple DCC testing requires decoder installation into more locomotives and perhaps a few straight pieces added to your circle of track. After you have two locomotives with decoders we can continue with both locomotives simultaneously operating under DCC control. At least one locomotive will need to be programmed with a different address.

PROGRAMMING A LOCOMOTIVE ADDRESS

- #1 The first item of business in this section is to remove any locomotives from the layout that will **not** be programmed.
- #2 Place the locomotive to be programmed with an installed decoder on the track.
- #3 Press the **PROG/ESC** button four times (bottom left corner) to get to the programming track menu.

Your cab should read:

```
SELMODE xx:xxPM
USE PROGRAM TRK
```

xx:xx represents the fast clock which may display any time at this point.

- #4 Press **ENTER** to use the programming track and you will see:

```
PROG TRK xx:xxPM
1=STD 2=CV 3=REG
```

- #5 Press "1" to use Standard programming. You will see:

```
MANUFACTURER: 

```
MAIN OFF xx:xxPM

```

```

After a moment the blank space after MANUFACTURER: will be filled in with the NMRA code for the maker of the decoder. All manufacturers have different codes.

If you get a CAN NOT READ CV message the decoder is not responding. Check the locomotive, decoder and programming track wiring. An older decoder that uses "paged" mode (discussed later) can take up to 15 seconds to read the values.

- #6 Press **ENTER** to read the decoder version installed in your locomotive.
- #7 Press **ENTER** again to see:

```
ACT RAIL CIRCLED BULB CIRCUIT SHORT
SETUP ADR 1=YES
```

By convention all DCC locomotive decoders are set to short address 3 or long address 3333 at the factory. If your decoder has not had its address changed you will see a short address as the active address. Press **1** to set up the address.

```
ACTIVE ADR: SHORT
SHORT ADR: 003
```

TIP A decoder can have 2 different addresses, the Short Address (values from 1-127) or the Long Address (sometimes called 4 digit with a range of 0000-9999). A decoder can use one or the other but not both at the same time. Some entry level decoders can only use the Short Address.

#8 Press **ENTER** to keep the current short address set to 3.

#9 Press **ENTER** to skip activating the short address.

#10 Next you will see the Long Address (which is probably set to 0000 or sometimes to 9999). With older decoders, it may take a up to 30 seconds to read the long address.

This is the address we will change.

#11 You will likely want to enter the number on the side of the locomotive cab as the Long Address. Type in the number of the locomotive and press **ENTER**.

#12 Press **1** to activate the Long Address.

You have just changed the Long Address.

At this point, press **PROG/ESC** twice to exit the program track mode.

You have just completed the hardest part of DCC... programming the locomotive on the programming track.

To select the locomotive:

- a. Press **SELECT LOCO** button
- b. Press the digits corresponding to the Long Address you just programmed..
- c. Press **ENTER**

At this point you should have control of the locomotive. Now is the time to program up a second locomotive and run them both.

RUNNING TWO LOCOMOTIVES WITH ONE CAB

#1 Select the first locomotive you wish to run (**SELECT LOCO** followed by its address then **ENTER**).

#2 Press **RECALL** to store this locomotive in one of the internal recall "slots" of the cab. The display of the cab will now show a locomotive of 000.

#3 Select the second locomotive and start running it.

#4 By pressing **RECALL** you can toggle back and forth between the two different locomotives. At any time you can select a new locomotive "over the top" of any locomotive already on the display. The existing locomotive will be forgotten by the cab with the new one taking it's place. The one in **RECALL** will remain available for recall.

CUSTOMER SERVICE

Customer Service is handled through our factory warranty center or by your dealer. It is faster to deal direct with the factory. Please write or call us before returning any products to our warranty center. Sometimes the problem is easily solved over the phone. If writing make sure you include your name, address and phone number and the times that you can be reached at that number. This will greatly expedite our service to you if you have questions.

NCE Warranty Center
82 East Main St.
Webster, NY 14580

Phone: (585) 265-0230

Fax: (585) 265-0234

Email Address: support@ncecorporation.com

Web Site: www.ncedcc.com

We reserve the right to either repair or replace components sent to us for in-warranty service. The warranty period will begin on the date shown on your retail sales receipt. Please do not send anything for repair without first writing or calling to explain the problem. Also remember to include your name, address and phone number with a brief description of the problem.

REGISTER MY SYSTEM... WHY?

By registering your Power Cab™ or Smart Booster DCC system with us you will receive personal notification of any software and hardware updates. At various times we provide free updates to our customers. At other times there is a nominal charge to cover shipping and handling (usually about \$5 to \$10). We do NOT use your name or address for any purpose other than upgrade notification. We will not sell or otherwise provide your personal information to any other person, company or entity.

ABOUT THIS MANUAL

This manual covers the installation and operation of the NCE Power Cab™ DCC system. It is not a comprehensive tutorial on all the aspects of Digital Command Control. It is not necessary to know the inner workings of DCC to use this system. Some users may wish to delve deeper into the how and why of Digital Command Control for model railroads, especially those wishing to use the computer interface of the Power Cab™. For those interested in the “nuts and bolts” we recommend the reading of the following NMRA Standards and Recommended Practices as they pertain to DCC. Applicable standards are: S-9, S9.1 and S-9.2 and Recommended Practices: RP-9.1.1 through RP-9.2.4. These documents are available via the Internet at www.nmra.org.

Editorial help has been provided by Lou Nost of Penfield, New York. The NCE Publications Department wrote this manual. Please address comments regarding the manual to:

NCE Publications Dept.
82 East Main St.
Webster, NY 14580
support@ncecorporation.com

Power Cab™

~ The Finest in Digital Command Control ~

System Reference Manual

for Power Cab™

V 1.65

Copyright 2015

NCE Corporation

82 East Main St.
Webster, NY 14580
(585) 265-0230

TABLE OF CONTENTS

QUICK START	1
COMPLETING THE QUICK START	2
PROGRAMMING A LOCOMOTIVE ADDRESS	2
RUNNING TWO LOCOMOTIVES WITH ONE CAB	3
CUSTOMER SERVICE	4
REGISTER MY SYSTEM... WHY?	4
TABLE OF CONTENTS	6
INSTALLING DECODERS	8
PRECAUTIONARY NOTES FOR DECODERS	9
GENERAL SYSTEM INSTALLATION	10
DEVICE LOCATIONS	10
PROGRAMMING TRACK	10
NCE AUTO SWITCH	11
REVERSE BLOCKS, WYES, AND CROSSOVERS	11
WIRING	11
SYSTEM POWER PANEL DESCRIPTION	12
THE POWER CAB™ SYSTEM UNIT	13
SET THE PRO CAB™ ADDRESS	14
THE LCD SCREEN	14
LOCOMOTIVE CONTROL AREA	14
SPEED CONTROL SECTION	15
COMMONLY USED BUTTONS	15
LOCO AND ACCESSORY SELECTION GROUP	16
DATA ENTRY/FUNCTION CONTROL	16
CONSIST SETUP GROUP	16
PROGRAMMING AND EXTENDED FUNCTION CONTROL	17
CAB SETUP	18
CAB BUTTON NUMBERING SCHEME	20
TABLE OF FACTORY DEFAULT VALUES	21
6 WIRE CAB BUS CABLE WITH RJ-12 CONNECTORS	21
4 WIRE CAB BUS CABLE WITH RJ-12 CONNECTORS	22
POWER CAB™ SPECIFICATIONS	22
OPERATING PROCEDURES	23
THE "NORMAL" DISPLAY	23
SELECTING A LOCOMOTIVE OR CONSIST	23
CONTROLLING HEADLIGHTS AND OTHER DECODER FUNCTIONS	24
OLD AND ADVANCED CONSISTS EXPLAINED	25
ADVANCED CONSISTS	25
OLD STYLE CONSISTS (ALSO CALLED BRUTE FORCE OR UNIVERSAL)	25
SETTING UP AN ADVANCED CONSIST	25
DROPPING A LOCOMOTIVE FROM AN ADVANCED CONSIST	27
ADDING A LOCO TO AN ADVANCED CONSIST	27
CLEARING AN ADVANCED CONSIST	28
CHANGING THE LEAD/REAR LOCO	28
OLD STYLE CONSISTS	29
SETUP AN OLD STYLE CONSIST	29
ADDING A REAR LOCO TO AN OLD STYLE CONSIST	29
CLEARING AN OLD STYLE CONSIST	30
CONTROLLING TURNOUTS AND OTHER ACCESSORIES	31
MOMENTUM BUTTON	32
USING MACROS TO CONTROL TURNOUTS	33
MACROS EXPLAINED	33
PROGRAMMING PROCEDURES	34
ACCESSING PROGRAMMING MODES	34
PROGRAMMING MENUS TABLE OF CONTENTS	35
PROGRAMMING ON THE MAIN	37

ASSIGNING A LOCO TO A CAB	44
SET THE SYSTEM CLOCK.....	44
USE PROGRAM TRACK.....	46
SETUP COMMAND STATION	55
SETTING THE CAB PARAMETERS	57
PROGRAM ACCESSORY DECODERS ON THE MAIN	59
PROGRAM MACROS	59
BROWSE CONSISTS	61
PROGRAM SIGNAL DECODERS	61
HELPFUL HINTS	62
TROUBLE SHOOTING	63
COPYRIGHTS	64
WARRANTY	64
FCC STATEMENT	65
ABOUT NCE	65
MENU NAVIGATION CHARTS	BACK COVER

INSTALLING HARD WIRED DECODERS

Locomotive decoders come as convenient plug-in models (usually designed for one specific loco or family of locomotives) or as lower cost "hard wired" types that can be wired directly to many different locomotives. Below is a description of a typical hard wired installation.

Read the following section on decoders before starting. There are shortcuts to temporary installations of the other components, but do not shortcut the decoder. We recommend you get your first decoder installed by a dealer or locomotive manufacturer just so you have a good example of how it's done.

The most important part of a successful decoder installation is proper isolation of both motor brushes from the track so that they are driven only by the decoder. Failure to isolate will definitely damage the decoder. Damage caused by failure to isolate the motor is not covered by the guarantee or warranty.

We find it preferable to mount the decoder with 1/2" wide 3M photo-mount double sided foam tape (we get ours at the local supermarket).

Before test running your newly converted locomotive on full power double check your wiring to make sure the motor is fully isolated and that there are no pinched or broken wires. We see many decoders returned due to wires getting pinched between the body shell and frame causing shorts.

Due to the high in-rush current of incandescent grain-of-wheat type bulbs (about 10 times the normal operating current) we have rated the decoder function outputs at 100mA each. We recommend Miniaturics part number 18-014-10 (2.4mm diameter 14 volt/30mA) bulbs for good results. If you are running higher voltages you will need to use 16 or 18 volt bulbs.

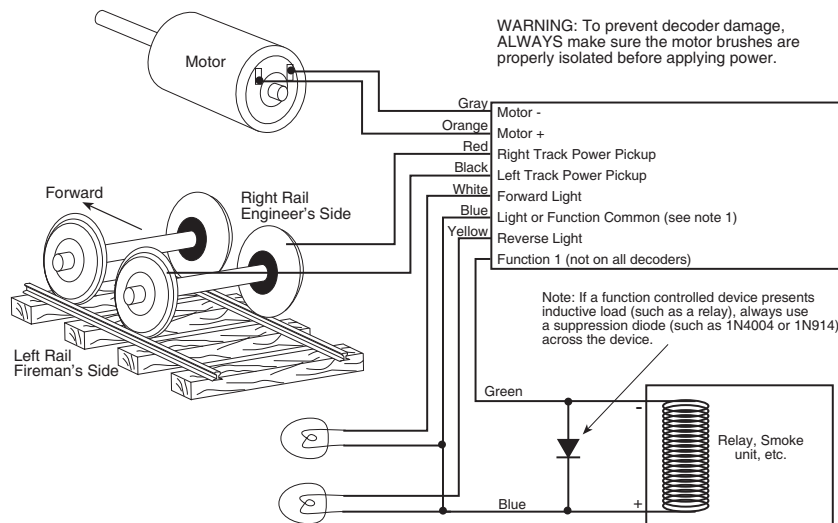

Note 1: The function common (blue wire) is the positive lead providing rectified DC voltage. If you elect to NOT use the common, power the light or other device from either track power pickup for "half-wave" operation (approx. 1/2 voltage).

If you need to use higher current lamps (50-150mA) we recommend a 22 ohm 1/4 Watt resistor in series with each bulb (this will also greatly extend bulb life). The function outputs are rated at 150mA continuous if used with LEDs or other low in-rush devices.

Always make sure the motor is isolated from the frame. Always make sure metal couplers are isolated from the frame.

PRECAUTIONARY NOTES FOR DECODERS

- MAKE SURE NO METAL PART OF THE LOCOMOTIVE TOUCHES ANY METAL PART OF THE DECODER. APPLY ELECTRICAL TAPE TO THE INTERIOR OF THE LOCO AT ANY QUESTIONABLE POINTS.
- THERE MUST BE NO ELECTRICAL CONNECTION BETWEEN THE MOTOR AND THE RAILS. BOTH MOTOR TERMINALS MUST BE ELECTRICALLY ISOLATED FROM THE MOTOR FRAME AND BODY.
- IF YOU USE METAL COUPLERS MAKE SURE THE COUPLERS ARE INSULATED FROM THE FRAME. THIS CAN CAUSE MYSTERIOUS PROBLEMS WHEN RUNNING TWO OR MORE LOCOMOTIVES COUPLED TOGETHER.
- DO NOT USE CONVENTIONAL (older) DECODERS WITH CORELESS MOTORS.

NCE decoders that are designated SR (Silent Running) are high frequency motor drive decoders. These will not harm coreless motors.

- Test the locomotive to assure good analog (DC) operation. Poor running locomotives will not run well with DCC either. Test the loco under a "stalled" condition. First connect ammeter between the DC power supply and the track. Remove the loco's shell. Increase power to the loco until it reaches at least 12 Volts. Now stall the motor by squeezing the flywheel until it stops. With locomotives without flywheels, push down on the mechanism until the wheels stop turning. Note the reading on the meter. The decoder rating needs to exceed the highest amperage reading otherwise the decoder will cause the loco to have intermittent stops when operating at the decoders' rated amperage.
- We suggest installing the wiring harnesses with plugs for all leads being used in order to facilitate decoder removal in the future.
- Lights and motor stall current should not exceed the values listed for each decoder. Nor should their total exceed the amount of current remaining after testing the loco motor "stalled". The Function common (blue wire), is track voltage.
- Make a wiring diagram of your locomotive's motor power and lighting. Copy it and show how you are going to insulate the motor from the frame, if it is not already insulated, and where you are going to cut the wires from the track pickups to the motor and lights. LGB locomotives can be tricky here.
- The power for the Functions normally is connected to the Blue wire. This will supply the lights with 14-15 volts (for the NORMAL setting). If you connect one wire of a light bulb to one of the rails (Red or Black) and the other wire to the function wire, the voltage to the lights will be cut to half the normal voltage (7 - 8 volts).
- Place the loco on the programming track and refer to the section "PROGRAMMING ON THE PROGRAMMING TRACK". Almost all decoders come from the factory with the short address "3".

When wiring, the right hand rail is the rail to the right of the observer standing between the rails with their back to the front of the locomotive, also referred to as the "engineers side". For traction systems, the overhead wire is considered the right hand rail.

GENERAL SYSTEM INSTALLATION

DEVICE LOCATIONS

The physical locations for the Power Cab™ can be anywhere. We *suggest* a location where the LED on the front of the Power Panel can be easily seen should there be a problem. Cab Bus panels such as the UTP or UTP-DIN are set up to use prewired four or six wire RJ12 telephone type cables to connect from panel to panel behind the layout fascia. Page 21 has a diagram of the proper wiring for these cables. We recommend placing the panels about 7-8 feet apart. In yard areas closer spacing may be needed. We suggest that a plug be no more than three feet from any siding where an operator would most likely stop and spend some time. Consider that operators will tend to gather at these panels so placement in crowded aisles may require care.

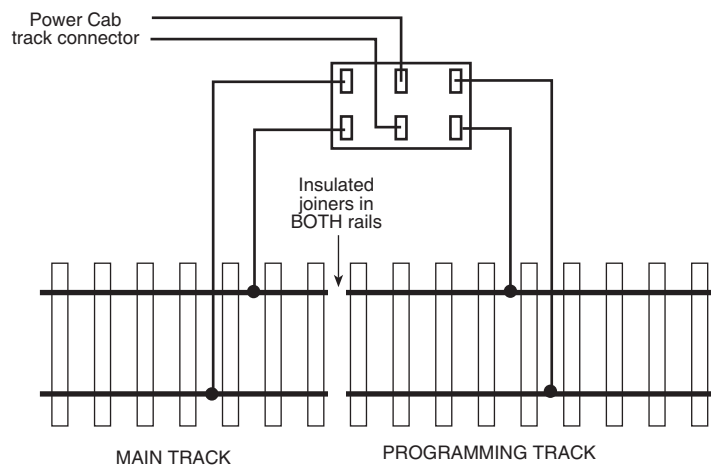

A SEPARATE PROGRAMMING TRACK

The programming track is a separate section of track where programming (setting the locomotive address and/or other internal parameters) takes place. The programming track must be electrically separate from the main trackage. The end of a convenient spur track will work fine. Install insulated joiners in both rails, directly across the track from each other. Allow enough length for your longest locomotive.

If desired, the programming track can be connected with a double-pole double-throw switch that is used to isolate this segment from the rest of your layout. This track is needed to complete the necessary start up programming for most decoder-equipped locos.

When the switch is set to use the programming track, the remainder of the layout is stopped. With NCE decoders, all parameters can be changed on the mainline using the "Programming on the Main" feature, without shutting down the whole layout. Some other manufacturer's decoders do not support "Programming on the Main" so a programming track is required. Some owners have setup their shop loop to be DC, DCC, and programming track, then they can do all the testing in their shop and have only ready-to-run loco's on the layout.

You can use the optional NCE Auto SW to automatically turn off your mainline track and let you program one locomotive at a time on your program track. Part number 524-226 is the Auto SW. When the Auto-SW is set to mainline, the program track will be off.

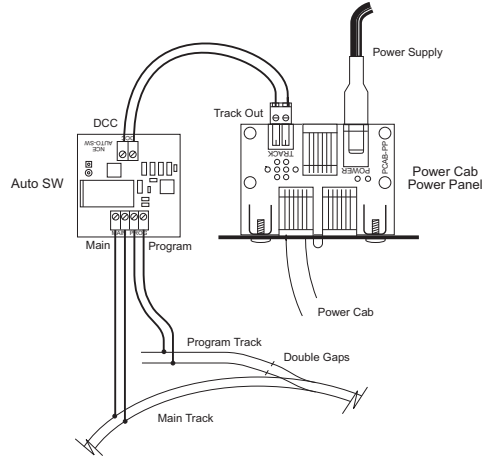

Installation of the Auto-SW to the Power Cab™ System

REVERSE BLOCKS, WYES, AND CROSSOVERS

Reversing loops/sections still present the same potential for short circuits as conventional DC layouts. You can use commercial auto-reverse loop modules such as the MRC AD520 or Tony's Trains Auto Reverser.

WIRING

If you already have a layout, your existing wiring most likely can be used without problems as long as it can handle a continuous 2 amp current. We suggest a "bus" of two large gauge (18 AWG) wires that follow the general track route of your layout with feeder wires to the track about every 3-6 feet. For the most trouble free operation we suggest a feeder to EVERY piece of rail. Don't rely on the rail joiners to handle 2 Amps of current. To prevent voltage drop over long runs a chart of recommended track bus wire sizes is found below.

For the hobbyist wiring up a new layout our suggested wire sizes based on voltage drop are:

- Runs to twenty-five feet #18
- Runs to fifty feet #16

For best results on long runs (over 20 feet), twist the bus wires about three turns per foot.

If you are planning a layout expansion that will require more power (more trains) in the future, we suggest using #16 for runs to 25 feet and #14 for longer runs.

There is no special requirement for routing the power conductors with DCC. If you are going to have long runs of cab bus cabling along the front of the layout you should run the track bus wires nearer the rear to prevent potential "crosstalk" between the track signal and the cab bus.

SYSTEM POWER PANEL DESCRIPTION

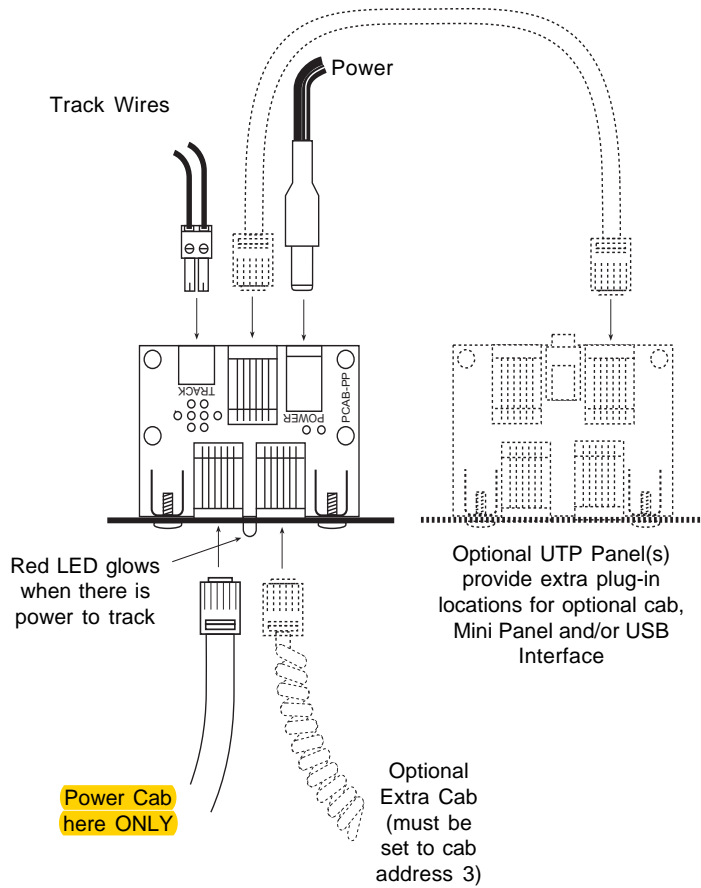

NOTES:

- The Power Cab™ will deliver track power only if it is plugged in to the **LEFT** socket. With the flat, 6-wire cable.
- Use only the provided P114 power supply or a voltage regulated 10-15 VDC supply of 3 Amps or less.
- The flat **6 wire** cable carries track power from the Power Cab™ to the Power Panel™. Use this cable for Power Cab™ operations.
- The **4 wire coilcord DOES NOT** carry track power. Use this cable when you use the Power Cab™ as a Pro Cab™ on another system.

THE POWER CAB™

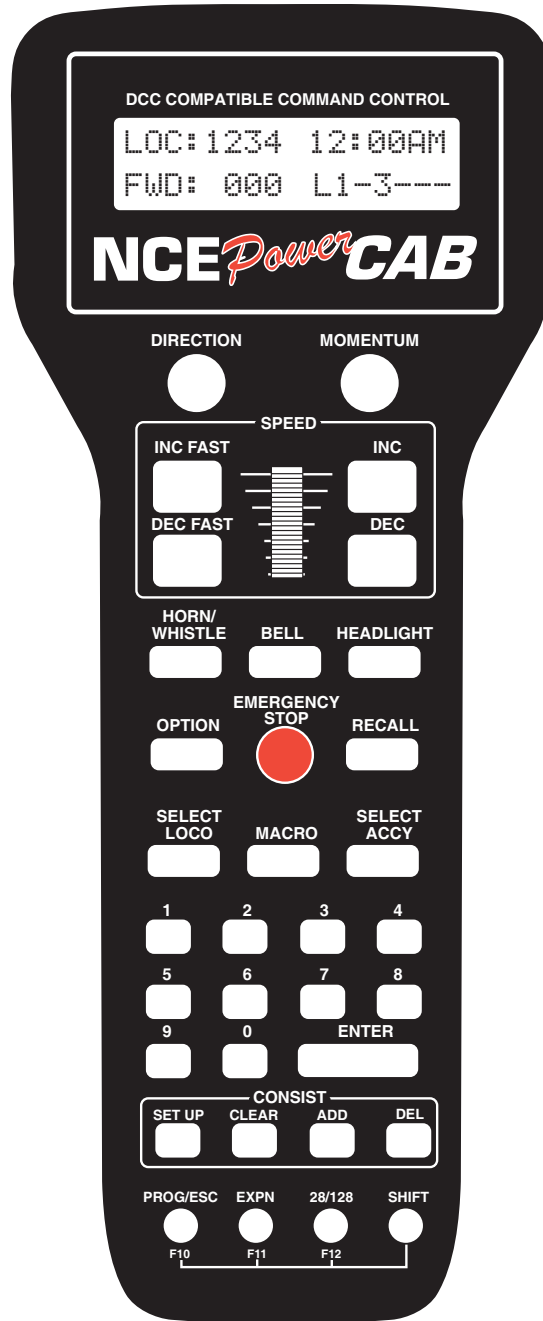

SET THE PROCAB ADDRESS -

If the Power Cab is to be used as a Pro Cab™

Just as every locomotive has a separate number (address in DCC terms) each cab needs a separate address so the command station can distinguish one cab from another. Each Power Cab™ is shipped from the factory with the address of 2. When the Power Cab™ is used in Power Cab™ mode, the address is always 2 regardless of the Pro Cab™ address setting. To easily change the address:

1. Power up your Power Cab™ system.
2. Plug in the Power Cab™ cable to the CAB BUS connector of the Power Cab™
3. Unplug your Power Cab™ at the base of the cab
4. Press and hold the **SELECT LOCO** button while re-plugging in the cable you just removed from the cab
5. You should see the following display on the cab:



```
NCE PROCAB V1.3
CAB ADDRESS = 02
```

6. The cursor will be flashing over the 0 of "02". Type in the new cab number. In this case, you will press "3" (valid range = 1-63) followed by **ENTER**.
7. Press **PROG/ESC** to skip setting all the other cab setup options. They will be discussed later on page 20 of this manual.

THE LCD SCREEN

The LCD screen provides you with messages from the Power Cab™ Command Station. This information includes: locomotive status, scale time, command prompts and messages regarding programming decoders. The drawing above shows how the display looks during normal operation. The top

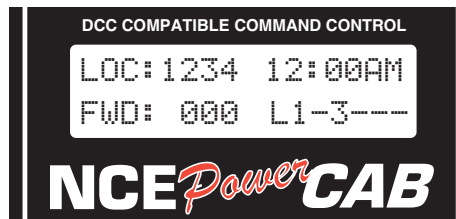

line of the display includes the locomotive number being controlled and the scale time. The second line shows the direction, speed and status of the locomotive function outputs. Decoder functions are represented with "L" for headlight or the function number 1 through 6 being ON. A dash ("-") indicating the function is OFF

LOCOMOTIVE CONTROL AREA

DIRECTION

The **DIR** key changes the direction of your loco or consist. The current direction is displayed as the first three characters of the second line on the screen. This button is disabled if the cab is in Yard mode.



Holding down the **DIRECTION** button while turning the system on will cause it to immediately go to Power Cab™ mode.

MOMENTUM

This key changes the acceleration/deceleration rate of the currently controlled locomotive/consist.

SPEED CONTROL SECTION

The digital encoder equipped Power Cab™ allows you to use both the speed buttons and the knob for controlling the speed of your locomotive. The left two keys increase or decrease the speed by either 4 or 10 speed steps, depending on the speed step mode (28 or 128), whereas the right keys increase and decrease the speed by one speed step at a time.

The knob increases the speed by rotating it up and decreases the speed when it is rotated down.

Power Cabs™ have a feature called ballistic tracking. The faster you rotate the knob the faster it will increase or decrease the speed. This rate is adjustable from 0-7. The factory default value is 3. See the Cab Setup section later in this manual.

Note: Speed buttons are disabled if the Power Cab™ is in Yard mode.

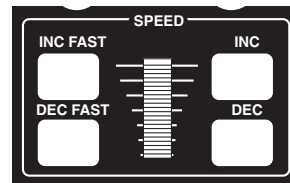

COMMONLY USED BUTTONS

HORN/WHISTLE

Factory default is to operate function 2 when this button is pushed. Unlike other keys which toggle functions on/off this key blows the horn as long as the key is held down. Pressing the **2** key will still toggle the function on or off.

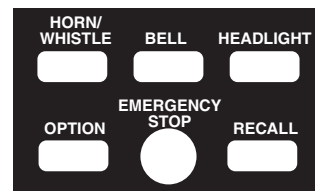

BELL

Factory default is a toggle for function "1" on or off with each button press. This can be changed in the **Set Cab Params** menu.

HEADLIGHT

Toggles the Headlight on and off. With DCC, the headlight is defined as Function 0, and pressing the 0 (zero) key will perform the same function, but we felt the headlight warranted its own button and a more convenient location.

OPTION

This button can be programmed to act as any button you wish (see the CAB SETUP section on page 18, step 8).

EMERGENCY STOP

Pressing **EMERGENCY STOP** will stop the active loco/consist for this Cab only. Speed will be immediately set to zero (no momentum). Loco is restarted by changing the speed step or direction.

RECALL

This button toggles between the last two to six locomotives or consists addressed. **RECALL** allows you to keep two to six locomotives and/or consists active in the command station memory and access them in "round-robin" fashion with each press of the button. Think of **RECALL** as being a set of memory slots. To put a locomotive in a recall "slot", press **SELECT LOCO** and enter the loco or consist to be operated followed by pressing **ENTER**. To put another locomotive in the next slot, **first press RECALL** to access the next slot. Now press **SELECT LOCO** and enter the second loco followed by pressing **ENTER**. When additional trains are to be added either a "slot" with "000" or an expendable loco/consist must be displayed on the screen. **Whatever is on the display will be replaced with the new loco/consist.**

The number of RECALLS for each cab can be changed within the "SET CAB PARAMS" menu (see PROG button description). The factory default value is two. You may also "clear out" any locomotives in the recall slots using the "SET CAB PARAMS" menu. We don't advise using RECALL in Yard mode. Because the 'DIRECTION' can be fouled inside the ProCab.

LOCO and ACCESSORY SELECTION GROUP

SELECT LOCO

This allows the selection of a locomotive/consist to operate. Press this key, the loco/consist number, then **ENTER**.



When loco is selected, Speed Step 0 and Functions 0 through 8 commands are sent to the loco. This serves to "Wake Up" sound decoders.

MACRO

When this key is pressed you are prompted to enter the macro number, then press **ENTER**. Macros are used to control one or more accessories with a single command.

This is especially useful for selecting a route through a switch ladder in a staging yard or complex trackwork where it would be inefficient to throw several switches by selecting them individually. Macros are explained in detail later on page 33.

SELECT ACCESSORY

For controlling "accessory" decoders that operate accessories such as switch machines, lights, signals, etc.

DATA ENTRY/FUNCTION CONTROL

NUMBER KEYS

The keys **0** through **9** serve two purposes. First, when operating a loco/consist if a number key is pressed it toggles the corresponding function on the loco (if that function is connected and supported by the decoder). The second purpose is for typing in numbers such as when selecting locomotives or responding to screen prompts during programming.

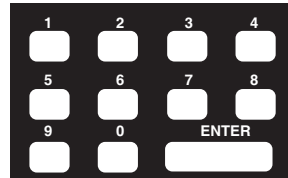

ENTER

Used to confirm numeric inputs or select a programming mode.

CONSIST SETUP GROUP

Supports not only advanced decoders that respond to the Extended Packet Format but also the older entry-level decoders. For complete operating instructions on consist makeup read the section on **SETTING UP A CONSIST** on page 25.



SETUP

Starts the procedure for either creating an advanced or old style (some call it Universal) consist.

CLEAR

Disbands (breaks up) a consist.

ADD [LOCO]

Adds a locomotive to a consist.

DELETE [LOCO]

Drops a locomotive from a consist. For use with Advanced Consists ONLY (this button is inactive with old style consists).

PROGRAMMING and EXTENDED FUNCTION CONTROL

PROG/ESC/F10

Provides selection of the various system menus available for setting up decoders, cabs, time, etc.

This button also doubles as an “escape” key during number/data entry. Whenever the cursor (flashing rectangular box) is shown on the cab display to indicate the cab is waiting for data to be input you can press **PROG/ESC** to cancel the data entry and return to normal operations.

The following menus are accessed round robin with each successive press of the **PROG/ESC** key when in normal operations:

- First press: Program on the Main (Operations Mode programming)
- Second Press: Assign loco to Cab
- Third Press: Set Fast Clock
- Fourth Press: Use programming Track
- Fifth Press: Set up Command Station
- Sixth Press: Set up Cab Parameters
- Seventh Press: Program accessory decoders on the mainline
- Eighth Press: Set up Macros (switch route control)
- Ninth press: Browse Advanced Consists
- Tenth press: Program Signal decoders on the mainline

Pressing **ENTER** at any of the above menus will select that menu, pressing **PROG/ESC** will step to the next menu. You can use ‘shortcuts’ to get to the menus you like. For example: Pressing **PROG/ESC** followed by 4 takes you to the Program Track menu.

Pressing **SHIFT** and **PROG/ESC** activates F10.

EXPN/F11

In Power Cab™ mode, this button is reserved for future features. When the Power Cab is used as a wireless Pro Cab, this button is used to access the radio setup menu. When the cab is tethered, it toggles between the display of lines 1 and 2 of the LCD display and lines 3 and 4. Pressing **SHIFT** and **EXPN** activates F11.

Pressing the **EXPN** key will show the status of functions 1 through 28. The top line of the screen shows functions 1-14, ‘-’ means the function is off. A digit in the space means the function is on. The second line of the screen shows functions 15 through

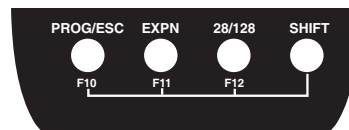

28 in the same manner. Pressing the **EXPN** key a second time returns the cab to the normal display.

28/128/F12

Provides the ability to toggle between 28 and 128 speed step operation of the active loco/consist. Pressing this button will display the speed step mode you have selected on the cab LCD. The LCD display will be set to the normal operation display the next time a function is toggled or **ENTER** is pressed. Pressing **SHIFT** and **28/128** activates F12. When the Power Cab™ is turned off, the default is set to 28 speed steps.

SHIFT

This button gives each key on the ProCab an “alter ego”. When pressed and held while pressing another key on the cab the alternate value of that key can be used. For example: To access the function F10 you simply press **SHIFT** and **PROG/ESC** at the same time to activate FUNCTION 10. Every key can be programmed to any current or future feature we may think up. This is like having a whole cab full of **OPTION** keys. Each key is preprogrammed at the factory to one of these alternate uses. Try pressing **SHIFT** and 4. This takes you directly to the **USE THE PROGRAMMING TRACK** menu. A list of the shifted keys is tabulated on page 21.

EXTENDED FUNCTION CONTROL (F10 - F28)

Control of functions **F13** through **F28** has been added. To access these function numbers program the **OPTION** key to a value of **122** (see **CAB SET UP**, below). Pressing **OPTION** will display “**F10** through **F19**” on the bottom line of the cab. Pressing a digit will toggle that number plus ten. For example, pressing **6** will issue an **F16** command.

Pressing **OPTION** a second time will display “**F21** through **F28**” on the cab. Pressing a digit with this display will toggle that number plus twenty.

Pressing **OPTION** a third time will return to the **F10** through **F19** display. Pressing **Prog/Esc** at any time will abort the operation.

CAB SETUP

The Power Cab™ has various internal setup parameters and operating modes. Most of the settings apply to both Pro Cab™ and Power Cab™ modes of operation. The following steps describe the parameters you can change to customize the cab to your liking.

To access the cab set up mode:

- 1) Turn on the system power.
- 2) Unplug your cab from the Power Panel.
- 3) Press and hold down the **SELECT LOCO** button while plugging in the cab. The cab will now enter its internal setup program. At any time you may press **PROG/ESC** to leave set up mode.
- 4) Press **ENTER** to accept the current cab address (unless you want to change it). To change the cab address, type in a new address such as 3 followed by the **ENTER** key. If you make a mistake just unplug the cab and re-plug it while holding down the **SELECT LOCO** key.

NOTE: If you program the address to zero the cab will reprogram itself to the original factory values, including the cab address, which will be set to 2.

- 5) At the “1=YARD 2=NORMAL” prompt you can press **ENTER** to accept the current operating mode. Yard mode only works in Pro Cab™. To select between “normal” operation where the speed knob stops at speed 0 when turned all the way down or “yard” mode. In yard mode as the knob is turned down to zero it will reverse locomotive direction and start increasing speed in reverse as the knob turning in

the “down” direction is continued. Pushing the knob up will reduce the reverse speed to zero then increase it in a forward direction. **The factory setting is 2 for “normal” Operation**

- 6) Press **ENTER** to accept the existing Ballistic Tracking Rate or enter a new rate. Entering a low number will cause the speed knob to change locomotive speed more slowly as the knob is turned. Larger numbers will cause a greater change of speed as the knob is turned. **The factory setting is 3 and values from 0-7 will be accepted.**
- 7) Press **ENTER** to accept the Speed Button Repeat Rate. This is the rate at which the 4 speed control buttons repeat. Smaller values will make the buttons repeat faster. The acceptable range is 16 to 255. **The factory setting is 32.**
- 8) Press **ENTER** to accept the current OPTION key value. If you wish to change it enter a number from the Key Table Chart following this section. **The factory value is 94** so the OPTION button will act as BRAKE button.
- 9) Press **ENTER** to accept the “shifted” value for key number 1. If you wish to change it enter a number from the Key Table Chart following this section. See the Table of Factory Default Values for Shifted Keys on page 21 for the preset factory values.
- 10) Use the same procedure described in step 9 to accept or program keys number 2 through 32. Remember you can press PROG/ESC to exit at any time. If you stick it out to key 32, press **ENTER** to return to normal operations mode.

Key Table Chart

Value	Key Name	Value	Key Name
64	Enter	96	Assign Loco to Cab
65	Program	97	Program on Main
66	Recall	98	Set Clock
67	Direction	99	Use program track
68	Setup consist	100	Setup command station
69	Add loco to consist	101	Setup Procab
70	Delete loco from consist	102	Setup macros
71	Kill consist	103	Setup old consist
72	Select loco	104	Setup advanced consist
73	Horn/Whistle	105	Display LCD lines 3 and 4
74	1 Speed step faster	106	Forward
75	1 Speed step slower	107	Reverse
76	Emergency Stop	108	Reserved
77	Bell	109	Reserved
78	Select Accessory	110	Reserved
79	Expn (Expansion) key	111	Momentum
80	Headlight, Zero key	112	F10
81	F1, number 1 key	113	F11
82	F2, number 2 key	114	F12
83	F3, number 3 key	115	Reserved
84	F4, number 4 key	116	Reserved
85	F5, number 5 key	117	Reserved
86	F6, number 6 key	118	Reserved
87	F7, number 7 key	119	Reserved
88	F8, number 8 key	120	Reserved
89	F9, number 9 key	121	Reserved
90	4/10 speed steps faster	122	Extended Function Control
91	4/10 speed steps slower	123	Aux Analog Button Down
92	Macro	124	Aux Analog Button Up
93	14/28/128 select	125	“no key” pressed
94	Brake (factory setting)	126	Reserved
95	Do not use	127	do not use

Power Cab™ BUTTON NUMBERING SCHEME

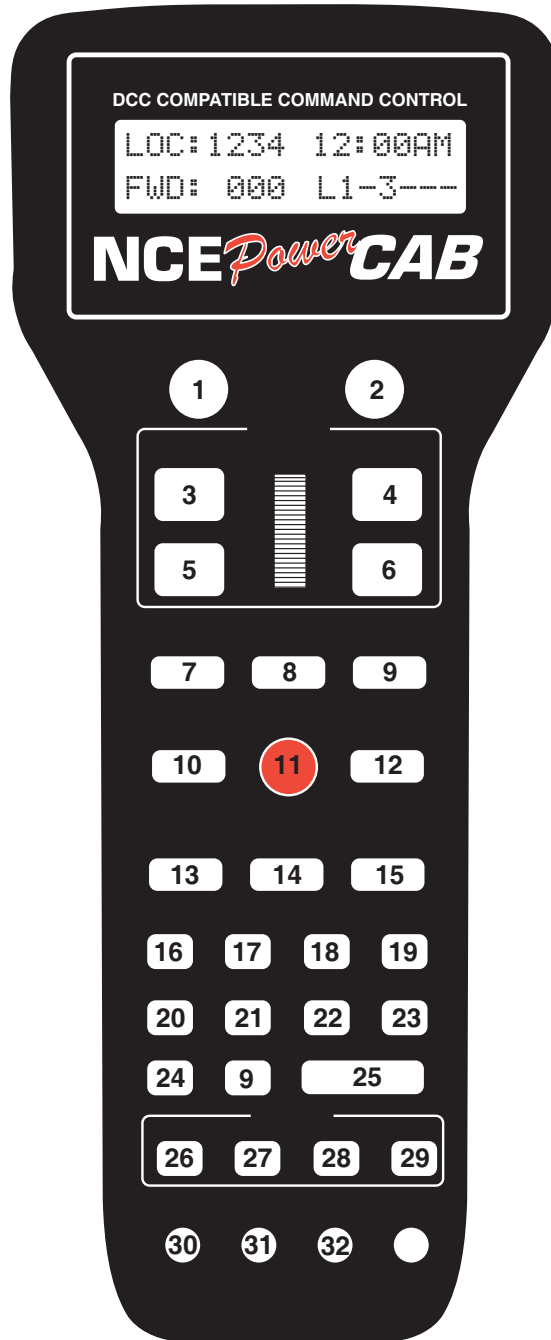
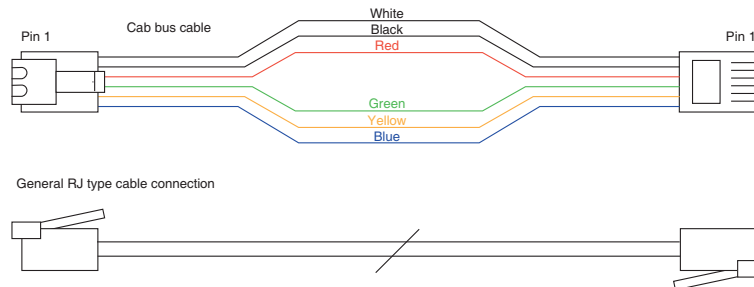

TABLE OF FACTORY DEFAULT VALUES FOR “SHIFTED” KEYS

Key #	Value	Description	Key #	Value	Description
1	67	Direction	17	96	Assign Loco -> Cab
2	94	Brake	18	98	Set Clock
3	90	Increment 4/10 steps	19	99	Use Program Track
4	74	Increment 1 Step	20	100	Setup Command Station
5	91	Decrement 4/10 steps	21	101	Setup Cab Parameters
6	75	Decrement 1 Step	22	118	Reserved
7	123	reserved	23	102	Setup Macros
8	81	Headlight	24	108	Reserved
9	122	reserved	25	119	Reserved
10	125	reserved	26	103	Setup Old Consist
11	116	reserved	27	108	Reserved
12	109	reserved	28	120	Reserved
13	121	reserved	29	115	Reserved
14	117	reserved	30	112	Function 10
15	111	Momentum	31	113	Function 11
16	97	Program on Main	32	114	Function 12



6 WIRE CAB BUS CABLE WITH RJ-12 CONNECTORS

Pin #	Color	Description
Pin 1	White	Power to track
Pin 2	Black	Ground
Pin 3	Red	- RS-485
Pin 4	Green	+ RS-485
Pin 5	Yellow	+12 volts
Pin 6	Blue	Power to track

4 WIRE CAB BUS CABLE WITH RJ-12 CONNECTORS

****To prevent potential damage, ALWAYS use 4 wire cables when your Power Cab is used as a Pro Cab. This keeps Power Cab track power from interfering with the NCE cab bus.**

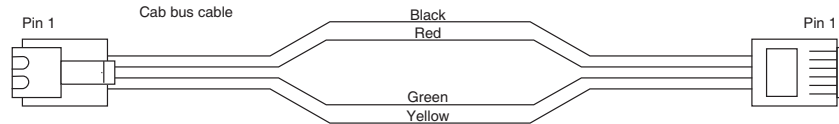

General RJ type cable connection

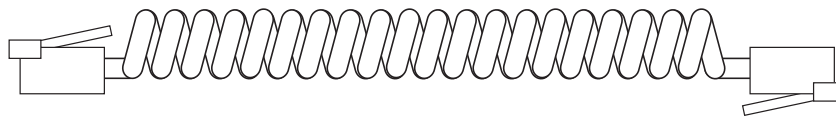

Pin #	Color	Description
Pin 1	White	Unused
Pin 2	Black	Ground
Pin 3	Red	- RS-485
Pin 4	Green	+ RS-485
Pin 5	Yellow	+12 volts
Pin 6	Blue	Unused

NOTE: Pro Cab mode cables only need the center four wires for proper operation.

Power Cab™ Specifications:

Power Input Requirements: 10-15V regulated DC, 3A maximum
Power Connector: 5.5mm x 2.5mm center positive
Track Power Output: Voltage input minus (-) .5 Volt 2 Amps peak
Cabs: 2 maximum plus USB Interface and/or Mini Panel
Number of simultaneous trains: 12
Number of consists: 16 advanced consists of unlimited number of locomotives each. Plus 4 old style consists up to 2 locos each.
Range of locomotive addresses: 0-9999
Range of consist addresses: 112-127
Range of accessory addresses: 1-2044
Range of signal addresses: 1-2044
Computer interface: USB optional

Pro Cab™ Mode Specifications:

When the Power Cab is used as a Pro Cab, the following specifications apply.

Size: 8-3/4 x 3-5/8" x 1"

Power Requirements: 8 VDC 40mA (backlight off) 8 VDC 120mA (backlight on)

Replacement Encoder: Bournes or Digikey part #3315C-1-006

Speed control: Thumbwheel operated digital encoder with adjustable ballistic tracking rate. Pushbutton speed control with adjustable auto-repeat rate (4 pulses per second to one pulse per 4 seconds).

Backlit LCD Display: 2 line by 16 characters/line. Two extra display lines available for display of additional information when used with computer dispatcher programs.

OPERATING PROCEDURES

THE "NORMAL" DISPLAY

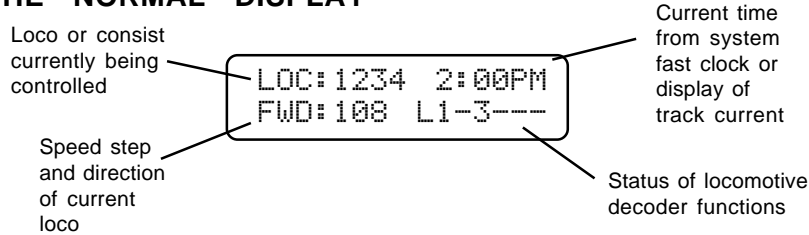

TOP ROW OF DISPLAY

LOC: Indicates that a locomotive is being operated.
CON: Indicates that a consist is being operated.
2:00PM: Scale Time in either 12 hour or 24 hour format.

BOTTOM ROW OF DISPLAY

FWD: or REV: Indicates the current direction of loco or consist
108 - Indicates the speed step to which the active loco/consist is presently set.
L123456 or - - - - -
Indicates which function outputs are ON. Those outputs that are OFF are displayed as dashes (-). The example above indicates that the Headlight, Function #1 and Function #3 are on.
Other status information may temporarily be displayed in this area.

SELECTING A LOCOMOTIVE OR CONSIST

First a word about locomotive addresses. A decoder can have 2 different addresses, the Short Address (values from 1-127) and the Long Address (sometimes called 4 digit with a range of 0000-9999). A decoder can use one or the other but not both at the same time. Some entry level decoders can only use the Short Address.

As you can see above there is an overlap in the address ranges between the short and long address. You can have a **Long Address** of 6 and a **Short Address** of 6. They are *not* the same. To use a short address (range 1-127) it is selected on the cab by entering only the significant digits (no zeros before you get to the numbers). To enter a long address in the range of 0-127 put a zero before the digits. A long address between 0 and 127 will have an asterisk (*) before the loco address on the cab display as below:

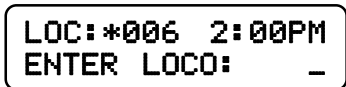

NOTE: You will notice that the short address 0 is not available but the long address 0 is listed as a valid address. Short address 0 is the "broadcast" address for DCC. If you were to send commands to short address 0 all locomotives on the layout would respond causing chaos. For this reason we don't allow use of short address 0. Long address 0 can be used just like any other locomotive address.

To select a locomotive for operation:

- Press the **SELECT LOCO** button
- Enter the 1 to 4 digit address of the loco/consist to be operated. A “Leading Zero” is necessary for **long** addresses below 128. An asterisk will be displayed before any long address below 128 (example below).
- Press the **ENTER** key.

Locomotive address examples:

4421 = Long Address

006 = Long Address as entered.

*006 = Long Address as displayed

45 = Short Address as entered

045 = Short Address as displayed

LOC: will be displayed when addressing a single locomotive

CON: will be displayed when addressing a Consist.

CONTROLLING HEADLIGHTS AND OTHER DECODER FUNCTIONS

Pressing **HEADLIGHT** will alternately toggle the headlight of the locomotive on and off.

To toggle other functions simply press the number key that corresponds to the function you wish to control. E.g. - The ‘1’ key controls function 1.

Your cab will display which functions are on and off on the lower right of the display. The letter ‘L’ stands for Headlight (Function 0) and numbers 1-6 stand for functions 1-6 (functions 7 through 12 are not displayed on the cab but work if you push the buttons). In the example below the headlight plus functions 2 and 6 are on.

```
LOC:4449  xx:xxPM  
FWD:02    L-2---6
```

OLD AND ADVANCED CONSISTS EXPLAINED

Before setting up any consist an explanation is needed to understand the operating differences between Advanced and Old Style consists (also called brute force or Universal). Basic decoders that have a short address but no CONSIST address (Early Lenz, MRC 30x/31x series and Digitrax 120 series Decoders) can not be used with advanced consisting.

ADVANCED CONSISTS

Decoders that support advanced consisting have an additional short address, the CONSIST address, in addition to their normal Long and Short addresses. The consist address is stored in CV19 and can have a value of 112-127.

A decoder considers itself in a consist if the Consist Address (CV19) is something other than 0 or 128. A decoder is added to a consist when the command station sends a command to set the consist address in the decoder to the consist number. The decoder will now use this new consist address for speed and direction commands. This has many advantages including the need for fewer communications on the track and no need for the operator or command station to keep track of which locomotives are in what consist on the layout.

Each locomotive in an advanced consist will still respond to function or programming commands using the original locomotive address. This means the operator can turn lights or other functions on or off for each locomotive individually.

To kill an entire consist, a command is broadcast on the tracks for each decoder with that consist number to clear its consist address and return to individual operation. Locomotives can also be individually dropped from a consist. You can also add locomotives to a consist after the initial set up of that consist.

Advanced style consists can easily be taken from layout to layout and they will continue to operate as a single unit.

OLD STYLE CONSISTS (also called brute force or Universal)

With an Old Style consist, the command station keeps track of each locomotive in the consist within the memory of the command station. Each speed change of the cab generates a separate speed command to **each** of the decoders in the consist. These extra speed commands on the track have significant ramifications if you have a lot of consists operating at one time as in a club situation. The effect is to slow down locomotive response to the throttle speed controls.

Use this method of building a consist with MRC and Digitrax 120 series decoders.

Decoders in an old style consist have no knowledge of being in a consist and will not operate as a unit when moved to another layout. You can add one or more advanced consists to any old style consist.

SETTING UP AN ADVANCED CONSIST

To set up a consist press **SETUP**. This screen allows you to choose the type of consist to be created. For those consists that will contain advanced decoders, press **ENTER** to select the advanced mode.

```
CONSIST 2:00PM
ENTER=ADV 1=OLD
```

An advanced consist has *no* limit to the number of loco's assigned.

NOTE: you can not setup, add, or delete a loco from a consist while the locomotive is moving. It must be at speed 0. Decoders will not accept consist commands while they are in motion. This prevents reception of false consist make/break commands due to electrical noise generated by the wheels rolling on the track.

CONSIST ADDRESS:

The consist address can be any number from 112 through 127. The system will suggest the first available consist address (the priority is highest to lowest). Press **ENTER** to accept this address.

```
SETUP    2:00PM  
CON ADDR: 127
```

You may enter any other number you wish (from 112 to 127) then press the **ENTER** key. If you have locomotives on the layout using short addresses make sure you don't pick an address already in use. This is one reason to use long addresses with your loco fleet. It will keep the short addresses free for consists.

ENTERING THE LEAD LOCO NUMBER

Entering the lead loco number is optional but recommended. The command station keeps track of consists by their lead loco number. The locomotive is the loco that the command station will send function commands to. For example: headlight on/off commands. If the command station did not know the lead loco it would not know which locomotive should have the headlight turned on or off.

The lead loco number also acts as an *alias* for the consist number entered above. Say you have a bunch of consists stored on staging tracks and you wish to operate one of them. After the consist is set up, you can select the consist by pressing **SEL LOCO** then entering either the lead loco number or the consist number. The lead loco number is typically easiest to remember because it is the number printed right on the locomotive. The consist address may not relate to any visible or easily remembered number.

```
SETUP    2:00PM  
LEAD LOCO: _
```

Enter the lead loco number followed by pressing the **ENTER** key.

ENTERING THE LEAD LOCO DIRECTION

If the locomotive is to operate in the forward direction press **ENTER**. Press the **DIRECTION** key if you wish to have the locomotive operate in the reverse direction. Subsequent presses of the **DIRECTION** key will keep changing the direction. When you get the direction you desire press the **ENTER** key.

```
CONSIST   2:00PM  
DIR THIS LOCO: F
```

This informs the decoder whether the loco is in the line-up facing forward or reverse. For instance, in an A-B-A consist the lead A unit and the B unit will be setup in the Forward direction, and the second A unit will be setup in the Reverse direction.

ENTERING THE REAR LOCO NUMBER

Entering the rear loco number is optional. The command station keeps track of consists by their lead or rear loco number. If you select the consist by the rear loco number the direction of the consist will be reversed from the direction of operation if you selected it by the lead loco. You don't have to enter a rear loco number if you don't need/want to operate the consist in reverse. The rear loco number also act as an *alias* for the consist number just as the lead loco number.

```
SETUP    2:00PM  
REAR LOCO: _
```

Enter the rear loco number followed by the **ENTER** key.
NOTE: If you plan on dropping the rear loco from the consist later on, DO NOT enter it as the rear loco. Enter it later on when prompted for mid-consist locos.

ENTERING THE REAR LOCO DIRECTION

If the locomotive is to operate in the normal direction press **ENTER**. Press the **DIRECTION** key if you wish to have the locomotive operate in the reverse direction. Subsequent presses of the **DIRECTION** key will keep changing the direction. When you get the direction you desire press the **ENTER** key.

```
CONSIST    2:00PM  
DIR THIS LOCO: F
```

ADDING A MID-CONSIST LOCO

At this point you can start to add more locomotives to the consist. Enter the next locomotive (decoder address) followed by pressing the **ENTER** key. If you don't want to add any more locomotives to the consist just press **ENTER**.

```
CONSIST 2:00PM  
ADD LOCO:  _
```

ENTERING THE LOCO'S DIRECTION

```
CONSIST    2:00PM  
DIR THIS LOCO: F
```

As with the lead locomotive, this informs the decoder if the loco is in the line-up facing forward or reverse.

If the locomotive is to operate in the normal direction press **ENTER**. Press the **DIRECTION** key if you wish to have the locomotive operate in the reverse direction. Subsequent presses of the **DIRECTION** key will keep changing the direction. When you get the direction you desire press the **ENTER** key.

At this point you will be prompted to add additional locomotives. If you don't want to add any more locomotives to the consist just press **ENTER** or **PROG/ESC** with out entering an address.

DROPPING A LOCOMOTIVE FROM AN ADVANCED CONSIST

To delete a consist locomotive press **DEL**

```
DEL LOCO 2:00PM  
ENTER LOCO:  _
```

This will drop the loco identified from whatever consist it was part of. There is no need to know the consist number for this operation. You cannot drop a lead or rear loco without clearing the entire consist. Deleting a loco sets CV19 to a value of 0 in that loco.

ADDING A LOCO TO AN ADVANCED CONSIST

Select the consist.

```
ADD LOCO 2:00PM  
CONSIST ADDR:  _
```

Press **ADD** . Enter the address of the consist, or lead loco, to which the loco is to be added and then press the **ENTER** key.

```
ADD LOCO 2:00PM
ADD LOCO:  -
```

Enter the loco number to be added and press the **ENTER** key.

Enter the loco's direction

```
CONSIST 2:00PM
DIR THIS LOCO: F
```

If the loco is to operate in the normal direction press **ENTER**, otherwise press the **DIRECTION** key followed by pressing the **ENTER** key. This informs the decoder whether the locomotive is in the line-up facing reverse.

CLEARING AN ADVANCED CONSIST

Press **CLEAR**. Select the consist to be cleared.

```
LOC:4449 2:00PM
KILL CONSIST: -
```

Enter the lead or rear loco number and press **ENTER**. This sends a command to all decoders with this consist address to clear the consist address from the decoder. You can also enter the consist address if you know it. All locomotives that were assigned to this consist will no longer respond to the consist address.

CHANGING THE LEAD/REAR LOCO

Under some circumstances it is desirable to change which locomotive is to act as the lead loco of a consist. One of these circumstances is when you want to drop the lead/rear loco from the consist. The command station will not allow you to drop the lead/rear loco so you will want to assign a new locomotive as lead/rear. Then you will be able to drop the old lead loco.

```
SETUP 2:00PM
CON ADDR:  -
```

The first step is to press **SETUP**. Then enter either the consist number of the current lead loco number (address). Then press **ENTER**.

```
SETUP 2:00PM
LEAD LOCO:  -
```

Enter the *new* lead loco number and press **ENTER**. If the new lead loco is to operate in the forward direction press **ENTER**. Press the **DIRECTION** key if you wish to have the locomotive operate in the reverse direction. When you get the direction you desire press the **ENTER** key.

```
CONSIST 2:00PM
DIR THIS LOCO: F
```

You are now finished changing the lead locomotive of the consist.

Use a similar procedure to change the rear loco.

OLD STYLE CONSISTS

SETUP AN OLD STYLE CONSIST

```
CONSIST  2:00PM  
ENTER=ADV 1=OLD
```

Press **SETUP**. This screen allows you to choose the type of consist to be created. For those consists that will contain any basic decoders, press **1**. Please note that the limit on an old style consist is two locomotives or advanced consists. **NOTE:** Once you setup an old style consist you will not be able to select a new locomotive to run unless you store the consist away by pressing recall (or clear the consist). Each cab may have up to 2 old style consists in recall.

INITIAL SCREEN DISPLAY

```
OLD TYPE 2:00PM  
CON:    000  000
```

This screen is "informational" to show all 4 "slots" for loco's in the Old Style consist. Press the **ENTER** key to continue.

ENTERING THE LEAD LOCO NUMBER

```
OLD TYPE 2:00PM  
LEAD LOCO:  _
```

Enter the loco number followed by the **ENTER** key. The first loco to be added will be the lead loco (the lead loco number will be displayed on the screen during normal operation). The consist will respond to this number.

ENTERING THE LOCO DIRECTION

```
OLD TYPE 2:00PM  
DIR THIS LOCO: F
```

The locomotive direction is assumed to be forward, if it is to operate in reverse press the **DIRECTION** key. This informs the command station the loco is in the line-up facing reverse. This affects only the direction of the loco, not lighting. Press the **ENTER** key to continue.

ADD REAR LOCO

```
OLD TYPE  2:00PM  
REAR LOCO:  _
```

Enter the second loco address followed by the **ENTER** key.

ENTERING THE LOCO DIRECTION

```
OLD TYPE 2:00PM  
DIR THIS LOCO: F
```

The locomotive direction is assumed to be forward, if it is to operate in reverse press the **DIRECTION** key. This informs the command station whether the loco is in the line-up facing reverse. This affects only the direction of the loco, not lighting. Press the **ENTER** key to continue.

This operation leaves the consist as the active unit for this Cab. By pressing **RECALL** the operator can change to another loco/consist but the old style consist will stay with this Cab until it is either passed to another Cab (by assigning it) or the consist is cleared.

OLD STYLE CONSIST FULL

```
OLD TYPE 2:00PM  
CONSIST NOW FULL
```

The consist contains two loco's which is the maximum amount that we support in this style of consist. Press the **ENTER** key to continue.

CLEARING AN OLD STYLE CONSIST

```
KILL? 02:00PM  
ENTER=NO 1=YES:
```

Press 1 to clear the consist from the Command Station memory. All locomotives that were in the consist may now be selected and operated independently.

VIEWING WHICH LOCOS ARE IN AND OLD STYLE CONSIST

Press **SETUP** - The locos and their direction will be displayed. Press **ENTER** to return to normal operation.

CONTROLLING TURNOUTS AND OTHER ACCESSORIES

ENTER THE ACCESSORY NUMBER TO BE OPERATED

```
CONTROL 02:00PM  
ACC NUMBER: -
```

Press the **SELECT ACCY** key. Enter the address of the accessory to be operated. Followed by pressing the **ENTER** key. Valid accessory addresses range from 1 to 2044.

TURN ACCESSORY ON OR OFF

```
ACC: 003 02:00PM  
1=N(ON) 2=R(OFF)
```

Press **1** to turn accessory ON. (Switch machine set to Normal)
Press **2** to turn accessory OFF. (Switch machine set to Reverse)

Note: If you are going to activate the same accessory, just “double-clicking” the **SELECT ACCY** key will activate it.

THE MOMENTUM BUTTON

When you press the momentum button you are prompted to enter a momentum level. There are 9 levels of momentum (1-9) plus 'direct drive'(0). Pressing a digit button from 0-9 will automatically set the acceleration and deceleration rates of the locomotive(s) being controlled.

Pressing 0 sets the momentum of the train to 0 effectively turning it off. 1 is the smallest amount of momentum, 9 is the most.

If you are operating an Advanced or Old Style consist setup in the command station all locomotives will have their momentum set. If an Old Style consist includes one or more Advanced consists all locomotives in the Advanced consist (up to 6 per advanced consist) will also have their momentum set properly.

Technical stuff - what happens when you set momentum

The digit entered is multiplied by 8 (factory default) and sent to CV3. The value sent to CV4 is ½ the value sent to CV3. You can change these multipliers.

You can setup the following momentum parameters in the SET CMD STA menu:

The acceleration multiplier can be set to a value in the range of 0-25.

The deceleration can be set to FULL or HALF the value sent to CV3.

You can disable the sending of momentum commands to consists.

If a decoder follows NMRA Recommended Practice 9.2.2 the rates will be as shown below with the factory default settings (multiplier = 8 and deceleration = half).

Rate 1 = 7 seconds to full speed, 3 seconds to stop

Rate 2 = 14 seconds to full speed, 7 seconds to stop

Rate 3 = 21 seconds to full speed, 10 seconds to stop

Rate 4 = 28 seconds to full speed, 14 seconds to stop

Rate 5 = 35 seconds to full speed, 17 seconds to stop

Rate 6 = 42 seconds to full speed, 21 seconds to stop

Rate 7 = 49 seconds to full speed, 24 seconds to stop

Rate 8 = 54 seconds to full speed, 27 seconds to stop

Rate 9 = 61 seconds to full speed, 30 seconds to stop

If a consist is active when MOMENTUM is pressed the button will do nothing unless "CONSIST MOMENTUM" is enabled (factory default) in the SET CMD STA menu. Momentum commands will be sent to a limit of 6 locos per Advanced consist.

Notes regarding momentum commands and decoders:

There are special commands for setting *consist* momentum (CV23 and CV24) but most decoders *do not* support these CV's.

CV3 and CV4 are **required** and have standardized values in decoders per RP-9.2.2. Support for consist CV23 and CV24 is **not required** in decoders, this is why we use CV3 and CV4 for consist momentum..

Sound equipped locomotives that verbally speak the value of CVs must be turned off by setting CV 62 to a value of 0 for momentum to work properly. Setting CV 62 to a value of 1 turns the verbal response back on.

Some European makes of decoders require locomotive power to be interrupted before the new CV values will take effect.

USING MACROS TO CONTROL TURNOUTS

MACROS EXPLAINED

Macros are really a list of turnout controlled by accessory decoders that you wish to operate as a group. There are a total of 16 macros, each one capable of controlling up to 8 turnout. Macros may be 'chained' with other macros to create complex routes with hundreds of turnout.

ENTER THE MACRO NUMBER TO BE EXECUTED

```
LOC: 1023 2:00PM  
MACRO NUMBER: -
```

- Press **MACRO** key.
- Enter the number of the macro (0-16) to be executed
- Press **ENTER**.

MACRO NOT SET UP

```
ERROR: 02:00PM  
-MACRO IS EMPTY-
```

This message will be displayed if no macro has been programmed for the number entered.

MACRO PROGRAMMING

To program a macro see the PROGRAMMING MACRO section, page 59.

PROGRAMMING PROCEDURES

ACCESSING PROGRAMMING MODES

To access the various programming modes, press the **PROG/ESC** key. The following messages will be displayed for each press of the **PROG/ESC** key. When the desired mode is displayed, press the **ENTER** key to enter that mode. To quickly get to a programming mode, press the **PROG/ESC** key and then press the number of the screen. If you have pressed the **PROG/ESC** key by mistake, or want to exit out without having to press the **PROG/ESC** key several times, press **EXPN**. Refer to the following sections for the individual programming instructions. To escape from any programming session press the **PROG** key.

To program locomotive decoders on the main (OPS mode) press **ENTER**.

```
SEL MODE 02:00PM  
PROGRAM ON MAIN
```

To assign a locomotive/consist to a Cab press **ENTER**. [2]

```
SEL MODE 02:00PM  
ASSIGN LOCO->CAB
```

To start, stop, or set the System Clock press **ENTER** [3]

```
SEL MODE 02:00PM  
SET SYSTEM CLOCK
```

To program on the program track press **ENTER**. [4]

```
SEL MODE 02:00PM  
USE PROGRAM TRK
```

To set command station parameters press **ENTER**. [5]

```
SEL MODE 02:00PM  
SET CMD STATION
```

To set the Cab parameters press **ENTER**. [6]

```
SEL MODE 02:00PM  
SET CAB PARAMS
```

To program accessory decoders on the main press **ENTER**. [7]

```
SEL MODE 02:00PM  
PROG ACCESSORIES
```

To setup macros (routing through turnouts) press **ENTER**. [8]

```
SEL MODE 02:00PM  
PROGAM MACROS
```

To browse through all the advanced consists in the system, press **ENTER** [9]

```
SEL MODE 02:00PM  
BROWSE CONSISTS
```

To program signals on the main press **ENTER**. [10]

```
SEL MODE 02:00PM  
PROGRAM SIGNALS
```

PROGRAMMING MENUS

TABLE OF CONTENTS

The following is a chart of all of the programming modes and each section within each mode. Refer to the details in the following sections.

PROGRAMMING ON THE MAIN	37
WHAT TO PROGRAM	37
ADDRESS PROGRAMMING (OPTION 1)	37
CV PROGRAMMING (OPTION 2)	38
SET DECODER CONFIGURATION (OPTION 3)	38
SET MOTOR CONTROL PARAMETERS (OPTION 4)	39
SET UP DECODER OUTPUT/FUNCTION MAPPING (OPTION 5)	41
SET UP NCE LIGHTING EFFECTS (OPTION 6)	42
QSI PROGRAMMING (OPTION 8)	43
BINARY CV PROGRAMMING (OPTION 9)	43
ASSIGNING A LOCO TO A CAB	44
ASSIGN THE LOCO	44
ASSIGN THE CAB	44
SET THE SYSTEM CLOCK	44
STOPPING THE CLOCK	44
SETTING 12 OR 24 HOUR MODE	44
ENTERING THE HOUR	44
ENTERING THE MINUTE	45
ENTERING THE RATIO	45
STARTING THE CLOCK	45
PROGRAMMING TRACK	46
PROGRAMMING OPTIONS	46
STANDARD PROGRAMMING (OPTION 1)	47
DECODER MANUFACTURER	47
DECODER VERSION	47
DISPLAY OF ACTIVE ADDRESS	48
ENTERING THE DECODER ADDRESS	48
SETTING UP BASIC DECODER CONFIGURATION (CV29)	48
DIRECTION BIT	49
SPEED STEPS	49
ANALOG MODE	49
SPEED TABLE SELECTION	49
ENABLE LONG OR SHORT ADDRESS	49
SETTING UP MOTOR CONTROL PARAMETERS	50
START VOLTAGE	50
MAXIMUM VOLTAGE	50
MID SPEED	50
ACCELERATION	50
DECELERATION	51
MOTOR PWM FREQUENCY	51
NCE TORQUE COMPENSATION KICK RATE	51
NCE TORQUE COMPENSATION KICK DEPTH	51
SET UP DECODER FUNCTION MAPPING	52
SET ANY CV (OPTION 2)	53
REGISTER PROGRAMMING (OPTION 3)	53
PAGED PROGRAMMING (OPTION 4)	54
DIRECT PROGRAMMING (OPTION 5)	54
SET UP NCE LIGHTING EFFECTS (OPTION 6)	54
RECOVERY PROGRAMMING (OPTION 7)	54
DECODER UNLOCK OPTION 8	55
SETUP COMMAND STATION	55
DISPLAY SOFTWARE VERSION AND DATE	55

NUMBER OF STOP PACKETS	55
NUMBER OF TEMP PACKETS	55
NUMBER OF ACCESSORY PACKETS	56
NUMBER OF HORN OFF PACKETS	56
NUMBER OF PROGRAM PACKETS	56
SEND FUNCTION COMMANDS TO CONSIST ADDRESS	56
CONSIST MOMENTUM	56
MOMENTUM MULTIPLIER	56
MOMENTUM DECELERATION RATE	57
FUNCTION REFRESH RATE	57
SYSTEM RESET	57
SET CAB PARAMETERS	57
SHOW TRACK CURRENT	57
NUMBER OF RECALLS	58
ANALOG HORN CHANNEL	58
ANALOG AUX. CHANNEL	58
ANALOG BIAS	58
ASSIGNING THE BELL FUNCTION	58
PROGRAM ACCESSORY DECODERS	59
PROGRAM MACROS	59
LINKING MACROS	60
BROWSE CONSISTS	61
PROGRAM SIGNAL DECODERS	61

PROGRAMMING ON THE MAIN

Programming on the Main is also called Operations (OPS) Mode programming. OPS programming allows you to change parameters while the loco is on the main track (even while it's *running*). This does not affect other locomotives on the track. You can even change the locomotive address.

```
OPS PROG 02:00PM
PROG LOCO: 003
```

We first begin by telling the system which locomotive to program. If you want to program the locomotive you are currently operating just press **ENTER**. If you wish to program a different locomotive just enter its address at the above prompt.

WHAT TO PROGRAM

After determining which locomotive you wish to program you will see the following display. The Power Cab™ system provides 9 different OPs mode programming options.

```
LOC:1022 02:00PM
1=ADR 2=CV 3=CFG
```

The first three options are displayed. Press **ENTER** to see more options. For example: If you wish to set the locomotive address press **1**, if you want to program CVs press **2**.

Descriptions of each programming option are described below.

- 1 SET UP LOCOMOTIVE ADDRESS
- 2 CHANGE ANY CV IN THE DECODER
- 3 SET UP THE DECODER CONFIGURATION (CV29)
- 4 MOTOR CONTROL
- 5 FUNCTION MAP
- 6 NCE EFFECTS
- 7 Not Used
- 8 QSI SOUND
- 9 BIN

ADDRESS PROGRAMMING (Option 1)

This option provides a means by which to program the address of your locomotive. Most decoders allow programming of the locomotive address while on the mainline. The first thing to do is decide if you want to program a long or short address into the locomotive.

```
SET ADDR 03:38PM
1=LONG 2=SHORT
```

In DCC there are 2 kinds of addresses (loco numbers), long and short. Short addresses range from 1 to 127 and long addresses range from 0-9999. We normally recommend using long addresses for all your locomotives. Consists require the use of a short address so it is better to conserve short addresses by using long addresses for individual locomotives. Push the digit button that corresponds to the type of address you wish to program. You will then be presented with the display below.

```
SET ADDR 03:38PM
LONG ADDR: -
```

Enter the new address for the locomotive. The new address will be sent to the locomotive and you will be returned to the normal display with the locomotive selected and ready to run. Most decoders allow programming the address while on the mainline. If you are using a locomotive with a sound decoder from QSI you will need to turn off verbal programming acknowledgment (set CV62 to 0) for the address to be set properly. If your locomotive does not allow setting the address on the mainline you will need to set it on the programming track. You can press **PROG/ESC** to escape out of setting the address without affecting anything in the decoder. No commands are sent until you press **ENTER** after typing in the address.

CV PROGRAMMING FOR MOBILE, LOCOMOTIVE DECODERS (Option 2)

This option allows you to change *any* configuration variable (range of 1-999) in your mobile locomotive decoder.

ENTER CONFIGURATION VARIABLE NUMBER

All configuration variables can be set while on the mainline. Just pressing **ENTER** without typing in a number will return you to the main OPS programming prompt. Pressing **PROG/ESC** will completely exit from programming and return you to the normal display.

```
PROG CV 02:00PM
ENTER CV NUM: _
```

ENTER THE VALUE

The value to be programmed into the CV should now be entered at the prompt below. Pressing **PROG/ESC** before or during number entry will completely exit from programming and return you to the normal display.

```
PROG CV 02:00PM
ENTER VALUE: _
```

SET DECODER CONFIGURATION (Option 3)

This option will setup the various decoder configuration parameters. There are six of these parameters squeezed into one CV. You will be asked a series of questions regarding the basic operation of the locomotive. If you are in doubt about the proper answer just press **ENTER** and you will usually be OK.

DIRECTION BIT - NORMAL OR REVERSE

Press **ENTER** for the locomotive to operate in the normal direction or press **1** to switch the direction of operation.

```
DIR BIT? 02:00PM
ENTER=NORM 1=REV
```

SPEED STEPS - 28 OR 14

Press **ENTER**. All decoders made since 1997 support 28 speeds. NOTE: If you are wondering how to set the decoder for 128 speed operation, you do not have to program anything. 128 speed mode is always enabled in decoders that support 128 speed step operation.

```
SPEED 02:00PM
ENTER=28 1=14 _
```

DC (Analog) MODE

Press **ENTER** to turn DC operation mode off, press **1** to turn DC mode on. We recommend leaving DC mode off for most layouts. This is to prevent all your locomotives from taking off at once in case of a failure in your power station or someone accidentally connecting the track to a DC power supply (it happens more often than you might think).

```
DC MODE 02:00PM
ENTER=NO 1=YES_
```

ADVANCED ACKNOWLEDGE

Press **ENTER** to turn Advanced Acknowledge mode off, press **1** to turn Advanced Acknowledge mode on.

```
ADV ACK? 02:00PM
ENTER=NO 1=YES _
```

NOTE: advanced acknowledgment is not operational in any decoders at this time as the NMRA has not defined how it is to work.

SPEED TABLE SELECTION

If the Standard Speed Table is to be used, press **ENTER**. If the Alternate (uploadable) Speed Table in the decoder is to be used, press **1**.

```
SPEEDTBL 02:00PM
ENTER=STD 1=ALT_
```

ENABLE LONG OR SHORT ADDRESS

The short address is used when operating on DCC systems that do not use long addresses.

```
ADDRESS 02:00PM
ENTER=S 1=LONG:_
```

SET MOTOR CONTROL PARAMETERS (Option 4)

This option can be used to setup the various locomotive motor speed control parameters. You can skip adjusting any of these parameters (CVs) by pressing **ENTER** without entering. The first adjustment is:

START VOLTAGE (CV2)

Start voltage is the amount of voltage the decoder sends to the motor when a speed step 1 command is sent to the locomotive. This is some extra voltage to help get the motor running. You can put in any value from 0-255. If you put in a value of 10 then 10/255 (about 4%) of the full motor voltage will be applied to the motor at speed step 1.

```
OPS PROG 11:22AM
START VOLTS: _
```

In most decoders the start voltage is added to each speed step. A good way to setup the Start Voltage is to first set your throttle to speed 1 then go into this Start Voltage programming and try different values until you get the desired starting speed. This approach can be used with most of the motor speed adjustments. You may exit programming at any time by pressing **PROG/ESC**.

MAXIMUM VOLTAGE (CV5)

This is the amount of voltage applied to the motor at full speed. A value of 255 means send the full available track voltage to the motor. Lower numbers will tell the decoder to send proportionally less voltage when full speed is called for.

```
OPS PROG 11:22AM
MAX VOLTAGE: -
```

A value of 192 will cut the maximum speed to 192/255 (about 75%) of the track voltage. Most decoders interpret a value of 0 to mean 255.

MID SPEED VOLTAGE (CV6)

This is the amount of voltage applied to the motor when the middle speed step (14 or 64 depending on speed mode) is requested. A value of 128 means to send about ½ the available track voltage (128/255 of the voltage) to the motor.

```
OPS PROG 11:22AM
MID VOLTAGE: -
```

Lower or higher values will send proportionally higher or lower voltages at mid-speed. Most decoders interpret a value of 0 to mean 128.

ACCELERATION (CV3)

With this CV set to 0 the decoder will be in what is commonly called 'direct drive'. The decoder will instantly jump to the speed requested by the throttle. You can add momentum by adjusting this parameter. See also MOMENTUM BUTTON, Page 14.

```
OPS PROG 11:22AM
ACCELERATION: -
```

A value of 1 will force a delay of .007 seconds between speed steps in 128 speed mode (.032 seconds in 28 speed mode). This is equivalent to .896 seconds (.007 x 128 speeds) to go from speed 0 to full speed. A value of 10 will yield about 8.9 seconds to full speed.

DECELERATION (CV4)

Deceleration works to delay the slowing down of the motor with the same timing as acceleration.

```
OPS PROG 11:22AM
DECELERATION: -
```

MOTOR PWM FREQUENCY (CV9)

DCC decoders almost always drive the motor of the locomotive with Pulse Width Modulation (PWM). This is a series of full voltage pulses that vary in width from very narrow for low motor speed to very wide providing higher power to the motor. How often the pulses are sent is called the frequency.

```
OPS PROG 11:22AM
PWM FREQ: -
```

The frequency is adjustable on some decoders. Settings for this CV vary so consult your decoder manual for the proper value. If your decoder is capable of 'silent' operation usually a 0 is required.

NCE TORQUE COMPENSATION (Dither) KICK RATE (CV116)

Newer NCE decoders (V3.5+) provide Torque Compensation for smooth low speed operation. Torque Compensation gives a steady stream of 'kicks' to the motor when running at very low speeds. You can adjust how *often* the motor is kicked (Kick Rate) and how *hard* it is kicked (Kick Strength). CV116 controls the rate.

```
OPS PROG 11:22AM
KICK RATE: -
```

The typical value is 2-4 with the maximum practical value of about 6. The smaller the number the more often the motor gets a brief voltage kick. A value of 0 turns off the kick. A value of 1 gives continuous kicks to the motor (not very useful). When using Torque Compensation set the Start Voltage to 0 for best operation.

NCE TORQUE COMPENSATION (Dither) KICK DEPTH (CV117)

This is how hard the motor is kicked at low speed. Typical values range from 1 to 40. High quality motors (Kato) need very little kick strength where lower quality motors such as old Athearn and LifeLike need relatively large values (30-50) for slow speed crawling,

```
OPS PROG 11:22AM
KICK DEPTH: -
```

Tips for setting up T/C (Torque Compensation):

- Start by setting the locomotive speed to 1 on your throttle.
- Set the Kick Rate to 4.
- Set the Kick Depth to 20 then adjust this value up or down until the locomotive just barely crawls.

It may be easier to set the T/C with the body shell removed from the locomotive so that you can see the flywheels turn. When you get fairly good slow speed operation go back to the Kick Rate and try bumping the value up by 1 or 2 to see if the operation improves.

DECODER OUTPUT/FUNCTION MAPPING (Option 5)

General Discussion of function mapping

Function mapping is used to customize which lighting outputs (or sound effects) are controlled by which function keys on your handheld throttle. Each function command, F0 through F12, is assigned a unique CV that allows the corresponding function command to be redirected to up to 14 different lighting outputs or sound effects. A single function key can control more than one output if desired.

It is also possible for one output to be controlled by multiple function keys. In this case, the output will be turned on when any of the corresponding function keys are active. That output will turn off only when all relevant inputs have also been turned off.

Note that all function commands cannot be mapped to all outputs. The LCD display on your Power Cab™ will indicate only those outputs that can be mapped to each function command.

The F0 function has two CVs - one for forward direction and one for reverse. Function outputs mapped to these CVs will be directional unless the same output is mapped to both CVs. CVs 33 and 34 are both for the F0 function.

On NCE decoders CV33 and CV34 do not provide directionality (see SETUP NCE LIGHTING EFFECTS below) but otherwise operate the same as above. With NCE decoders direction of operation for function outputs is provided by the lighting effects CVs 120 through 127.

Lenz and TCS decoders do not follow NMRA standard function mapping procedures. When you select function mapping you are prompted for the function number to map.

```
PRESS FUNCTION
NUMBER TO MAP
```

The top line of the LCD displays the function number and the output numbers that can be controlled by the function.

```
F2      12345678
OUTPUTS: 4
```

Pressing a digit key will enable the output on the decoder when the function is activated. Pressing the same digit key again will disable the output. In the display above the **4** key has been pressed so that output number **4** will activate when ever the **F2** button is pressed on your handheld cab. If you were to press another digit such a **6**, both output **4** and output **6** will be controlled by pressing **F2**.

When mapping functions higher than 3, the top line of the LCD will use small numbers to indicate the output numbers 10 through 14. To enable/disable these high numbers press the digit key that is 10 less than the output number. Example: press **0** for output 10, **1** for output 11, etc. Pressing **PROG/ESC** will exit from mapping at any time.

SETUP NCE LIGHTING EFFECTS (Option 6)

You can use this option to customize the lighting effects for your NCE decoder equipped locomotives. This programming option will only work with NCE decoders.

```
NCE EFX 07:04
OUTPUT NUMBER: _
```

Function outputs are numbered from 1 to 14. Do not confuse *Output* numbers with *Function* numbers. The headlight is always output 1 and the reverse light is usually output 2. You are prompted for the output number to setup. Press the output number followed by **ENTER**.

```
OUTPUT NUMBER:03
USE THUMBWHEEL
```

Use the thumbwheel or up/down speed buttons to scroll through the different lighting effect options. Press **ENTER** when you get the one you want.

```
DIR OF OPERATION
1=FW 2=RV 3=BOTH
```

Next press **1,2** or **3** to select the 'directionality' of the output. If you want the output active only in the forward direction of travel - press **1**. Press **2** for the effect to operate only when travelling in reverse. **3** activates the output no matter which direction the locomotive is travelling.

```
REGULAR BULB OR  
LED 1=BULB 2=LED
```

Last, press **1** if the output has a regular incandescent bulb attached. Press **2** if the output has an LED connected. LEDs behave differently when dimmed than incandescent bulbs. Pressing **1** or **2** informs the decoder which set of lighting characteristics to use for this output.

QSI PROGRAMMING (Option 8)

QSI sound decoders use indexed programming of CV51, CV52, and CV56. You are asked for an index number before you are asked for the CV value. CV49 is then automatically set with the index value before the original CV is set with the desired data.

When programming CV56 you are asked for primary and secondary index numbers before you are asked for the CV value. CV49 and CV50 are then automatically set with the index numbers before CV53 is set with the desired data.

All other CV's are programmed in the normal manner.

BINARY CV PROGRAMMING (Option 9)

Use this option if you need to build up the value for a CV bit-by-bit. Enter the CV number you wish to program.

```
BIN PROG 02:10AM  
ENTER CV NUM: _
```

Then press bit number (top line of LCD has bit numbers) to toggle the corresponding individual bits on the lower line of the LCD that make up a binary byte. In the example below the **1**, **3** and **7** keys have been pressed to set the corresponding bits in the byte. To set the value of a bit back to 0 press the bit number again.

```
CV: 060 76543210  
BITS: 10001010
```

When you get the value built up to the number you desire, press **ENTER** to program the CV.

ASSIGNING A LOCO TO A CAB (shortcut = PROG 2)

This selection passes a loco or consist from one cab to another. This is especially useful when the other operator is a novice or has a Basic Cab. The locomotive/consist is passed to the assigned cab and the locomotive/consist controlled by the other cab is passed back to the original cab. In effect the locomotives controlled by the cabs are "swapped". This way you will not accidentally 'lose' a locomotive in the system.

ASSIGN THE LOCO

Enter the loco/consist number you want to assign to another cab, then press **ENTER**. If you want to assign the loco you are currently running just push **ENTER**.

```
ASSIGN 02:00PM  
WHICH LOCO: _003
```

ASSIGN THE CAB

You need to know the address of the cab you want to 'receive' the loco you are assigning. Enter the Cab number then press **ENTER**.

```
LOC:1234 02:00PM  
TO WHICH CAB? _
```

This operation is also useful to transfer an old style consist to a smaller cab without the capability of setting up consists.

SET THE SYSTEM CLOCK (shortcut = PROG 3)

This allows the operator to start/stop the clock, set it, choose 12 or 24 hour operation, or change the fast clock ratio.

STOPPING THE CLOCK

Press **1** to stop the clock, press **ENTER** to leave the clock running and continue with clock programming. If the clock is already stopped, you will be prompted to start it.

```
STOP? 02:00PM  
ENTER=NO 1=STOP
```

SETTING 12 or 24 HOUR MODE

Press **1** for 12 hour mode, press **ENTER** for 24 hour mode.

```
SET TIME 02:00PM  
1=12HR 2=24HR _
```

ENTERING THE HOUR

Enter the starting hour in 24 hour format. For times in the A.M. use 0 to 11. For times in the P.M. use 12 to 23. Press **ENTER**.

```
SET TIME 02:00PM
ENTER HOURS:  _
```

ENTERING THE MINUTE

Enter the starting minute. Use 0 through 59. Press **ENTER**.

```
SET TIME 02:00PM
ENTER MINUTES:  _
```

ENTERING THE RATIO

Enter the ratio that the clock should run at with 1 being the normal speed. The ratio can be any number from 1 (1:1) to 15 (15:1). Press **ENTER**.

```
SET TIME 02:00PM
ENTER RATIO:  _
```

STARTING THE CLOCK

If the clock was stopped, entering SET THE SYSTEM CLOCK will display this screen to let you start (or restart) the clock. Press **1** to start the clock, press **ENTER** to leave the clock stopped and continue with clock programming (see above).

```
START?      02:00PM
ENTER=NO    1=START
```

USE PROGRAM TRACK

(shortcut = PROG 4)

Locomotive decoders remember their operating parameters such as the address, start voltage and lighting effect setups in the decoder's memory. Each storage location is called a Configuration Variable, or CV for short. There is usually a CV for each programmable parameter. The Power Cab™ allows you to change any or all of the CVs in the loco, including the address. These variables will remain as programmed until you change them. Programming on the Main (covered earlier in this manual) is very useful for modifying one, two or a few CVs while the locomotive is out on the layout. The Program Track is useful for more intensive initial setup of a locomotive. The biggest advantage of the program track is the ability to read out the values of CVs already setup in the locomotive decoder.

Please note: The programming track does not supply enough power to run your locomotive. You can only run trains on the main track. We recommend that you always try out a newly installed decoder on the Program Track first. If you can 'read' a decoder on the Program Track you can reasonably expect that it is wired correctly and working properly.

PROGRAMMING OPTIONS

Just as with Programming on the Main there are several menu options you can select. The Power Cab™ system provides 7 different Program Track options. Descriptions of each programming option are described below.

- 1 = STANDARD DECODER SETUP, including
Address, Configuration and Function Mapping.
- 2 = CHANGE ANY CV IN THE DECODER
Reads and programs CVs 1-999.
- 3 = SET UP THE DECODER CONFIGURATION (CV29)
Change direction of operation, analog mode on/off, 14 or 28 speed mode,
long or short address, factory or custom speed table.
- 4 = PAGED MODE PROGRAMMING
Force the system to use paged mode programming.
- 5 = DIRECT MODE PROGRAMMING
Force the system to use direct mode programming.
- 6 = NCE EFFECTS
Setup NCE lighting effects.
- 7 = RECOVERY PROGRAMMING
Reprograms selected decoder CVs in an attempt to get an 'insane' decoder
back to somewhat normal operation.
- 8 = DECODER UNLOCK
Unlocks a "Lockable, NCE decoder.

The first three options are displayed below. Press **ENTER** to see more options. For example: If you wish to program the "Standard" locomotive parameters, press 1, if you want to program decoder CVs press 2.

```
PROG TRK 02:00PM
1=STD 2=CV 3=REG
```

This screen allows the user to select the method of programming to suit the decoder

you are using. There are 7 programming options when using the program track. STD programming (option 1) will automatically determine whether to use the Direct or Paged programming methods. Paged programming is used by older decoders and can take up to fifteen seconds to read each CV. Direct mode is newer and generally reads CVs in one to two seconds. For various reasons you may wish to 'force' the programming method to one or the other types. You can press **4** for paged programming or press **5** for direct programming. Standard (1) sets the most common decoder parameters.

STANDARD PROGRAMMING (Option 1)

This option automatically determines if the decoder supports Direct or Paged programming and uses the appropriate method for subsequent programming operations. Use this option for initial setup of your decoder. You will be advised about the manufacturer and the version of the decoder software. You will also be able to setup the decoder address, basic configuration, motor control, NMRA standard function mapping and finally any additional CVs you may wish to program.

DECODER MANUFACTURER

This is the NMRA assigned manufacturer number of the decoder. All NCE decoders respond with 11. Press **ENTER** to continue.

```
MAIN OFF 02:00PM
MANUFACTURER:011
```

You may get this error message:

```
MAIN OFF 02:00PM
CAN NOT READ CV
```

This means the decoder did not respond to attempts to read this parameter value in the decoder. There are several things that can cause a failure to read: a miswired decoder, broken or missing track pickup wires, **the motor is not connected to the decoder**, defective decoder, wires to the program track are disconnected, etc. You may also see this error if the CV you are reading is not supported by the decoder. All decoders require that a motor (or similar 'load') be connected to the decoder for proper reading on the program track. Decoders that draw too much power from the program track can also cause this message. Most sound decoders draw large amounts of current. The Power Cab™ can supply the NMRA limit of ¼ Amp of current for initial 'charging' of these decoders and 220mA of continuous current for normal program track operations. If the decoder exceeds these capabilities you will get the error or a short circuit message. Press **ENTER** to continue. You will probably still be able to program by ignoring the error. Press **ENTER**, then proceed in the usual manner.

DECODER VERSION

This display indicates the programming method in use on the top line and the version number of the software in the decoder on the bottom line. Press **ENTER** to continue.

```
DIR MODE 02:00PM
DECODER VER: 041
```

DISPLAY OF ACTIVE ADDRESS

The current active address (long or short) is indicated on the top line of the display. If you wish to change the decoder address press 1. Any other button will skip programming the address and continue standard programming.

```
ACTIVE ADR: SHORT
SETUP ADDR 1=YES
```

ENTERING THE DECODER (LOCOMOTIVE) ADDRESS

The short address is displayed first. If you wish to change it type in the new address and press **ENTER**. If you wish to keep it unmodified just press **ENTER** to skip to the display of the long address.

```
ACTIVE ADR: SHORT
SHORT ADDR: 003
```

If you put in a new address you will see the following LCD screen asking if you wish to make this address the primary address. Only one address can be the primary address – the long or the short. You cannot have both active at the same time. The decoder will not allow it.

The long address is displayed next. If you wish to change it type in the new address and press **ENTER**. If you wish to keep it unmodified just press **ENTER** to continue programming.

```
SETUP ADDRESS
LONG ADDR: 1044
```

If you enter a new long address you will be asked if you want to activate it. Press 1 for yes. Any other key continues with programming.

```
ACTIVATE
THIS ADDR: 1=YES
```

NOTES ON ADDRESSES:

The short address is available for use on layouts using short addresses. If the short address is to be the primary address you should use the last two digits of the loco number. Short addresses range from 1 to 127.

For the long address, any number from 0 through 9999 can be used. You need to distinguish long addresses from short when assigning an address below 128 by entering a zero as the first character.

Example: short address = 64

long address (below 128) = 064

We recommend that if a long address is used, leave the short address at 3. This has two advantages. One, if the long address is forgotten, the short address is always 3. Two, advanced consist addresses share the same 1 to 127 address range available to the short addresses. Using the same address for an Advanced Consist and another existing loco will cause unpredictable results.

SETTING UP BASIC DECODER CONFIGURATION (CV29)

This option will setup various decoder configuration parameters. There are six of these parameters squeezed into one CV. Press 1 if you want to set these parameters. Any other key will skip to Motor Control Setup.

```
SET CFG?  
ENTER=NO 1=YES
```

You will be asked a series of questions regarding the basic operation of the locomotive. If you are in doubt about the proper answer just press **ENTER** and you will usually be OK.

DIRECTION BIT - NORMAL OR REVERSE

Press **ENTER** for the locomotive to operate in the normal direction or press **1** to switch the direction of operation.

```
DIR BIT? 02:00PM  
ENTER=NORM 1=REV
```

SPEED STEPS - 28 OR 14

If the decoder in this locomotive is an early 14 step decoder then press **1**. (all decoders made since 1997 support 28 speeds). NOTE: If you are wondering how to set the decoder for 128 speed operation, you do not have to program anything. 128 speed mode is always enabled in decoders that support 128 speed step operation.

```
SPEED 02:00PM  
ENTER=28 1=14 _
```

DC (Analog) MODE

Press **ENTER** to turn DC operation mode off, press **1** to turn DC mode on. We recommend leaving DC mode off for most layouts.

```
DC MODE 02:00PM  
ENTER=NO 1=YES _
```

This is to prevent all your locomotives from taking off at once in case of a failure in your power booster or someone accidentally connecting the track to a DC power supply (it happens more often than you might think).

ADVANCED ACKNOWLEDGE

Press **ENTER** to turn Advanced Acknowledge mode off, press **1** to turn Advanced Acknowledge mode on.

```
ADV ACK? 02:00PM  
ENTER=NO 1=YES _
```

NOTE: advanced acknowledgment is not operational in any decoders at this time as the NMRA has not defined how it is to work.

SPEED TABLE SELECTION

If the Standard Speed Table is to be used, press **ENTER**. If an Alternate (uploadable) Speed Table in the decoder is to be used, press **1**.

```
SPEEDTBL 02:00PM  
ENTER=STD 1=ALT_
```

ENABLE LONG OR SHORT ADDRESS

The short address is used when operating on DCC systems that do not use long address.

```
ADDRESS 02:00PM
ENTER=S 1=LONG:_
```

SETTING UP MOTOR CONTROL PARAMETERS

This option can be used to setup the various locomotive motor speed control parameters. You can skip adjusting any of these parameters (CVs) by pressing **ENTER**. Press **1** to adjust motor control.

```
SET UP MOTOR
CONTROL? 1=YES
```

The first adjustment is:

START VOLTAGE (CV2)

Start voltage is the amount of voltage the decoder sends to the motor when a speed step 1 command is sent to the locomotive. This is some extra voltage to help get the motor running. You can put in any value from 0-255. If you put in a value of 10 then 10/255 (about 4%) of the full motor voltage will be applied to the motor at speed step 1. In most decoders the start voltage is added to each speed step.

```
OPS PROG 11:22AM
START VOLTS: _
```

A good way to setup the Start Voltage is to first set your throttle to speed 1 then go into this Start Voltage programming and try different values until you get the desired starting speed. This approach can be used with most of the motor speed adjustments. You may exit programming at any time by pressing **PROG/ESC**.

MAXIMUM VOLTAGE (CV5)

This is the amount of voltage applied to the motor at full speed. A value of 255 means send the full available track voltage to the motor. Lower numbers will tell the decoder to send proportionally less voltage when full speed is called for.

```
OPS PROG 11:22AM
MAX VOLTAGE: _
```

A value of 192 will cut the maximum speed to 192/255 (about 75%) of the track voltage. Most decoders interpret a value of 0 to mean 255.

MID SPEED VOLTAGE (CV6)

This is the amount of voltage applied to the motor when the middle speed step (14 or 64 depending on speed mode) is requested. A value of 128 means to send about ½ the available track voltage (128/255 of the voltage) to the motor.

```
OPS PROG 11:22AM
MID VOLTAGE: _
```

Lower or higher values will send proportionally higher or lower voltages at mid-speed. Most decoders interpret a value of 0 to mean 128.

ACCELERATION (CV3)

With this CV set to 0 the decoder will be in what is commonly called 'direct drive'. The decoder will instantly jump to the speed requested by the throttle. You can add momentum by adjusting this parameter.

```
OPS PROG 11:22AM
ACCELERATION: -
```

A value of 1 will force a delay of .007 seconds between speed steps in 128 speed mode (.032 seconds in 28 speed mode). This is equivalent to .896 seconds (.007 x 128 speeds) to go from speed 0 to full speed. A value of 10 will yield about 8.9 seconds to full speed.

DECELERATION (CV4)

Deceleration works to delay the slowing down of the motor with the same timing as acceleration.

```
OPS PROG 11:22AM
DECELERATION: -
```

MOTOR PWM FREQUENCY (CV9)

DCC decoders almost always drive the motor of the locomotive with Pulse Width Modulation (PWM). This is a series of full voltage pulses that vary in width from very narrow for low motor speed to very wide providing higher power to the motor.

```
OPS PROG 11:22AM
PWM FREQ: -
```

How often the pulses are sent is called the frequency. The frequency is adjustable on some decoders. Settings for this CV vary so consult your decoder manual for the proper value. If your decoder is capable of 'silent' operation usually a 0 is required.

NCE TORQUE COMPENSATION (Dither) KICK RATE (CV116)

If your decoder supports NCE torque compensation this menu item will be displayed. If not you will be sent to SET UP FUNCTION MAPPING.

NCE decoders since version 3.5 provide Torque Compensation for smooth low speed operation. Torque Compensation gives a steady stream of 'kicks' to the motor when running at very low speeds. You can adjust how *often* the motor is kicked (Kick Rate) and how *hard* it is kicked (Kick Strength).

```
OPS PROG 11:22AM
KICK RATE: -
```

CV116 controls the rate. The typical value is 2-4 with the maximum practical value of about 6. The smaller the number the more often the motor gets a brief voltage kick. A value of 0 turns off the kick. A value of 1 gives continuous kicks to the motor (not very useful). When using Torque Compensation set the Start Voltage to 0 for best operation.

NCE TORQUE COMPENSATION (Dither) KICK DEPTH (CV117)

This is how hard the motor is kicked at low speed. Typical values range from 1 to 40. High quality motors (Kato) need very little kick strength where lower quality motors such as old Athearn and LifeLike need relatively large values (30-50) for slow speed crawling,

OPS PROG 11:22AM
KICK DEPTH: -

Tips for setting up T/C (Torque Compensation):

- Start by setting the locomotive speed to 1 on your throttle.
- Adjust the Kick Rate to 4.
- Set the Kick Depth to 20 then adjust this value up or down until the locomotive just barely crawls.

It may be easier to set the T/C with the body shell removed from the locomotive so that you can see the flywheels turn. When you get fairly good slow speed operation go back to the Kick Rate and try bumping the value up by 1 or 2 to see if the operation improves.

SETUP DECODER OUTPUT/FUNCTION MAPPING

General Discussion of function mapping

Function mapping is used to customize which decoder lighting outputs (or sound effects) are controlled by which function keys on your handheld throttle. Each function command, F0 through F12, is assigned a unique CV that allows the corresponding function command to be redirected to up to 14 different lighting outputs or sound effects. A single function key can control more than one output if desired. It is also possible for one output to be controlled by multiple function keys. In this case, the output will be turned on when any of the corresponding function keys are active. That output will turn off only when all relevant inputs have also been turned off.

Note that all function commands cannot be mapped to all outputs. The LCD display on your Power Cab™ will indicate only those outputs that can be mapped to each function command.

The F0 function has two CVs - one for forward direction and one for reverse.

Function outputs mapped to these CVs will be directional unless the same output is mapped to both CVs. CVs 33 and 34 are both for the F0 function. On NCE decoders CV33 and CV34 do not provide directionality (see SETUP NCE LIGHTING EFFECTS on page 53) but otherwise operate the same as above. With NCE decoders direction of operation for function outputs is provided by the lighting effects CVs (120 through 127). Lenz and TCS decoders do not follow NMRA standard function mapping procedures.

When you select function mapping you are prompted for the function number to map.

PRESS FUNCTION
NUMBER TO MAP

The top line of the LCD displays the function number and the output numbers that can be controlled by the function. The lower line displays the currently controlled outputs.

Pressing a digit key will enable the output on the decoder when the function is activated. Pressing the same digit key again will disable the output. In the display below, the 4 key has been pressed so that output number 4 will activate when ever the F2 button is pressed on your handheld cab. If you were to press another digit such a 6, both output 4 and output 6 will be controlled by pressing F2.

F2 12345678
OUTPUTS: ---4---

When mapping functions higher than 3, the top line of the LCD will use small numbers to indicate the output numbers 10 through 14. To enable/disable these high numbers

press the digit key that is 10 less than the output number. Example: press 0 for output 10, 1 for output 11, etc.

Pressing **PROG/ESC** will exit from mapping at any time.

SET ANY CV (Option 2)

This option allows you to change *any* configuration variable (range of 1-999) in your decoder. Press **PROG/ESC** at any time to exit.

```
PROG CV 02:00PM
ENTER CV NUM: _
```

ENTER CONFIGURATION VARIABLE NUMBER

All configuration variables can be set while on the Program Track. Just pressing **ENTER** without typing in a number will return you to the main OPS programming prompt. Pressing **PROG/ESC** will completely exit from programming and return you to the normal display.

ENTER THE VALUE

The value to be programmed into the CV should be entered at the prompt below. Pressing **PROG/ESC** before or during number entry will completely exit from programming and return you to the normal display.

```
PROG CV 02:00PM
ENTER VALUE: _
```

REGISTER PROGRAMMING (Option 3)

The programming section is included to make setting of MRC and old Lenz Decoders possible. Refer to the document that is included with the Decoder for register information.

ENTER THE REGISTER TO PROGRAM

Enter the register number and press **ENTER**. The current value of that register will be read from the Decoder and displayed. If you wish to modify the value type in a new number and press **ENTER**.

```
PROG TRK
REGISTER? _
```

If you want to keep the value just press **ENTER** without putting in any numbers.
Registers used with decoders that require register programming

CV #	Description	Register #
1	Short Address (0-99 valid)	1
2	Start Voltage (0-15 valid)	2
3	Acceleration (0-15 valid)	3
4	Deceleration (0-15 valid)	4
29	Configuration byte (set to 6)	5

PAGED PROGRAMMING (Option 4)

Option 4 forces the system to use Paged mode while doing Standard and all subsequent programming. Almost all decoders support Paged Mode.

DIRECT PROGRAMMING (Option 5)

Option 5 forces the system to use Direct mode while doing Standard and all subsequent programming. Older decoders (built prior to 1/1/2001) do not support Direct Mode programming.

SETUP NCE LIGHTING EFFECTS (Option 6)

You can use this option to customize the lighting effects for your NCE decoder equipped locomotives. This programming option will only work with NCE decoders.

```
NCE EFX 07:04AM
OUTPUT NUMBER:
```

Function outputs are numbered from 1 to 14. Do not confuse *Output* numbers with *Function* numbers. The headlight is always output 1 and the reverse light is usually output 2. You are prompted for the output number to setup. Press the output number followed by **ENTER**.

Use the thumbwheel or up/down speed buttons to scroll through the different lighting effect options. Press **ENTER** when you get the one you want.

```
OUTPUT NUMBER:03
USE THUMBWHEEL
```

Next press 1,2 or 3 to select the 'directionality' of the output. If you want the output active only in the forward direction of travel - press 1. Press 2 for the effect to operate only when travelling in reverse. 3 activates the output no matter which direction the locomotive is travelling.

```
DIR OF OPERATION
1=FW 2=RV 3=BOTH
```

Last, press 1 if the output has a regular incandescent bulb attached. Press 2 if the output has an LED connected. LEDs behave differently when dimmed than incandescent bulbs. Pressing 1 or 2 informs the decoder which set of lighting characteristics to use for this output.

```
REGULAR BULB OR
LED 1=BULB 2=LED
```

RECOVERY PROGRAMMING (Option 7)

This programming section is included to allow the user to set *all* registers of the Decoder to the values that were programmed into it at the factory.

```
RECOVERY
PROGRAM 1=YES
```

Press **1** to enter Recovery mode. This will reprogram NCE decoders (and most others) to their original factory values. It will also set addresses, motor control CVs and Function Mapping CVs to a useful state so that you can get control of a decoder. As each CV is programmed the CV number is displayed.

DECODER UNLOCK (Option 8)

This programming section is included to allow the user to unlock a decoder that has been locked (CV 15, 16) and you do not remember the locking value.

```
PROG TRK 0:00
UNLOCK? 1=YES
```

Press **1** to automatically unlock the decoder. The display will cycle through all possible values of CV 15. This may take up to 5 minutes.

```
PROG TRK 0:00
TESTING CV15=XX
```

SETUP COMMAND STATION (Shortcut = PROG 5)

This allows the operator to view the Power Cab's version number and set various system (not decoder) parameters.

DISPLAY SOFTWARE VERSION AND DATE

This screen is important when the time comes to call or write about a question or a problem.

```
NCE      01:30AM
POWER CAB V1.28
```

The following screens are available should a need arise to change any of the factory settings. There is probably no reason to ever change these settings. If you get things REALLY messed up you can reset the system to original factory settings (see paragraph above).

NUMBER OF STOP PACKETS (default is 8)

This adjusts how many times a stop command is sent to the Loco. If you have a large layout or run more than about 40 different locomotives in a session we recommend setting this to 8. This will automatically purge non-necessary speed 0 commands from being sent to the track increasing system response to throttle commands.

```
NUMBER      02:00PM
OF STOP PKTS 008
```

If set to zero all speed 0 commands will continue to be circulated for every locomotive that has been controlled (but now is stopped) since the system was last turned on. Factory default is 8. Press **ENTER** to skip setting this parameter.

NUMBER OF TEMP PACKETS (default is 4)

This adjusts the number of Function control commands that are sent when a Function control button is pressed. Factory default is 5. Press **ENTER** to skip setting this parameter.

```
NUMBER      02:00PM
OF TEMP PKTS 004
```

NUMBER OF ACCESSORY PACKETS (default is 4)

This adjusts the number of accessory control commands sent when an accessory or signal is controlled. Factory default is 4. Press **ENTER** to skip setting this parameter.

```
NUMBER    02:00PM  
OF ACC PKTS: 004
```

NUMBER OF HORN OFF PACKETS (default is 2)

This adjusts the number of times a "horn off" packet is sent when the **HORN** button is released. The factory default is 2 but can be set as high as 16. Press **ENTER** to skip setting this parameter.

```
NUMBER    02:00PM  
HORN OFF PKT 002
```

NUMBER OF PROGRAM PACKETS (default is 4)

This adjusts the number of times a programming command is sent when programming a locomotive on the mainline. Factory default is 4. Press **ENTER** to skip setting this parameter.

```
NUMBER    02:00PM  
OF PROG PKTS 004
```

SEND FUNCTION COMMANDS TO CONSIST ADDRESS (default is 1=Y)

Function commands are normally sent to the lead loco of an advanced consist. They can also be sent to the consist address so that other locomotives in consist can react to these commands if desired. The factory default is yes. Press **ENTER** to skip setting this parameter.

```
SEND FUNCTION TO  
CON?      1=Y 0=N 1
```

CONSIST MOMENTUM (default is 1=Y)

You can disable the momentum button on all handheld cabs that are operating a consist. The buttons are enabled by factory default. Press **ENTER** to skip setting this parameter.

```
CONSIST MOMENTUM  
ENABLE 1=Y 0=N 1
```

MOMENTUM MULTIPLIER (default is 8)

When you press the **MOMENTUM** button you are prompted for a single digit indicating how much momentum you want for the loco/consist you are controlling. Momentum CVs have a range of 0-255 while the button asks for values from 0-9.

```
MOMENTUM BUTTON  
MULTIPLIER: 08
```

The value you enter for the momentum button is multiplied by this parameter (factory default of 8) and sent to CV3 in the locomotive. This parameter adjusts the

multiplication factor. You can set it from 0-25. Press **ENTER** to skip setting this parameter.

MOMENTUM DECELERATION RATE (default is 0=HALF)

The deceleration rate (CV4) when pressing the momentum button can be either half the value sent for acceleration (CV3) or the full value sent to CV3. Factory default is ½. Press **ENTER** to skip setting this parameter.

```
MOMEN DECEL RATE
1=FULL 0=HALF 0
```

FUNCTION REFRESH (default is 0=OFF)

Function Refresh will keep the lights and sounds working (F0 through F8) on locomotives that don't remember the state of their functions on start up and dirty track. The Function Refresh rate is set to occur about once per second. If all functions are OFF or the locomotive speed is Zero (0), the functions for that locomotive will not be refreshed.

```
FUNCTION REFRESH
ENABLE 1=Y 0=N
```

RESET SYSTEM?

Reset System will reset all of the system configuration settings to their factory defaults. Only the Power Cab memory will be reset, the memory as a Pro Cab will remain.

```
RESET SYSTEM?
PRESS 6 FOR YES
```

Press 6 to enter the Reset action.

```
ARE YOU SURE?
PRESS 1 FOR YES
```

The system will reset itself and take you back to the opening screen.

SET UP THE CAB PARAMETERS

(Shortcut = PROG 6)

SHOW TRACK CURRENT:

```
SHOW 02:00PM
TRK CURRENT? 1=Y
```

Press **1** to enable the display of current being supplied to the main running track by the system when in normal operations mode. Current display will be cancelled by programming on the main, using the program track, or cycling the system power.

NUMBER OF RECALLS

This adjusts the number of recall "slots" that are cycled through when the **RECALL** key is pressed. Enter a number of Recalls from 1 - 6 and press **ENTER**. This can be set differently for each Cab. (factory default is 2) Press **ENTER** to skip setting this parameter.

```
NUMBER 02:00PM
OF RECALLS: 02
```

ANALOG HORN CHANNEL (default is 0)

```
ANALOG 02:00PM
HORN CHANNEL -
```

If you have a decoder that supports a "playable" whistle such as a SoundTraxx Tsunami, enter the analog "channel number" that the decoder uses for whistle. You can play the whistle by holding the HORN/WHISTLE button while moving the thumbnwheel. If the channel is set to 0 no analog commands will be sent.

ANALOG AUX CHANNEL (default is 0)

```
ANALOG 02:00PM
AUX CHANNEL: -
```

ANALOG BIAS (default is 0)

```
ANALOG 02:00PM
BIAS (0-15) -
```

This is the starting point or "level" (0-15) at which analog commands will start.

ASSIGNING THE BELL FUNCTION (default is 1)

Enter the function number that should be activated when the Bell key is pressed. We recommend using 1, however any function number may be used. Soundtraxx **Diesel** decoders use Function #1 for control of the Bell.

```
ASSIGN 02:00PM
BELL TO FUNC: 1
```

Older Soundtraxx **Steam** decoders use Function #3 for the Bell. The steam decoders can have the bell "re-mapped" to Function #1 (Diesel decoders can not re-map the bell to Function #3). Press **ENTER** to skip setting this parameter.

PROGRAM ACCESSORY DECODERS (Shortcut = PROG 7)

This allows the operator to set Accessory Decoder CVs while they are connected to the Track (Accessory Programming on the Main).

ENTER THE ACCESSORY ADDRESS

Enter the Accessory Decoder address and press **ENTER**.

```
PROG ACC 02:00PM
ACC. ADDR: _
```

ENTER THE CV NUMBER

Enter the CV number that you want to program and press **ENTER**.

```
PROG ACC 02:00PM
ENTER CV NUM: _
```

ENTER THE CV VALUE

Enter the value you want in the CV and press **ENTER**.

```
PROG ACC 02:00PM
ENTER VALUE: _
```

For Compatibility, both "legacy" and new style programming commands are issued to Accessory Decoders.

PROGRAM MACROS (Shortcut = PROG 8)

This allows the operator to program Macros (switch lists).

SELECT MACRO PROGRAM OR REVIEW

Press **1** to program a Macro or press **2** to review a programmed Macro.

```
MACRO: 02:00PM
1=PROG 2=REVIEW
```

If **1** is pressed the following screen is displayed.

```
MACRO: 02:00PM
MACRO NUMBER: _
```

ENTER THE MACRO NUMBER

Enter the Macro number that you want to program (0-15), and press **ENTER**.

ENTER THE ACCESSORY ADDRESS LINKING MACROS

Enter the Accessory Address that you want to control, and press **ENTER**. A macro can be linked to another macro by entering an accessory address of 9999 at this point. You will be prompted for the macro number to link.

```
MAC: 000 02:00PM
ACCESSORY #: _
```

You can chain as many macros together as you like but use caution. If you chain macros in a 'circular' fashion the system will appear to crash (it is busy sending macros continuously) until you press PROG/ESC on the cab that issued the macro. If a computer is used the only solution is to cycle the power to the system and fix the circular reference.

SELECT THE TURNOUT POSITION

Press **1** for Normal or **2** for Route.

```
MAC: 000 02:00PM
ACC: 001 1=N 2=R
```

The above two screens will repeat up to 8 times to allow you to enter up to 8 accessories. After 8 accessories have been entered the SELECT MACRO PROGRAM OR REVIEW screen will be displayed. If you want to enter less than 8 accessories, leave the accessory # blank (just press **ENTER**). If **2** is pressed on the SELECT MACRO PROGRAM OR REVIEW screen, the following screen is displayed.

ENTER THE MACRO NUMBER TO BE REVIEWED

Enter the Macro number that you want to review (0-15), and press **ENTER**.

```
REVIEW: 02:00PM
MACRO NUMBER: _
```

REVIEW MACRO

The Accessory number and output will be shown. Press **ENTER** to see the next Accessory in the Macro. If there are no more Accessories in the Macro, the following screen will be displayed.

```
MAC: 000 02:00PM
ACCESSORY: 001=N
```

REVIEW END OF MACRO

After **ENTER** is pressed, the SELECT MACRO PROGRAM OR REVIEW screen will be displayed.

```
MACRO: 02:00PM
END OF MACRO
```

BROWSE CONSISTS (Shortcut = PROG 9)

This option lets you see what advanced consists are currently in the memory of the system.

Press **ENTER** at the "BROWSE CONSISTS" prompt. The LCD will display the highest numbered consist in the system memory. It will look something like:

```
CON: 127 10:42AM  
LEAD:2190 R:4484
```

Use the speed buttons or thumbwheel to scroll the next higher or lower consist in the list. When you get to the end of the list it will roll over to the 'other' end. Pressing **ENTER** will show any mid consist locomotives of the displayed consist.

Pressing **ENTER** while the Lead/Rear locomotives are displayed will show any mid-consist locomotives. (The system will remember up to 2 mid-consist locos per advanced consist). Press **ENTER** again to view the next consist.

Pressing **SEL LOCO** will exit browsing and select the displayed consist for running.

Pressing **CLEAR** then pressing 1 at the "KILL CON?" prompt will kill the displayed consist.

Press **PROG/ESC** at any time to exit browsing.

PROGRAM SIGNAL DECODERS (Shortcut = PROG 0)

This allows the operator to setup Signal Decoders while they are connected to the Track (Signal Programming on the Main).

ENTER THE SIGNAL ADDRESS

Enter the Decoder address and press **ENTER**.

```
PROG ACC 02:00PM  
SIGNAL NUM: -
```

ENTER THE CV NUMBER

Enter the CV number that you want to program and press **ENTER**.

```
PROG ACC 02:00PM  
ENTER CV NUM: -
```

ENTER THE CV VALUE

Enter the value you want in the CV and press **ENTER**.

```
PROG ACC 02:00PM  
ENTER VALUE: -
```

HELPFUL HINTS FOR OPERATION

- Passing an old style consist: Use **ASSIGN LOCO TO CAB** to transfer an old style consist to any other Cab on the system. This causes a *swap* between the active loco/consist on your Cab and the active loco/consist on the target Cab.
- Nesting consists: Say a heavy freight is approaching a long grade and helpers are needed. The train's locomotives are an advanced consist. The two GP9 pushers are also consisted using an advanced consist. The pusher consist is brought out of the siding at the base of the grade and put in place. An "old style" consist is now set up using the freight's lead loco number and the pusher's lead loco number. You can now operate the entire train to the grade crest as one unit. Upon reaching the cutoff siding at the crest, the "old style" consist is killed and the pushers are selected to move to the siding. The freight consist continues on while the pushers drift back down the hill.
- When setting up an old style Consist, you may want to use a Loco number that does not exist for the first Loco (Consist address). This will allow you to put the actual lead loco in recall to operate the headlight, and the sound loco to operate the Horn and Bell.
- If a cab does not respond after plugging it in, press the **ENTER** key a couple of times. This will cause it to exit from any mode it was in when it was unplugged.
- When making your own cables using RJ plugs be SURE the connectors are "flipped" over at opposite ends of the wire. See the illustration on page 21 for proper cab bus cabling.

Using the Power Cab/ProCab

- In DCC there are 2 kinds of addresses (loco numbers), long and short. When entering the address of the loco you wish to control long addresses from 1 to 127 are entered by preceding the actual number by a zero. Short addresses are entered without a leading zero. Long addresses in the range of 1 -127 are displayed on your cab with an asterisk before the loco number. ie: *"*042"* indicates the long address for loco forty-two and *"042"* indicates the short address. Most modern decoders made since 1997 support long (4 digit) addresses. Older Lenz, Digitrax and MRC decoders only support the short address.
- When entering numbers if you make a mistake there is no "erase" or "backup" key. If you keep pressing digits the display will clear allowing you to start entering your number over again.
- If you wish to abandon what you are doing when in the middle of entering a number push the "PROG/ESC" key and you will be returned to normal operation.
- During various operations where you are doing something other than normal loco operation such as "set up consist" or "select accessory" speed control of the loco is not available, however the Emergency Stop will still work if you need to stop your loco.
- Programming on the programming track the command station first reads the value of a location (such as "short address" or "acceleration") and displays it on your cab. If you wish to accept this value just press ENTER to continue or type in a new number if you want to change it.

Programming Track

- The command station checks for a short circuit on the programming track before applying power. If your loco has lights or other current drawing devices wired directly to the track instead of a decoder function output the command station will probably think it has a short and will say "SHORT DETECTED" each time you start to program this loco. If you wish you will be allowed to override the short and continue. This short detection is there to protect decoders from damage if they are miswired. For this reason we always try a new decoder installation on the programming track first instead of putting it directly on the layout. If the programming works the installation is most likely correct.

TROUBLE SHOOTING

- Locomotive was running yesterday but today it just sits there - The headlight and other functions are controllable but it won't run. - This sometimes happens when you clear a consist but for some reason the decoder misses the command. Use the **DEL LOCO** button to "re-delete" the locomotive. Alternatively use programming on the main to set CV19 to 0 (same thing as clearing the consist).
- Head Light goes on and off as I change speed - You are operating a loco with an older 14 step decoder in the 28 step mode and the head light is ON only in the even speed steps.
- The programmability of the decoders gives the modeler a *lot* of flexibility. However, this can lead to some unpredictable results. Here are a few tips to get you out of some situations:
 - Loco won't respond -
 - Check that the short/long address bit is set correctly in the CFG variable (CV 29).
 - The loco might be in a consist - Press **DEL LOCO**, the locomotive number then **ENTER**.
 - Make sure CV3, 4, 23, 24 are set to a small enough value to allow the loco to accelerate at a reasonable rate
 - Loco won't run on an analog (DC) layout - Check that the DC mode bit is set in the CFG variable (CV 29).

Copyright & Trademarks

Copyright © 1994-2010 NCE Corporation. The identifying product terms Power Cab™, PH-Pro™, ProCab™, and SmartCab™ are trademarks of NCE Corporation. The look and feel of this software and its interaction with the user through the ProCab or SmartCab is copyright NCE Corporation. The distinctive shape of the ProCab™ with LCD and/or thumbwheel is a trademark of NCE Corporation. Digitrax® is a registered trademark of Digitrax® Inc. All other non-NCE brands and product names mentioned are likely to be trademarks or registered trademarks of their respected companies.

Limited Warranty

NCE guarantees that every Power Cab™ DCC System is free from physical defects in material and workmanship for a period of 1 year.

Within the first year full repair or replacement will be made to the original purchaser of any item that has failed due to manufacturer defect. Should the item no longer be produced and the item not repairable a similar item will be substituted at the manufacturer's discretion. The customer pays only shipping to the NCE Warranty Center. Please save your original receipt as a photocopy of it may be requested. NCE returns the items UPS ground unless other arrangements are made in advance.

After the first year a fair and reasonable service charge may be placed on each failed item returned for repair. Should the item no longer be produced and the item not repairable a similar item will be substituted at the manufacturer's discretion. The customer pays shipping to and from the NCE Warranty Center.

This warranty is not valid if the customer has intentionally misused, miswired, performed any unauthorized alterations to the product or removed any product protection devices (such as heat shrink wrapping from decoders). In this case a service charge will be applied for all repairs and replacements. To protect the warranty, please contact the Warranty Center for authorization prior to altering any product. In no event will NCE's liability exceed the price paid for the product from direct, indirect, special, incidental or consequential damages resulting from the use of the product, its accompanying software or its documentation. NCE makes no warranty or representation, expressed, implied or statutory with respect to its products or the contents or use of this documentation and accompanying software and specifically disclaims its quality, performance, merchantability, or fitness for any particular purpose. NCE reserves the right to revise or update its products, software, or documentation without obligation to notify any individual or entity.

Please contact the Warranty Center for specific shipping instructions and any service charges before returning any product for service. Address all inquiries to:

NCE Warranty Center
82 East Main St.
Webster, New York 14580
Phone: 585-265-0230 Fax: 585-265-0234



FCC Statement

This NCE product complies with the limits for a Class B digital device, pursuant to Part 15 of the FCC rules. These limits are designed to provide reasonable protection against harmful interference in a residential installation. This equipment generates, uses and can radiate radio frequency energy and, if not installed and used according to the instructions, may cause harmful interference to radio communications. However, there is no guarantee that interference will not occur in a particular installation. Keep in mind that by FCC rules, **all** electronic equipment must accept any interference, including interference that may cause undesired operation. If this equipment does cause harmful interference to radio, or television reception, which is found by turning the equipment off and on, the user is encouraged to correct the interference by one or more of the following measures:

- Reorient or relocate the receiving antenna
- Increase the separation between the equipment and the device
- Connect the equipment to an outlet other than the receiver's
- Consult a dealer or an experienced radio/TV technician for assistance

About NCE

NCE has been manufacturing DCC Products on an OEM basis since 1993. Originally we offered only "chip sets" that contained software enabling other DCC manufacturers to build DCC systems. As time went on some of those manufacturers asked us to first supply partial assemblies then complete assemblies in addition to the chip sets. This has helped NCE to grow into a full time electronic design and manufacturing firm devoted entirely to the development and sale of products for the control of model railroads. We build an amazing array of products for both our own customers and other DCC manufacturers. We keep labor costs low by utilizing modern automated robotic assembly for most products.

Our product designer is Jim Scorse. Jim models the Erie Railroad in O-Scale and has a long history in model railroading. He has numerous patents in the area of digital imaging, video and computer network data communications over noisy channels. Jim is active in the Layout Design SIG as well as 30 years with the "Tuesday Night Gang", (round robin model railroad club) and is probably one of the only active model railroaders among all the DCC manufacturers.

MENU NAVIGATION CHART

Press PROG/ESC Key to cycle through menu listings, then press ENTER to

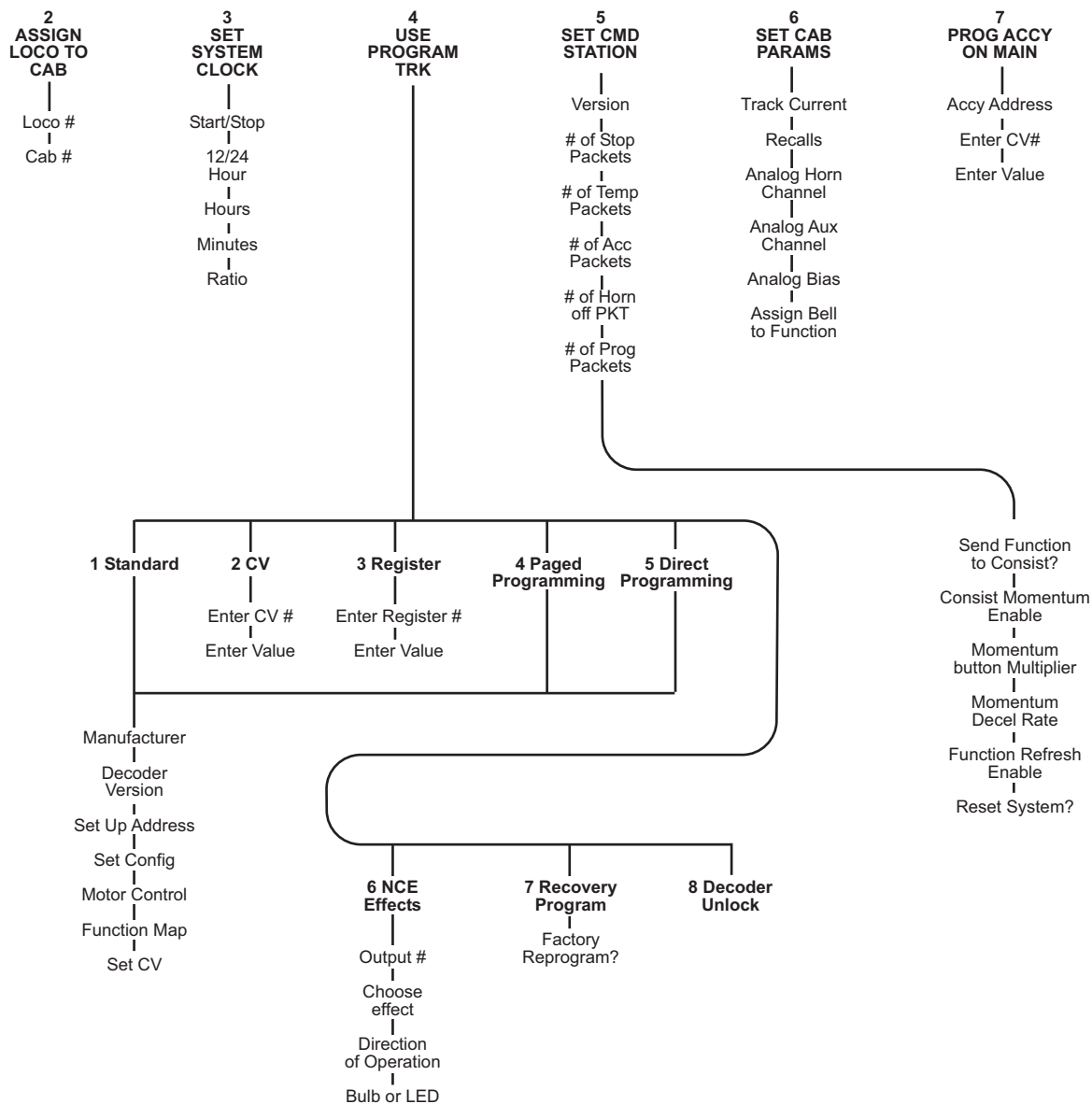

NAVIGATION CHART - Part 2

Press the arrow keys to move through menu listings, then press ENTER to cycle through listing choices

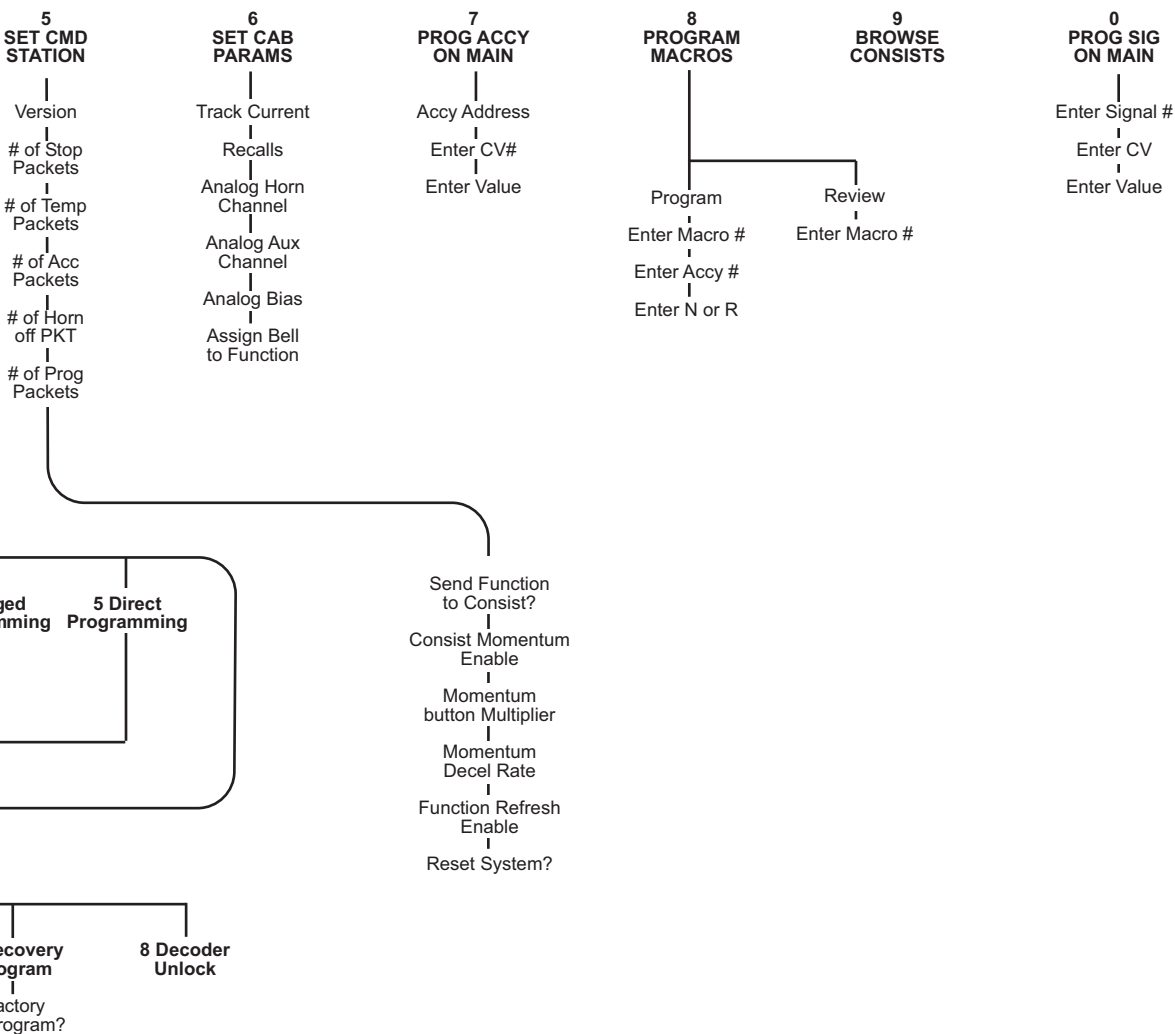

MENU NAVIGATION CHART - PT.1

Press PROG/ESC key to cycle through menu listings, then press ENTER to cycle through listing choices.

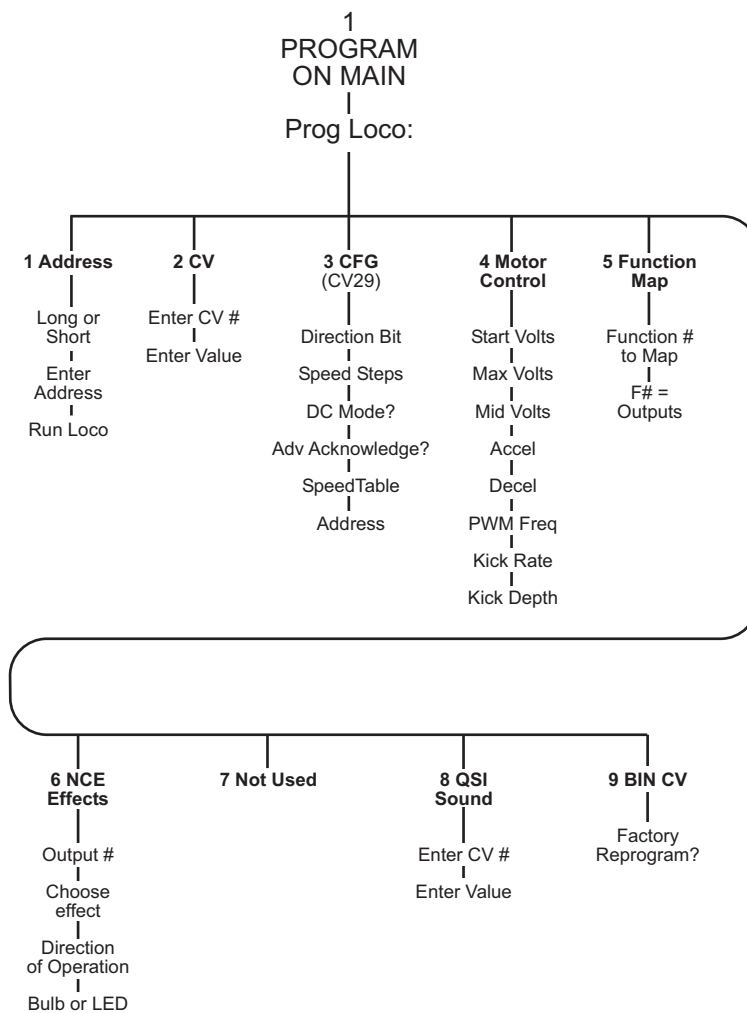



NCE Corporation
82 East Main St.
Webster, NY 14580
(585) 265-0230
ncedcc.com



05240301